

PROFESSIONAL EQUIPMENT
CATTALOGUE



Martellato

PROFESSIONAL EQUIPMENT

PASTRY, ICE CREAM & BAKERY

 Martellato



La nostra VISION

Essere ambasciatori del Made in Italy nel mondo, offrendo prodotti che permettano ai pasticceri di esprimere al meglio il loro talento.

Our VISION

Being ambassadors of Made in Italy all over the world, by offering products that allow pastry chefs to express their talent at their best.



7000 PRODOTTI nel nostro catalogo

Una gamma completa, in costante crescita, studiata e realizzata per soddisfare le esigenze dei professionisti. Il nostro catalogo, dedicato alle attrezzature da laboratorio pensate per i pasticceri ed adatte a tutti i professionisti, raccoglie un'ampia gamma di articoli tradizionali ed innovativi e vuole rappresentare il punto di riferimento per i diversi settori del comparto food.



7000 PRODUCTS in our catalogue

A complete range, constantly growing, designed and built for meet the needs of professionals. Our catalog, dedicated to laboratory tools designed for pastry chefs and suitable for all professionals, collects a wide range of traditional and innovative articles and wants to represent the reference point for the different sectors of the food industry.

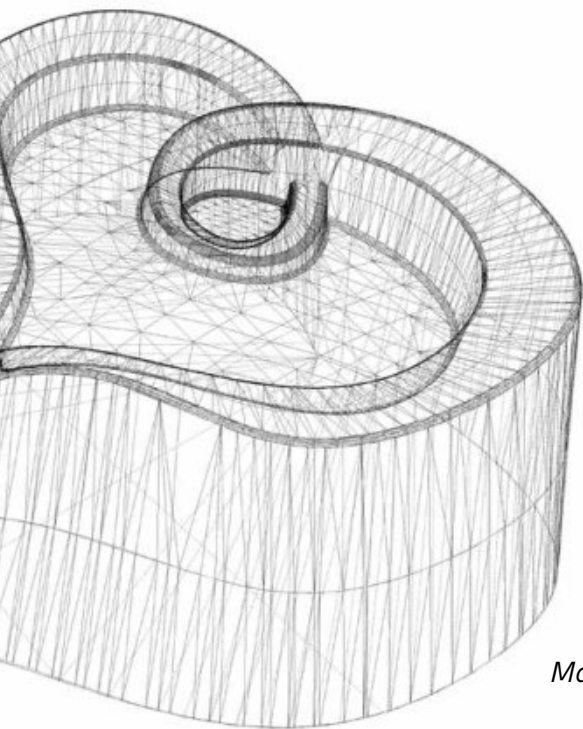

MADE IN ITALY significa innovazione e design

Per noi, il "Made in Italy" è l'identità che esprime i valori del territorio e una particolare attenzione verso i prodotti. L'accurata scelta dei fornitori e delle nostre lavorazioni ci permette di offrire dei prodotti di alta qualità.

MADE IN ITALY means innovation and design

Made in Italy is for us the identity that expresses the values of the territory and a particular attention to products. The careful choice of suppliers and our manufacturing allows us to offer high quality products.



Produzioni e materiali SOSTENIBILI

L'impegno verso il Pianeta è parte della nostra filosofia e delle nostre attività quotidiane.

I **PROCESSI DI PRODUZIONE** più efficienti, insieme a sistemi di gestione ambientale migliori, possono ridurre in maniera significativa l'inquinamento, i rifiuti e i consumi.

INIEZIONE: grazie a questo sistema vengono azzerati gli scarti produttivi, in quanto la materia prima viene utilizzata interamente. Inoltre, l'alta produttività degli impianti comporta una riduzione dei consumi.

TERMOFORMATURA: la nostra produzione consente, contemporaneamente e con brevi cicli di lavoro, di stampare articoli di forme e dimensioni diverse, valorizzando gli scarti utilizzandoli come materia prima secondaria per altre produzioni.

TAGLIO LASER: consente lavorazioni precise che utilizzano al massimo la materia prima, ottimizzando la produzione e riducendo gli scarti.

Utilizzo di **MATERIALI ECOLOGICI E RICICLABILI** per ridurre l'impatto ambientale.

Oltre ad essere riciclati, sono ecologici in quanto riciclabili al 100%, quando consentito dalla normativa alimentare. Diventano così risorse per nuove produzioni. Anche eventuali scarti produttivi vengono utilizzati in altre produzioni.



SUSTAINABLE productions and materials

We see the commitment to the Planet as a part of our philosophy and our daily activities.

*The most efficient **PRODUCTION PROCESSES** along with better environmental management systems can significantly reduce pollution, waste and consumptions.*

***INJECTION:** this system allows to eliminate production waste, because the raw material is entirely used. Furthermore, the high productivity of the industrial installations guarantees a reduction in consumption.*

***THERMOFORMING:** our production allows, at the same time and with short working cycles, to print articles of different shapes and sizes, enhancing the value of waste by using them as secondary raw material for other productions.*

***LASER CUTTING:** it allows precise workings that uses at most the raw material by optimizing production and reducing waste.*

*Use of **ECOLOGICAL AND RECYCLABLE MATERIALS** in order to reduce the environmental impact. In addition to being recycled, they are environmentally friendly as 100% recyclable, when permitted under food regulations. In this way they become resources for new productions. Any production waste is also used in other productions.*



La nostra SCELTA

Tradizione ed innovazione, insieme a ecosostenibilità e qualità, caratterizzano la filosofia dei prodotti del nostro catalogo.

Da sempre rivolgiamo il nostro impegno nella **ricerca di materiali e sistemi produttivi tecnologicamente innovativi**, seguendo la produzione degli articoli in modo puntuale e totale, dall'acquisto diretto delle materie prime al **controllo della produzione**.

Oggi questo non basta più: la ricerca è rivolta anche a trovare **sistemi innovativi per migliorare la qualità** ed il valore dei processi produttivi nel rispetto dell'ambiente.

Our CHOICE

Tradition and innovation, along with environment sustainability and quality, characterize the philosophy of the products of our catalogue.

*We have always been committed to **researching technologically innovative materials and production systems** by following the production in a timely and total manner, from direct purchase of raw materials to **production control**.*

*Today this is not enough anymore: the research is also aimed at finding **innovative systems in order to improve the quality and value of production processes**, while respecting the environment.*



REDUCE

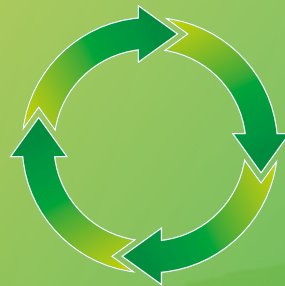

REUSE



RECYCLE

Compiendo queste azioni, ogni azienda grande o piccola, ogni persona, tutti possiamo contribuire alla salvaguardia del pianeta.

Any company, either big or small, any person, all of us can contribute in safeguarding the planet.



Qualità certificata

Qualità e sicurezza di tutti i nostri prodotti e servizi, così come specializzazione, ricerca e formazione sono costantemente controllate per garantire standard elevati nel rispetto delle Normative Europee sulla sicurezza alimentare, ambientale e gestione aziendale.

Martellato è un'azienda con sistema di qualità certificato ISO 9001:2015.

Certified quality

The quality and safety of all our products and services, as well as the specialization, research and training are constantly monitored to guarantee high standards in accordance with European regulations of food and environmental safety and business management.

Martellato is a company with certified quality system ISO 9001: 2015.

Bureau Veritas Certification



MARTELLATO SRL

Via Rovigo, 1/b-35010 Vigonza - Italy

Sede Oggetto di certificazione:
Via Rovigo, 1/b-35010 Vigonza - Italy

Bureau Veritas Italia S.p.A. certifica che il sistema di gestione dell'organizzazione sopra indicata è stato valutato e giudicato conforme ai requisiti della norma di sistema di gestione seguente

ISO 9001:2015

Campo di applicazione

**Progettazione e Produzione di forme, espositori, sac a poche, stampi e dispositivi monouso per le pasticcerie artigianali e il settore Ho.Re.Ca.
Progettazione e distribuzione di attrezzature manuali per le pasticcerie artigianali e settore HO.RE.CA. Commercializzazione di paste e coloranti.**

Settore IAF: 14,17,29	
Data della certificazione originale:	10-Dicembre-2019
Data di scadenza precedente ciclo di certificazione:	NA
Data dell'Audit di certificazione / rinnovo:	12-Dicembre-2020
Data d'inizio del presente ciclo di certificazione:	10-Dicembre-2019
Soggetto al continuo e soddisfacente mantenimento del sistema di gestione questo certificato è valido fino al:	09-Dicembre-2022
N° Certificato - Versione: IT294993 - 2	Data di emissione: 15-Gennaio-2021



GIORGIO LANZAFAME - Local Technical Manager



SGIQ N° 009A
Membro degli Assodi di Mutual Recognition CA, IAF e IAC
Operatory of CA, IAF and IAC Mutual Recognition Agreements

Indirizzo dell'organismo di certificazione:
Bureau Veritas Italia S.p.A., Viale Monza, 347 - 20126 Milano, Italia

Ulteriori chiarimenti sul campo di applicazione di questo certificato e sui requisiti applicabili della norma del sistema di gestione possono essere ottenuti consultando l'organizzazione.
Per controllare la validità di questo certificato consultare il sito www.bureauveritas.it



1/1

7

INDEX

CHOCOLATE	10
SEMIFREDDO & BAKING	186
ICE CREAM	252
SPECIAL EQUIPMENT	274
PROFESSIONAL TOOLS	320
DECORATION	378
CREATIVE COLORS	398
BANQUETING	418

CHOCOLATE

PRALINE

ALTA PRODUTTIVITÀ grazie alla misura più grande: 275x175 mm
HIGH PRODUCTIVITY thanks to the largest size: 275x175 mm

SUPERFICIE LISCIA per trasferire massima lucentezza alle praline
SMOOTH SURFACE to transfer maximum brightness to the pralines

DESIGN testato per assicurare risultati perfetti
Tested DESIGN to ensure perfect results

MADE IN ITALY, sinonimo di qualità
MADE IN ITALY, synonymous of quality





Gli oltre 250 stampi in policarbonato prodotti da Martellato nascono dalla continua ricerca, che abbinata alla alta qualità dei materiali, dà vita a strumenti altamente professionali adatti ai più esigenti cioccolatieri e pasticceri.

The over 250 polycarbonate moulds produced by Martellato are the result of a continuous research, which combined with the high quality of the materials, gives life to highly professional tools suitable for the most demanding chocolatiers and pastry chefs.

Policarbonato - Polycarbonate
Stampo - Mould: 275x175 mm

Su richiesta: personalizzazioni di modelli e misure - in versione BPA FREE
On request: customization of models and sizes - in BPA FREE version



PRALINE



MA1002
 Ø 30 h19mm
 28 pcs ~12 gr



MA1011
 50x25 h15mm
 21 pcs ~9 gr



MA1012
 54x24 h16mm
 21 pcs ~9 gr



MA1019
 25x25 h23mm
 40 pcs ~13 gr



MA1025
 33x22 h20mm
 30 pcs ~15 gr



MA1029
 39x28 h17mm
 32 pcs ~12 gr



MA1032
 38x22 h15mm
 32 pcs ~10 gr



MA1037
 Ø 29 h21mm
 40 pcs ~8 gr



MA1046
 37x31 h16mm
 28 pcs ~12 gr



MA1064
 35x23 h16mm
 36 pcs ~9 gr

Policarbonato - Polycarbonate
 Stampo - Mould: 275x175 mm



MA1074
38x28 h18mm
30 pcs ~15 gr



MA1082
35x20 h17mm
30 pcs ~12 gr



MA1091
Ø 28 h23mm
40 pcs ~10 gr



MA1094
Ø 30 h22mm
28 pcs ~14 gr



MA1281
17x12 h5mm
130 pcs ~1 gr



MA1293
Ø 23 h21mm
28 pcs ~12 gr



MA1303
27x27 h18mm
28 pcs ~11 gr



MA1335
35x22 h15mm
30 pcs ~7 gr



MA1350
Ø 25,5 h21,5mm
30 pcs ~11 gr



MA1521
Ø 28 h18mm
28 pcs ~10 gr



MA1527
31x24 h13mm
35 pcs ~8 gr



MA1529
32x22 h15mm
42 pcs ~8 gr



MA1530
Ø 26 h19mm
40 pcs ~9 gr



MA1604
30x25 h15mm
24 pcs ~9 gr



MA1606
30x30 h12mm
24 pcs ~9 gr





MA1607
 Ø 28 h17,5mm
 24 pcs ~9 gr



MA1609
 30x23 h18mm
 24 pcs ~9 gr



MA1610
 Ø 29 h18mm
 24 pcs ~9 gr



MA1611
 Ø 30 h15mm
 24 pcs ~9 gr



MA1612
 38x30 h15mm
 20 pcs ~9 gr



MA1616
 27x27 h13mm
 28 pcs ~9 gr



MA1617
 31x23 h12mm
 24 pcs ~9 gr



MA1618
 Ø 30 h20mm
 24 pcs ~9 gr



MA1619
 29x29 h12mm
 18 pcs ~9 gr



MA1620
 33x25 h12mm
 24 pcs ~8 gr



MA1621
 33x33 h15mm
 24 pcs ~9 gr



MA1622
 30x24 h12mm
 24 pcs ~9 gr



MA1624
 28x32 h15mm
 32 pcs ~8 gr



MA1625
 30x18 h15mm
 30 pcs ~8 gr



MA1626
 31x20 h16mm
 30 pcs ~7 gr

PRALINE



MA1627
35x20 h15mm
30 pcs ~7 gr



MA1629
30x18 h15mm
30 pcs ~8 gr



MA1631
30x18 h15mm
30 pcs ~7 gr



MA1632
30x18 h15mm
30 pcs ~8 gr



MA1633
Ø 26 h15mm
35 pcs ~8 gr



MA1636
30x30 h15mm
24 pcs ~8 gr



MA1637
32x24 h15mm
30 pcs ~8 gr



MA1638
34x25 h15mm
30 pcs ~8 gr



MA1640
48x18,5 h19mm
16 pcs ~9 gr



MA1800
21x21 h18,5mm
28 pcs ~8 gr



MA1801
26x20 h21mm
28 pcs ~8 gr



MA1802
Ø 23 h18,5mm
28 pcs ~7 gr



MA1803
26x20 h21mm
28 pcs ~8 gr



MA1804
Ø 25 h18,5mm
28 pcs ~8 gr



MA1900
29x19 h16mm
28 pcs ~8 gr





MA1901
27x23 h14mm
28 pcs ~8 gr



MA1903
28x20 h17mm
28 pcs ~7 gr



MA1904
30x20 h17,5mm
28 pcs ~8 gr



MA1905
30,5x19,5 h18mm
28 pcs ~8 gr



MA1907
29,5x19 h17mm
28 pcs ~7 gr



MA1963
Ø 27 h20mm
30 pcs ~9 gr



MA1964
Ø 27 h20mm
30 pcs ~9 gr



MA1965
25x25 h15mm
30 pcs ~9 gr



MA1966
25x25 h15mm
30 pcs ~9 gr



MA1968
25x25 h15mm
30 pcs ~9 gr



MA1969
40x20 h18mm
30 pcs ~8 gr



MA1970
40x18 h15mm
30 pcs ~9 gr



MA1971
40x18 h16mm
30 pcs ~8 gr



MA1972
26x26 h20mm
30 pcs ~7 gr



MA1980
25x25 h13mm
24 pcs ~9 gr



MA1981
Ø 35 h15mm
24 pcs ~10 gr



MA1982
28x28 h16mm
28 pcs ~11 gr



MA1983
24x24 h18mm
28 pcs ~10 gr



MA1984
40x42 h 16mm
15 pcs ~10gr



MA1985
41x24 h20mm
20 pcs ~10 gr



Polycarbonato - Polycarbonate
Stampo - Mould: 275x175 mm



MA1986
30x30 h11mm
28 pcs ~11 gr



MA1987
35x23 h17mm
24 pcs ~10 gr



MA1988
30x30 h8mm
24 pcs ~8 gr



MA1989
Ø 35 h8mm
24 pcs ~8 gr



MA2003
20x20 h16mm
28 pcs ~6 gr



PRALINE SET



MA1958
30x24 h18mm
5x6 pcs ~10 gr



MA1961
30x25 h25mm
5x6 pcs ~8 gr

LOVE PRALINE



MA1513
34x33 h11mm
28 pcs ~7 gr



MA1526
30,5x28 h16,5mm
35 pcs ~8 gr



MA1962
31x27 h14mm
30 pcs ~8 gr



MA1613
40x42 h15mm
15 pcs ~9 gr



MA1993
33x33 h 15mm
24 pcs ~10gr



Contemporary

Forme moderne che rispondono alle più attuali esigenze, caratterizzano le praline della linea Contemporary. Modelli che si prestano a molteplici interpretazioni, di gusto e stile.

Modern shapes that adapt to the most current needs, characterize the pralines of the Contemporary line. Models that are suited to multiple interpretations, to meet different preferences.

Polycarbonate Moulds
275x175 mm





ROCKET

MA1044

Ø 23 h 29 mm
Prod. 28 pcs ~ 9 gr



THIMBLE

MA1045

Ø 23 h 28,5 mm
Prod. 28 pcs ~ 11,5 gr



DROP

MA1011

50x25 h15mm
Prod. 21 pcs ~9 gr



BLOOM

MA1012

54x24 h16mm
Prod. 21 pcs ~9 gr

Contemporary



Eleganza e stile contemporaneo sono le principali caratteristiche che contraddistinguono le **nuove praline tronchetto**: 4 diverse interpretazioni di una forma senza tempo per consentire **creazioni classiche e moderne**.

Elegance and contemporary style are the main features that distinguish the **new log pralines**: 4 different interpretations of a timeless shape to allow **classic and modern creations**.

Polycarbonate Moulds
275x175 mm



TURN

MA1013

40x19 h 16 mm
Prod. 25 pcs ~ 10 gr



TWIST

MA1014

39,5x19 h 16 mm
Prod. 25 pcs ~ 11 gr



FLAT

MA1015

40x18 h 16 mm
Prod. 25 pcs ~ 11 gr



PILL

MA1016

40,5x18 h 16 mm
Prod. 25 pcs ~ 10 gr

architecture

Ispirate dalle linee armoniose delle volte architettoniche, le nuove praline riproducono i diversi stili. Come i più famosi architetti potrete realizzare vere e proprie opere d'arte.

Inspired by the harmonious lines of architectural vaults, the new pralines reproduce different styles. Like the most famous architects, you can create real works of art.

Polycarbonate Moulds
275x175 mm

PAVILION

MA1041
27x27 h 20 mm
Prod. 28 pcs ~ 10 gr



VAULT

MA1042
26,5 x 26,5 h 20 mm
Prod. 28 pcs ~ 9 gr





CROSS

MA1043
26,5 x 26,5 h 18 mm
Prod. 28 pcs ~ 11 gr

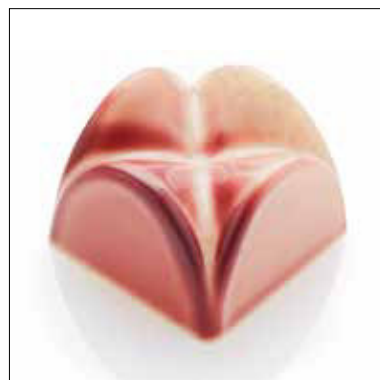



So Sweet!

Ispirate alle forme più famose della pasticceria, le nuove praline rappresentano un modo diverso di creare con il cioccolato. Adatte a diverse interpretazioni, sono perfette in ogni occasione.

Inspired by the most famous shapes of the pastry world, the new pralines represent a different way of creating with chocolate. Suitable for different interpretations, they are perfect for any occasion.

Polycarbonate Moulds

275x175 mm



SWEET 1

MA1021

Ø 32 h 23 mm
Prod. 25 pcs ~ 10 gr



SWEET 2

MA1022

Ø 32 h 21 mm
Prod. 25 pcs ~ 11 gr



SWEET 3

MA1023

Ø 32 h 19,5 mm
Prod. 25 pcs ~ 11 gr



SWEET 4

MA1024

Ø 33 h 22 mm
Prod. 25 pcs ~ 10 gr



Double

A TASTY PRALINE EXPERIENCE



Double

Doppia forma, doppio gusto

L'incontro di forme e gusti in un cioccolatino pensato per una nuova esperienza sensoriale. La forma delle praline attrae, ma ciò che conquista è la possibilità di diversificare il ripieno creando armonie di gusto, oltre che cromatiche. Originali accostamenti che sapranno sorprendere.

Double shape, double taste

Shapes meet tastes in a chocolate praline designed for a new sensory experience. The shape of the pralines might attract, but the real conquer is the possibility of diversifying the filling by creating taste harmonies as well as colors. Original combinations that will surprise you.

Polycarbonate Moulds
275x175 mm



DOMES

MA4010
38x26 h 19 mm
Prod. 24 pcs ~ 11gr



CUBES

MA4011
36x25 h 16 mm
Prod. 24 pcs ~ 10gr



HEARTS

MA4012
43x26 h 16 mm
Prod. 20 pcs ~ 11gr

PRISMA

Geometric Pralines



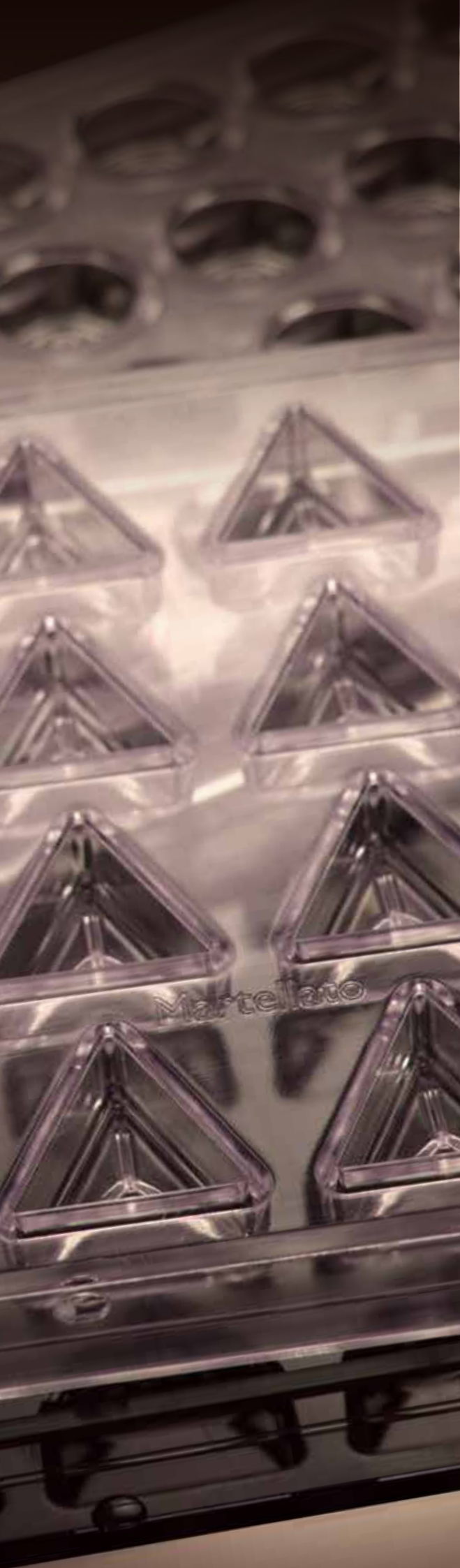

Geometriche e riflettenti come un prisma, le nuove praline dalle linee moderne e regolari rappresentano l'evoluzione nel mondo del cioccolato. Un design inconsueto che gioca con i volumi per lasciare alla creatività il ruolo principale.

Geometric and reflective as a prism, these new pralines represent the evolution in the world of chocolate. An unusual design that plays with volumes in order to leave the leading role to creativity.

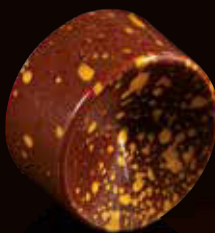

CERCHIO

MA1007

Ø 30 h15,5 mm
Prod. 28pcs ~ 11 gr

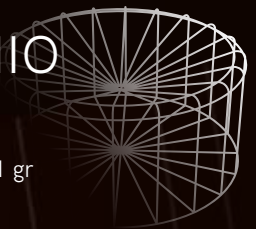

QUADRATO

MA1008

25x25 h15,5 mm
Prod. 28pcs ~ 11 gr



OTTAGONO

MA1010

Ø 30 h15,5 mm
Prod. 28pcs ~ 11 gr



TRIANGOLO

MA1009

33x29 h15,5 mm
Prod. 24pcs ~ 8 gr



Polycarbonate Moulds
275x175 mm



P Y R M I D
P R A L I N E

FORME ESSENZIALI & GEOMETRICHE
ESSENTIAL & GEOMETRICAL SHAPES

La continua ricerca di nuovi soggetti, abbinata alla qualità dei materiali, dà vita a nuove forme che consentono al professionista di ottenere risultati sempre più elevati

Our continuous research into new figures, combined with high quality materials, create new forms that allow the professional to achieve higher results



Polycarbonate Moulds

275x175 mm



CONE

MA4007

25 x 25 h55 mm
Prod. 28pcs ~ 11 gr



OCTAGONAL

MA4006

25 x 25 h55 mm
Prod. 28pcs ~ 11 gr



TRIANGULAR

MA4005

25 x 26 h55 mm
Prod. 28pcs ~ 11 gr

CHOCO *line*



FORME CLASSICHE, ELEGANTI E FUNZIONALI ELEGANT, FUNCTIONAL AND CLASSIC SHAPES

Una linea di stampi in policarbonato caratterizzate da linee essenziali e minimal per praline e snack triangolari, curvi e squadrate. La nuova proposta a triangolo consente creazioni sempre più originali ed innovative. Misure e forme sono studiate per accogliere ganache multiple anche nei formati più essenziali.

A polycarbonate moulds line characterized by essential and minimal lines and used to create triangular, curved and squared pralines and snacks. The new triangle proposal allows always more original and innovative creations. Measurements and shapes are studied in order to insert multiple ganaches, even in more essential formats.

LA PERFEZIONE DELLA SEMPLICITÀ
SI ESPRIME NELLE LINEE ESSENZIALI

PERFECTION OF SIMPLICITY
IS EXPRESSED IN THE ESSENTIAL LINES



Polycarbonate Moulds
275x175 mm

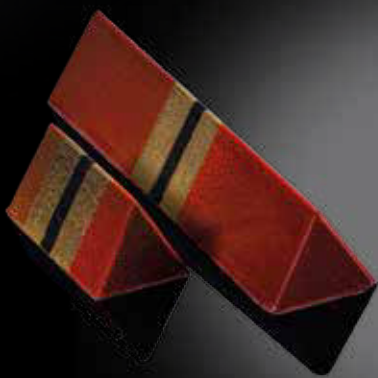

TRIANGLE

MA1999
39x20 h 16 mm
Prod. 27 pcs ~ 7 gr



PLAIN

MA1922
96x22 h 17 mm
Prod. 10 pcs ~ 23 gr

MA1998
39x18 h15,5 mm
Prod. 30 pcs ~ 10 gr

MA1921
96x22 h15,5 mm
Prod. 10 pcs ~ 34 gr



CURVY

MA1997
39x18 h15,5 mm
Prod. 30 pcs ~10 gr

MA1920
96x22 h17 mm
Prod. 10 pcs ~ 34 gr

BONBON



CLASSIC BON

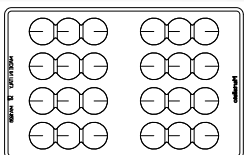

Snack

MA1926
90 x 30,8 h 16,5 mm
Prod. 8 pcs ~ 30 gr

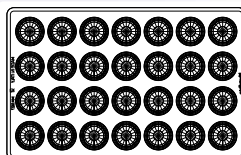

Praline

MA1927
Ø 26 h 23 mm
Prod. 28 pcs ~ 11 gr

Iconiche forme, proposte anche con una **moderna rivisitazione**, sono protagoniste di **stampi per praline e snack** senza tempo.

Iconic shapes, also proposed with a **modern reinterpretation**, are the protagonists of molds for timeless **pralines and snacks**.



Polycarbonate Moulds
275x175 mm



MODERN BON

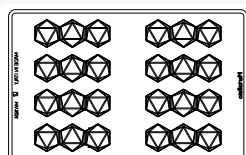

Snack

MA1924

86,6x 31,6 h 18 mm
Prod. 8 pcs ~ 34,5 gr

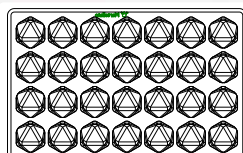

Praline

MA1925

27 x 31 h 18 mm
Prod. 28 pcs ~ 9,5 gr

COCOA



La forma del frutto della **Theobroma cacao** ispira il design di queste praline, che nelle sapienti mani dei pasticceri assumono le sembianze di **cabossidi di cioccolato** che soddisferanno il gusto e la vista. La perfetta planarità delle forme, realizzate con gli stampi in policarbonato, consente la creazione di praline e soggetti 3D.

*The shape of the fruit of **Theobroma cacao** inspires the design of these pralines, which in the skilled hands of the professionals take the appearance of **chocolate cocoa beans** that will satisfy the taste and the sight. The perfect flatness of the shapes, made with polycarbonate moulds, allows the creation of pralines and 3D subjects.*

Polycarbonato - Polycarbonate
Stampi - Moulds: 275x175 mm

THEOBROMA

MA1018
52 x 26 x h14 mm
Prod. 21 pcs ~9 gr



CHOCO FAMILY

Si ispira al cacao il design moderno di praline e tavolette che con i loro grafismi consentono divertenti personalizzazioni per attrarre i golosi.

The modern design of chocolate pralines and bars is inspired by cocoa. Their graphics allow funny customizations to attract the gluttons.



BAR

MA2012

130 x 70 x h8 mm
Prod. 3 pcs ~83 gr

SNACK

MA1923

120 x 24 h11 mm
Prod. 8 pcs ~33 gr

PRALINE

MA3007

26 x 26 x h12 mm
Prod. 28 pcs ~8,5 gr



Diamond

chocolate jewels 





*Stampi in policarbonato
per creare preziose praline di cioccolato*

*Polycarbonate moulds
to create precious chocolate pralines*



Heart

Jems

MA1993

33x33 h 15mm ~10gr
Prod. 24 pcs

MA1994

6 square - 30x30 h 15mm ~11gr
6 oval - 42x24 h 15mm ~10gr
6 round - Ø 32 h 15mm ~10gr

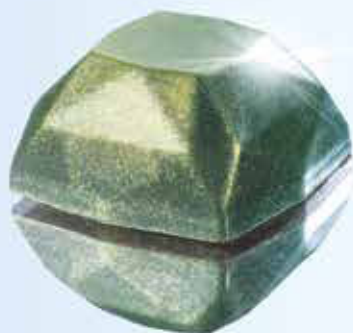
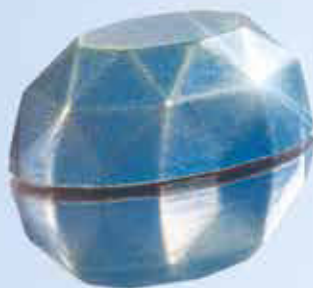

Polycarbonate Moulds

275x175 mm

EVOLUTION

Thinking beyond
chocolate



La collezione Evolution, nata per interpretare le tendenze del momento, si esprime con forme essenziali e geometrie. Le linee si incontrano ed intrecciano nelle nuove tavolette, che richiamano trame e sinuosità, oltre a giochi di volume.

The Evolution collection, created to interpret the trends of the moment, expresses itself with essential shapes and geometries. The lines meet and interlace in the new bars, which recall textures and sinuosity, as well as playing with games of volume.

Polycarbonate Moulds

275x175 mm

SWING

MA2028

BAR - 142 x 68 h 10,5 mm
Prod. 3 pcs ~ 100 gr

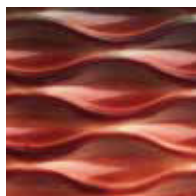

WEAVE

MA2029

BAR - 140 x 70 h 11 mm
Prod. 3 pcs ~ 100 gr



PEAK

MA2027

BAR - 142 x 68 h 12 mm
Prod. 3 pcs ~ 100 gr

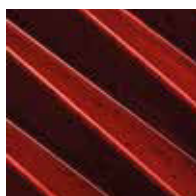



EVOLUTION

MIRROR

MA2022

BAR - 138 x 72 h 9 mm
Prod. 3 pcs ~ 86 gr

KALEIDOS

MA2019

BAR - 130 x 75 h 9 mm
Prod. 3 pcs ~ 85 gr



EXAGON

MA2015

BAR - 140 x 68,5 h 13,5 mm
Prod. 3 pcs ~ 100 gr



SQUARE

MA2014

BAR - 70x70 h 11 mm
Prod. 6 pcs ~ 50 gr



STONE

MA2013

BAR - 70x70 h 11 mm
Prod. 6 pcs ~ 50 gr



ICONICS

Forme che si ispirano alle più iconiche tavolette.
L'interpretazione di ogni cioccolatiere sarà l'elemento
innovativo che sorprenderà e ne differenzierà lo stile.

Shapes inspired by the most iconic bars.
The interpretation of each chocolatier will be the
innovative element that will surprise and differentiate
the style.

Polycarbonate Moulds

275x175 mm

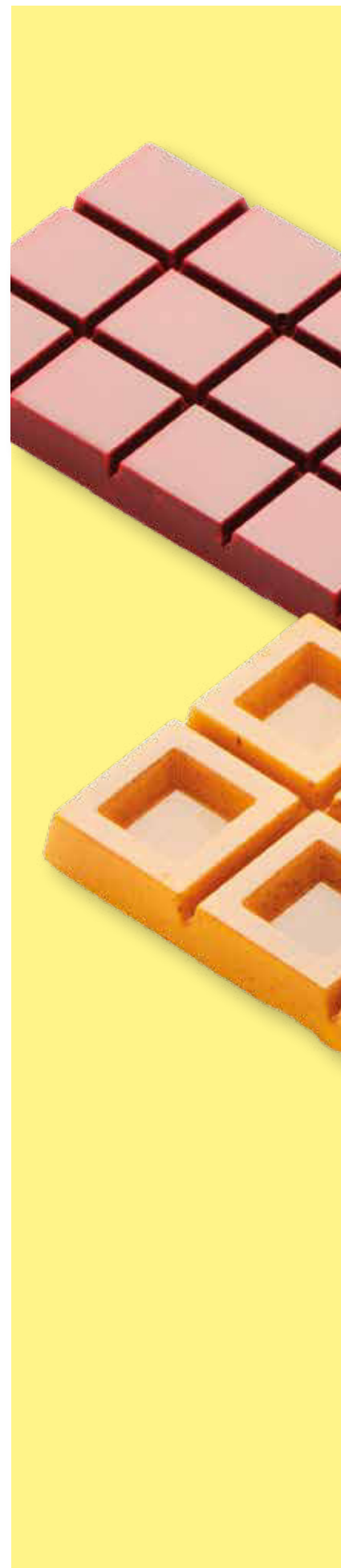

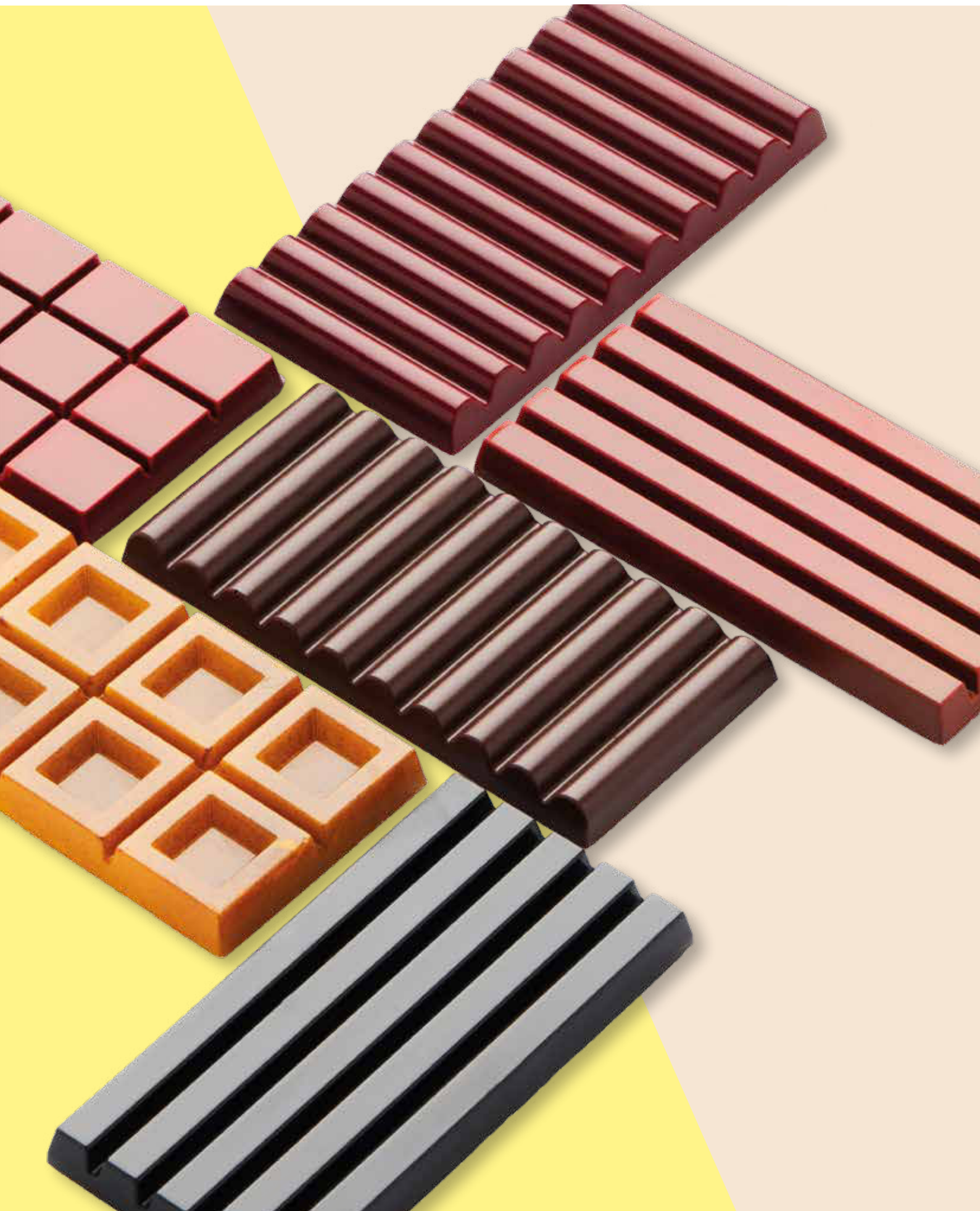



LOG

MA2024

BAR - 140 x 69,5 h 11 mm
Prod. 3 pcs ~ 100 gr

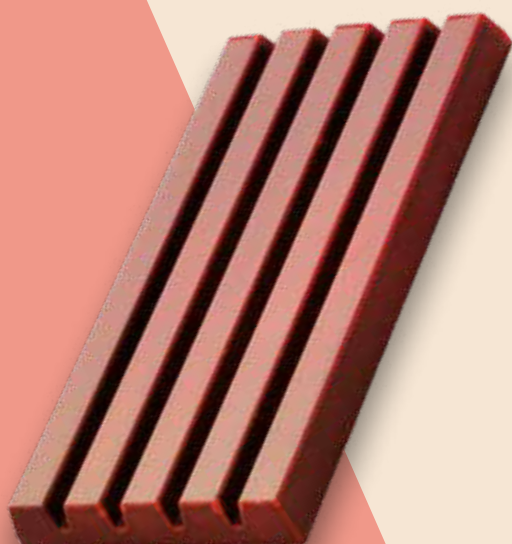

KIT

MA2023

BAR - 138 x 69 h 11 mm
Prod. 3 pcs ~ 100 gr

SLOT

MA2026

BAR - 140 x 70,5 h 10 mm
Prod. 3 pcs ~ 100 gr



BLOCK

MA2025

BAR - 139 x 69,5 h 11,5 mm
Prod. 3 pcs ~ 100 gr

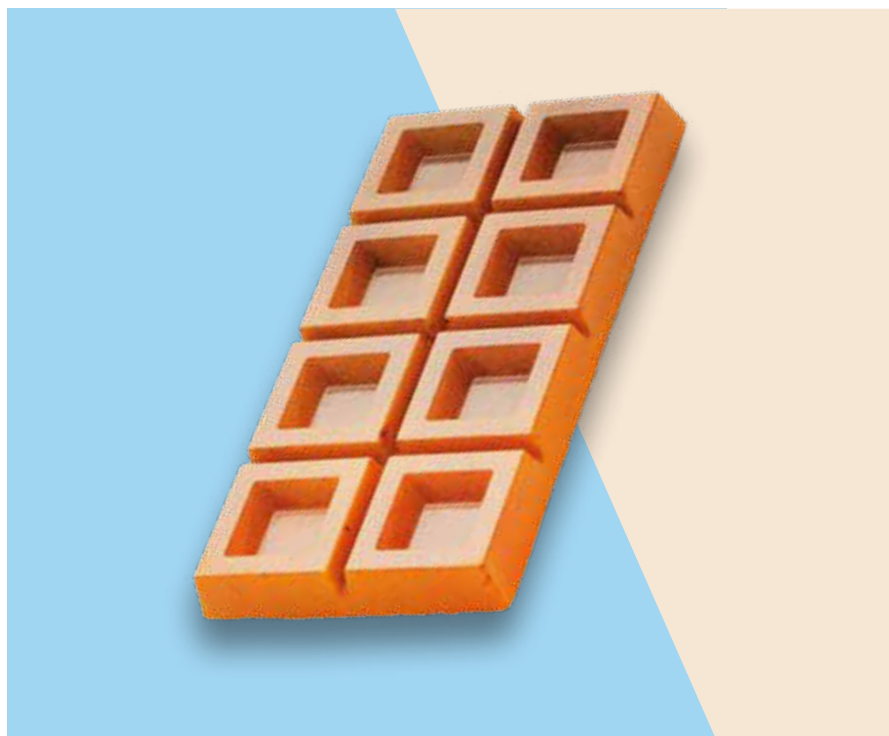

PRESTIGE

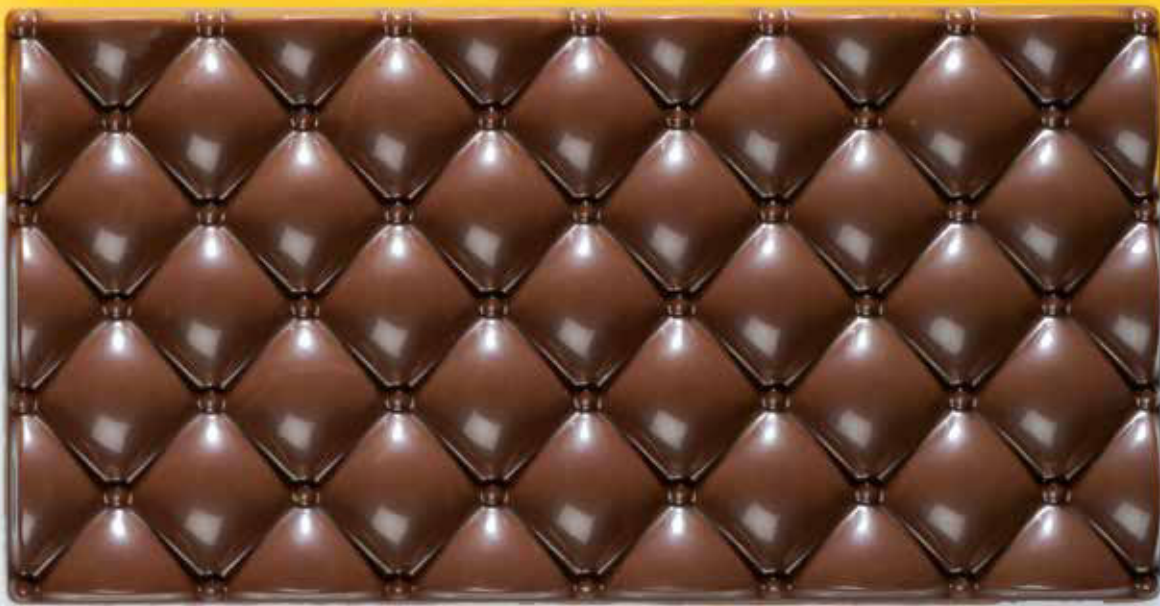

MINI QUILTED

MA2020

BAR - 133 x 70 x h 10 mm
Prod. 3 pcs ~ 82 gr

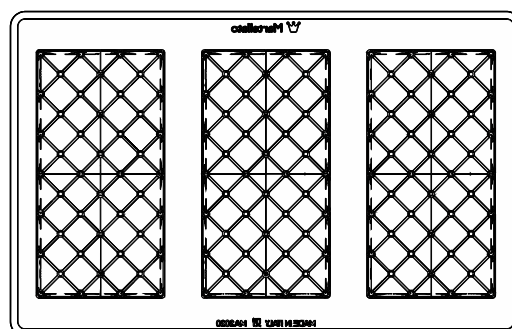

Eleganti ed iconiche nella loro semplicità, le due nuove tavolette della linea Prestige interpretano i gusti senza tempo.

Elegant and iconic in their simplicity, the two new Prestige tablets interpret timeless tastes.

Polycarbonate Moulds

275x175 mm



QUILTED

MA2021

BAR - 132 x 66 h 10 mm
Prod. 3 pcs ~ 80 gr

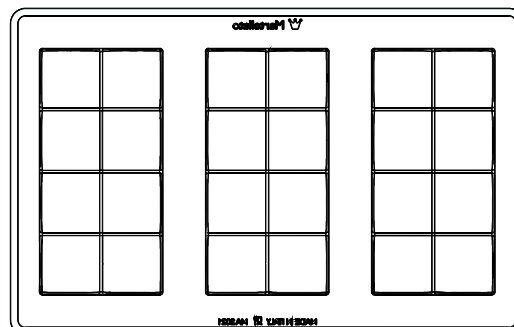

SIGNS



LOVE

MA2017

BAR - 137 X 71 h 9,5 mm
Prod. 3 pcs - 100 gr

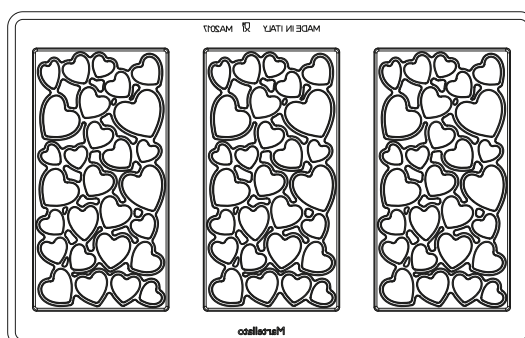

Segni indelebili creano giochi grafici trasformando le tavolette in oggetti d'arte.

Everlasting signs create graphic games by transforming the bars in art objects.

Polycarbonate Moulds

275x175 mm



KUBE

MA2016

BAR - 137 X 72 h 10 mm
Prod. 3 pcs - 100 gr

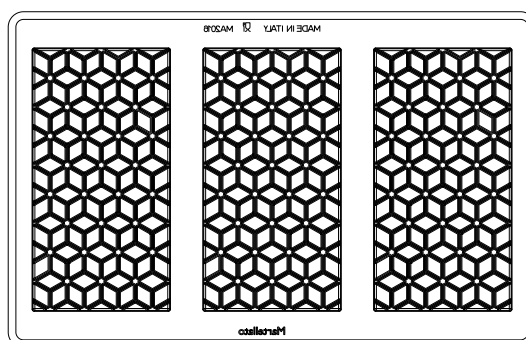

CHOCO *Style*

Tavolette, Snack, Napolitain



Polycarbonate Moulds

275x175 mm

Una gamma completa di stampi in policarbonato per tavolette, snack e napolitain coordinati fra di loro. Grazie alle geometrie che li caratterizzano, i coordinati offrono interessanti possibilità di decorazione, creando raffinate proposte per ingolosire i clienti amanti dello style.

A complete range of polycarbonate moulds for bars, snacks and napolitain coordinated among themselves. Due to the geometries that characterize them, they offer interesting possibilities for creating refined decoration proposals to tempt even the most demanding customers.

MA2009
138x72 h11mm
3 pcs ~80 gr



MA6002
42x25 h6mm
20 pcs ~4 gr



MA1915
123x27 h12mm
8 pcs ~30 gr



MA2008
117x71 h13mm
3 pcs ~80 gr



MA1914
100x26 h16mm
8 pcs ~30 gr

MA6001
31x31 h4,5mm
24 pcs ~4 gr



TAVOLETTE - BARS

POLYCARBONATE MOULDS

275x175 mm

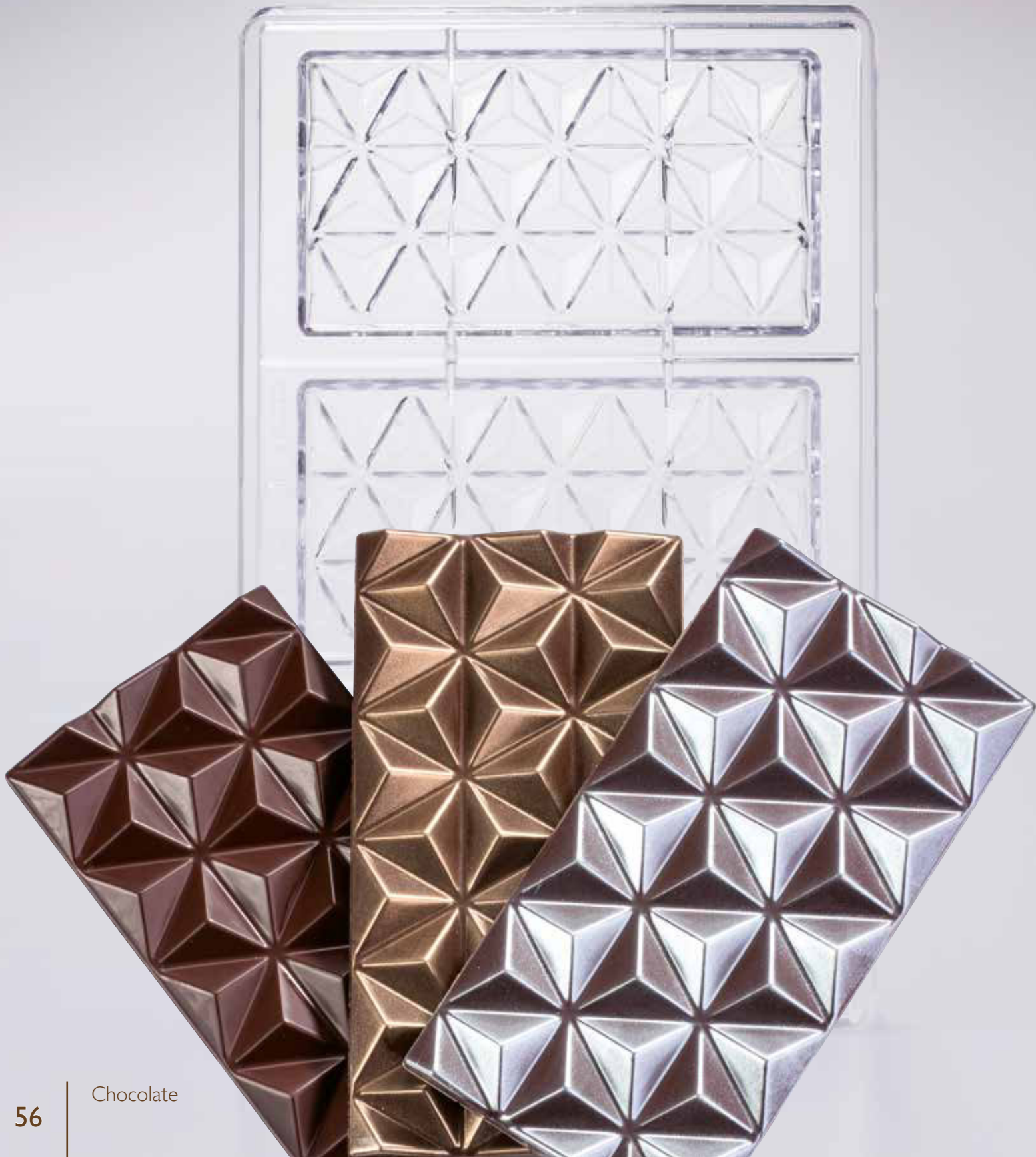

Chocolate



MA2009
138x72 h11mm
3 pcs ~80 gr



MA2008
117x71 h13mm
3 pcs ~80 gr



MA2005
157x78 h7mm
3 pcs ~65 gr



MA2010
132x68 h11mm
3 pcs ~80 gr



MA2000
150x68,5 h 12mm
3 pcs ~110 gr



MA2001
160x75 h8mm
3 pcs ~110 gr



MA2004
130x55 h8mm
4 pcs ~65 gr



MA1807
154x74 h10mm
3 pcs ~125 gr



LIGHT CHOCO BARS

THERMOFORMED MOULDS

Essenziali stampi in plastica termoformata per tavolette che garantiscono risultati perfetti.
Leggeri e pratici, consentono di realizzare artigianalmente esclusive tavolette di cioccolato in modo semplice e veloce.

Essential thermoformed plastic moulds for bars that guarantee perfect results.
Light and practical, they allow to quickly and easily create exclusive handmade chocolate bars.



20TC004
150x70 h 8 mm
Pack 5 pcs ~100 gr



20TC005
130x55 h 8 mm
Pack 5 pcs ~70 gr



20TC006
110x50 h 8 mm
Pack 5 pcs ~45 gr



20TC001
150x70 h10mm
Pack 5 pcs ~100 gr



20TC002
150x70 h10mm
Pack 5 pcs ~100 gr



20TC003
150x70 h10mm
Pack 5 pcs ~100 gr

CHOCOLATE DISPLAYS



Eleganti espositori in plexiglass che consentono di proporre al meglio le vostre tavolette. In diverse misure e altezze, si adattano a tutti gli spazi e gli stili delle diverse attività.

Elegant plexiglass displays that allow you to present your bars at their best. In different sizes and display modes, they adapt to all spaces and different styles of shops.



Vertical
80ET007
 91 x 226 h 73/93 mm
 Cap. ~ 16 pcs



Horizontal
80ET008
 181 x 226 h 43/156 mm
 Cap. ~ 16 pcs (verticale · standing)
 ~ 32 pcs (orizzontale · laying)



Double
80ET009
 180 x 220 h 255 mm
 Cap. ~ 16 pcs (standing)/
 ~ 32 pcs (laying)

Con taschina removibile per inserire grafica personalizzata/ with removable pocket to insert customized graphics



ET003
 310x200 h 400mm



ET004B
 315x410 h 370mm



ET004
 245x300 h 290mm

XL Design

Snack

Hanno il design degli snack e il peso delle tavolette per dare origine ad un nuovo genere di prodotti in cioccolato da condividere.

They have the design of snacks and the weight of bars, to give rise to a new genre of chocolate products to share.

Polycarbonate Moulds

275x175 mm





KITE

MA7000

SNACK/BAR - 200 x 23 h 18 mm
Prod. 4 pcs ~ 62 gr

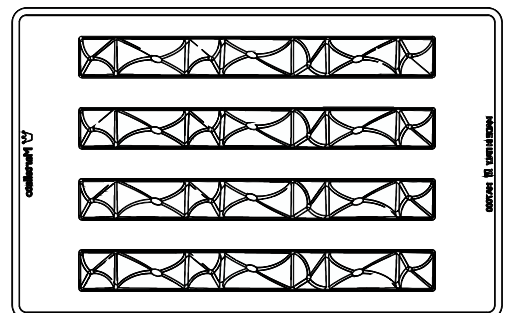



BUBBLE

MA7001

SNACK/BAR 200 x 23 h 17 mm
Prod. 4 pcs ~ 70 gr

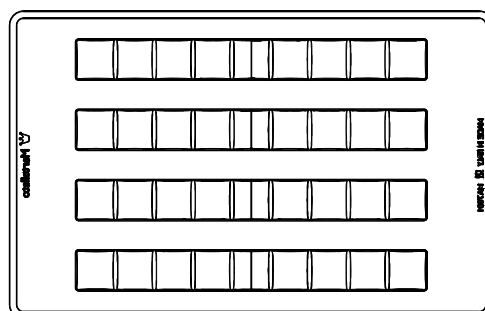



PRISMA

MA7002

SNACK/BAR 202 x 32 h 19 mm
Prod. 4 pcs ~ 70 gr

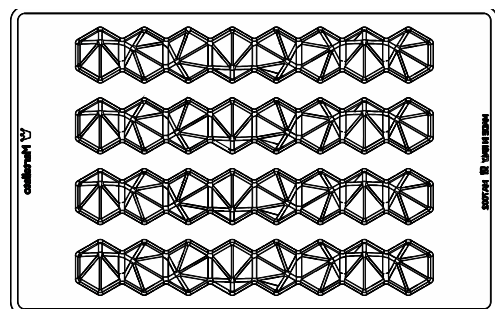

XL Design

Praline

È una pralina o uno snack? Ha la forma della pralina e la grammatura di uno snack, dipenderà da chi lo interpreta dargli la giusta identità.

Is it a praline or a snack? It has the shape of a praline and the weight of a snack. The right identity will depend on who is interpreting it.

Polycarbonate Moulds

275x175 mm





PASTRY

MA1040

PRALINE/SNACK Ø 45 h 33 mm
Prod. 12 pcs ~ 38 gr

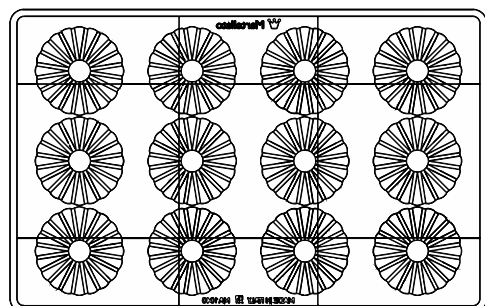



STUD

MA1039

PRALINE/SNACK 45 x 45 h 33 mm
Prod. 12 pcs ~ 34 gr

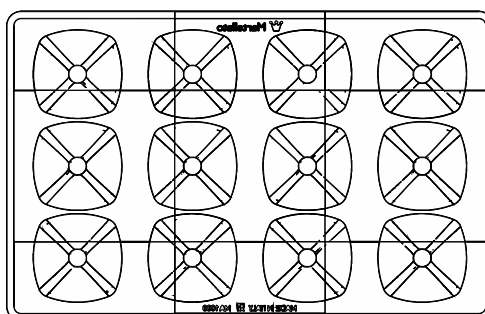



DOME

MA1038

PRALINE/SNACK Ø 43 h 33 mm
Prod. 12 pcs ~ 40 gr

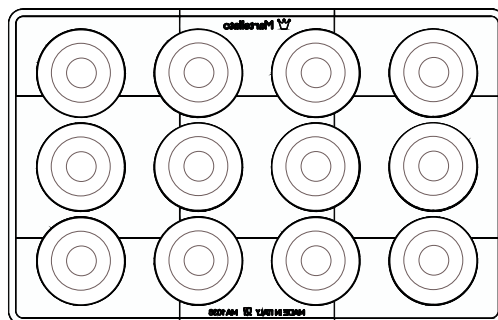

Choco Log

Modern Tradition



Signature by Sergi Vela



CHOCOLOG: condividi la passione!

I nuovi **stampi in polycarbonato** consentono di creare un esclusivo dolce da proporre a chi cerca sempre di sorprendere con le novità.

Una tavoletta/snack al cioccolato con **tanti diversi ripieni da condividere** con gli amici e la famiglia in tutti i momenti di festa.

4 forme ideate in collaborazione con il **Maestro Sergi Vela** per realizzare, grazie anche alle sue ricette, nuove interpretazioni che si aggungeranno a quelle della tradizione.

Un prodotto nuovo e diverso da personalizzare ed esporre nelle vetrine.

CHOCOLOG: share the passion!

The new **polycarbonate moulds** make it possible to create an exclusive cake to offer to those who always try to surprise with novelties.

A chocolate bar/snack with **many different fillings to share** with friends and family in all moments of celebration.

4 shapes created in collaboration with **Maestro Sergi Vela** to create, thanks also to his recipes, new interpretations that will be added to those of tradition.

A new and different product to customize and display in the windows.



Polycarbonato - Polycarbonate
Stampo - Mould: 275x175 mm



FLAT

MA6100
198x35 h23 mm
4 pcs ~160 gr

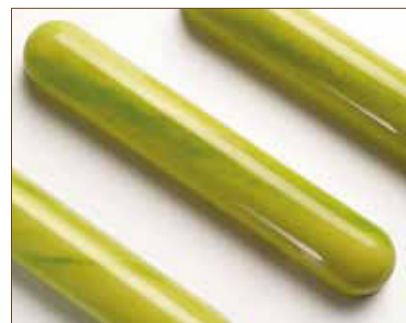

ROUND

MA6101
198x35 h23 mm
4 pcs ~150 gr



CURVY

MA6102
198x35 h23 mm
4 pcs ~150 gr



WAVY

MA6103
198x35 h23 mm
4 pcs ~150 gr

SNACK

POLYCARBONATE MOULDS

Stampo - Mould: 275x175 mm



MA1914

100x26 h16mm - 8 pcs ~30 gr



MA1915

123x27 h12mm - 8 pcs ~30 gr



MA1917

115x24 h15mm - 8 pcs ~30 gr



MA1912

112x32,5 h15,5mm - 8 pcs ~33 gr



MA1913

119x29 h10mm - 8 pcs ~34 gr



MA1916

100x29 h14mm - 8 pcs ~30 gr

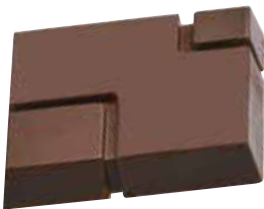

MA1805

58x58 h10mm - 8 pcs ~35 gr



MA1806

119x29 h10mm - 8 pcs ~35 gr



MA1910

99x33 h10mm - 8 pcs ~32 gr



20-D015

129 x h17 mm - 12 pcs ~12 gr

NAPOLITAIN

POLYCARBONATE MOULDS

Stampo - Mould: 275x175 mm



MA6002
42x25 h6mm - 20 pcs ~4 gr



MA6005
45x23 h6mm - 20 pcs ~4 gr



MA6003
Ø 39 h4,5mm - 15 pcs ~4 gr



MA2006
50x26 h3mm - 16 pcs ~5 gr



MA2007
74x33 h5mm - 12 pcs ~13 gr



MA6004
42x27 h5mm - 20 pcs ~4 gr



MA2002
32x32 h4mm - 24 pcs ~5 gr

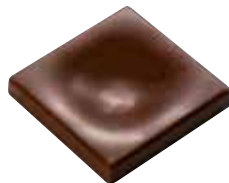

MA6001
31x31 h4,5mm - 24 pcs ~4 gr



choco and the City

Il giro del mondo con il cioccolato. Le 8 più famose città del pianeta si incontrano negli stampi in policarbonato per dare vita a tavolette, snack e napolitain dedicate a chi ama viaggiare.

The world tour with chocolate. The 8 most famous cities on the planet meet together with the polycarbonate moulds to create bars, snacks and napolitain dedicated to those who love to travel.

Policarbonato - Polycarbonate
Stampo - Mould: 275x175 mm



TAVOLETTE - BARS

MA2011

76x150 h 7 mm
3 pcs ~80 gr



NAPOLITAIN

MA6006

34x34 h 4 mm
8x3 pcs ~4 gr



SNACK

MA1919

113x39 h 10 mm
3x2 pcs ~45 gr



Fruttissimi



Un'esplosione di gusto avvolgerà i palati grazie alle **praline a forma di frutta**, riempite con ganache realizzate con i più inaspettati e ricercati ingredienti.

An explosion of taste will surround the palate thanks to the **fruit-shaped pralines**, filled with ganaches made with the most unexpected and refined ingredients.

Polycarbonate Moulds
275x175 mm



PERA
MA1034
44x32 h 17 mm
Prod. 18 pcs ~ 11 gr



ARACHIDE
MA1036
50x23 h 15,5 mm
Prod. 20 pcs ~ 11gr



NOCE
MA1035
37x29 h 17,5 mm
Prod. 18 pcs ~ 11 gr



BANANA
MA1033
64x19 h 15 mm
Prod. 16 pcs ~10 gr



CHOCOFRUIT

Le Praline tridimensionali a forma di frutta
Tridimensional fruit-shaped pralines

Dalla collaborazione con il maestro cioccolatiere Massimo Carnio nascono gli innovativi stampi 3D in policarbonato per realizzare eleganti praline a forma di frutta.

Facili da decorare con differenti tecniche, si riempiono e si svuotano con semplicità, grazie anche ad un dettaglio sul fondo che assicura un lavoro pulito e di maggior precisione. Progettati per permettere un'ottimale cristallizzazione del cioccolato e una facile sformatura, consentono la creazione di sottili camicie per accogliere emozionanti farciture con attenzione anche alla produttività ed alla grammatura dei cioccolatini.

From the collaboration with the master chocolatier Massimo Carnio are born the innovative 3D polycarbonate moulds to create elegant fruit-shaped pralines. Easy to decorate with different techniques, they can be filled and emptied with simplicity, thanks also to a detail on the bottom that ensures a clean and more precise work. Designed to allow optimal crystallization of the chocolate and easy demoulding, they allow the creation of thin shirts to accommodate exciting fillings with attention to the productivity and weight of the chocolates.

Polycarbonate Moulds

275x175 mm

Giulio



Apple

20FRUIT01
Ø 28 h27 mm
~12 gr



PEAR

20FRUIT02
Ø 26 h36 mm
~12 gr



STRAWBERRY

20FRUIT03
Ø 28 h32 mm
~12 gr



LEMON

20FRUIT04
Ø 25 h31 mm
~12 gr



ORANGE

20FRUIT05
Ø 27 h30 mm
~12 gr

PRALINE 3D

Stampo in policarbonato con calamite per la realizzazione di praline 3D, ideale da essere utilizzato con le macchine dosatrici automatiche.

Composto da tre parti: da base e coperchio, dotate di calamite, che definiscono la forma della pralina 3D e da una placca forata per una veloce lisciatura dello stampo dopo lo svuotamento del cioccolato in eccesso.

Polycarbonate mould with magnets for 3D pralines, ideal to be used with automatic dosing machines. Composed of three parts: base and lid, equipped with magnets, which define the shape of the 3D praline and a perforated plate for quick smoothing of the mould after emptying the excess chocolate.

Polycarbonate Moulds

275x175 mm



Sfera - Sphera

20-3D2001

Ø 26 h 26 mm

28 pcs ~8gr

Cuoricino - Heart

20-3D6001

32x18 h 28 mm

28 pcs ~8gr

Ovetto - Egg

20-3D1002

23x32 h 23 mm

28 pcs ~8gr



Sfera - Sphera

20-3D2002

Ø 26 h 26 mm

28 pcs ~8gr



Sfera - Sphera

20-3D2003

Ø 26 h 26 mm

28 pcs ~8gr



Sfera - Sphera

20-3D3001

Ø 26 h 26 mm

28 pcs ~8gr



Sfera - Sphera

20-3D4001

28x24 h 24 mm

28 pcs ~8gr



Ovetto - Egg

20-3D1001

23x30 h 23 mm

28 pcs ~8gr



Ovetto - Egg

20-3D1003

23x30 h 23 mm

28 pcs ~8gr



Cuoricino - Heart

20-3D5001

31x27 h 21 mm

28 pcs ~8gr

[ONE SHOT] FRIENDLY



Le praline 3D One Shot friendly

Studiate con caratteristiche che le rendono adatte ad essere usate dalle macchine dosatrici OneShot, questi stampi in policarbonato per praline, consentono un'alta produttività, tipica anche delle grandi realtà artigianali ed industriali.

One Shot friendly 3D pralines

Designed with features that make them suitable for use with OneShot dosing machines, these polycarbonate moulds for pralines allow high productivity, typical of large artisan and industrial realities.



TRUFFLE

203D01

Ø 26 h 24 mm
Prod. 28 pcs ~ 10 gr



TRUFFLE 2

203D02

Ø 23 h 20,6 mm
Prod. 28 pcs ~ 7 gr

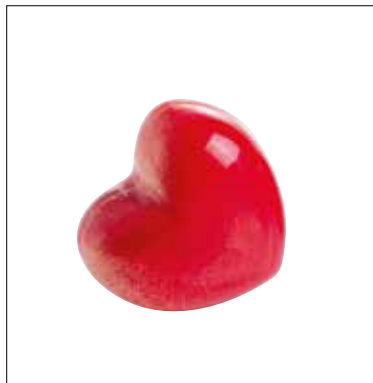

HEART

203D03

30 x 28 h 19 mm
Prod. 28 pcs ~ 11 gr



EGG

203D04

Ø 23,5 h 32 mm
Prod. 28 pcs ~ 10 gr



SEMISPHERE

CREATIVE MOULDS

Perfetti stampi a semisfera, ideali per realizzare eleganti piece, gusci per coperture di semifreddi e altre creative decorazioni. Resistenti e flessibili sono adatti a molteplici utilizzi. Proposte in kit per fornire i diversi diametri necessari alle più fantasiose e ricercate creazioni.

Perfect semispheres moulds, ideal for elegant pieces, semifreddo cakes covers and other creative decorations. As resistant and flexible, they are suitable for multiple uses. Proposed in kits to provide the different diameters needed for the most refined creations.

THERMOFORMED MOULDS



Kit 6 Stampi - Moulds

20SF001 - BIG

- Ø 100 mm - prod 1 pc
- Ø 130 mm - prod 1 pc
- Ø 140 mm - prod 1 pc
- Ø 150 mm - prod 1 pc
- Ø 175 mm - prod 1 pc
- Ø 200 mm - prod 1 pc



Stampi - Moulds:
225x225 mm
175x175 mm

Kit 4 Stampi - Moulds

20SF002 - SMALL

- Ø 50 mm - prod 6 pcs
- Ø 65 mm - prod 4 pcs
- Ø 75 mm - prod 4 pcs
- Ø 90 mm - prod 2 pcs



Stampi - Moulds:
225x225 mm

POLYCARBONATE MOULDS



Polycarbonate Moulds

275x175 mm



20 MM

MA5003
45 cavity
Ø 20 mm

25 MM

MA5007
28 cavity
Ø 25 mm

30 MM

MA5000
24 cavity
Ø 30 mm

35 MM

MA5008
15 cavity
Ø 35 mm

40 MM

MA5004
15 cavity
Ø 40 mm

45 MM

MA5009
12 cavity
Ø 45 mm

50 MM

MA5001
8 cavity
Ø 50 mm

55 MM

MA5010
6 cavity
Ø 55 mm

60 MM

MA5005
6 cavity
Ø 60 mm

80 MM

MA5006
4 cavity
Ø 80 mm

100 MM

MA5002
2 cavity
Ø 100 mm

Chocobrick

Iconiche forme per vivaci realizzazioni in cioccolato pensate per i bambini, ma amate dai nostalgici un po' cresciuti.

Iconic shapes for lively chocolate realisations, designed for kids, but also loved by more nostalgic adults.

Polycarbonate Moulds

275x175 mm



NAPOLITAIN

MA6005
45x23 h 6 mm
Prod. 20 pcs ~4 gr

PRALINE

MA1020
25x25 h 18 mm
Prod. 28 pcs ~ 11gr

SNACK

MA1918
81x27 h 15 mm
Prod. 12 pcs ~30 gr

waves

PRALINE



DESIGN BY
MUSTAFA ZAKI

Le sinuose onde delle dune hanno ispirato le praline della linea Waves. Come il vento rinnova con il suo passaggio le forme, potrete con la vostra creatività dar vita a sempre nuove proposte. Arricchendo le praline con ganache dai sapori orientali, utilizzando spezie ed aromi di paesi lontani, accompagnerete i vostri clienti in fantastici viaggi del gusto.

The sinuous sand dune swells have inspired the pralines of the Waves line. As the wind renews the shapes with its passage, you can give life to new creations with your creativity. Enriching the pralines with oriental flavours ganaches, using spices and aromas from far away countries, you will accompany your customers on fantastic journeys of taste.

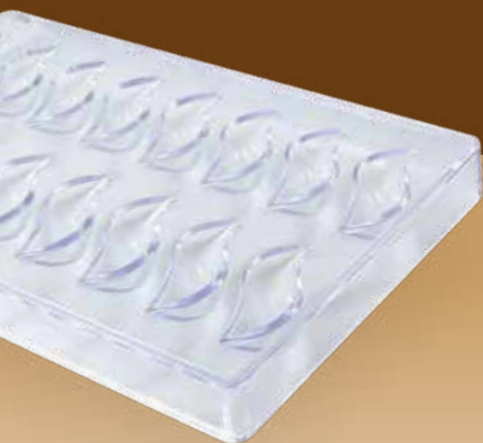

Polycarbonate Moulds
275x175 mm

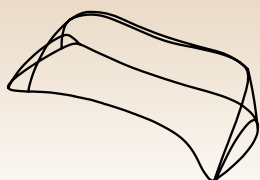

● **MA1003**
26,9 x 59 x h 16 mm
Prod. 14 pcs ~10,4 gr



● **MA1004**
27 x 59 x h 17 mm
Prod. 16 pcs ~7,9 gr



● **MA1005**
24,3 x 61,5 x h 15,4 mm
Prod. 16 pcs ~9,8 gr

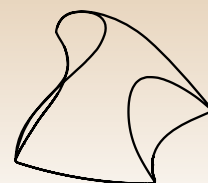

● **MA1006**
43,8 x 38,1 x h 14,1 mm
Prod. 15 pcs ~9,4 gr

MINI *Choco Fill*



Polycarbonate Moulds

275x175 mm

Con i Mini ChocoFill è possibile creare dei piccoli mignon o raffinate praline dall'aspetto originale e invitante.

Using Mini ChocoFill you can prepare small mignon or refined pralines with an original and appetizing look.



20GU009

33x33 h14 mm - Prod. 24 pcs

20GU008

27x27 h31 mm - Prod. 28 pcs



20GU006
Ø 27 h31 mm - Prod. 28 pcs



20GU007
Ø 37 h14 mm - Prod. 15 pcs



20GU005
32x42 h29 mm - Prod. 24 pcs



20GU500
44x56 h39 mm - Prod. 12 pcs



20GU502
44x55 h23 mm - Prod. 12 pcs



20GU003
33x31 h20 mm - Prod. 24 pcs



20GU004
33x33 h23 mm - Prod. 24 pcs



20GU501
Ø 40 h18,5 mm - Prod. 15 pcs



20GU002
Ø 40 h17 mm - Prod. 15 pcs



20GU001
Ø 32 h37 mm - Prod. 20 pcs



ESPO20GU001
380x100 h25 mm
Cap. 20 pcs

Choco à Porter

Funzionali e leggeri stampi in plastica termoformata, consentono di creare golosi lollipop per le merende dei più piccoli o i break dei giovani di ogni età.

Functional and lightweight thermoformed plastic moulds, they allow you to create delicious lollipops for snacks of children or breaks for young people of all ages.



Ovale liscio
Smooth Oval

20L008

5+5 pcs
43x57 h9 mm ~22 gr

Tondo liscio
Smooth Rounded

20L007

5+5 pcs
Ø 50 h9 mm ~25 gr

Tondo tavoletta
Round bar

20L002

8 pcs
Ø 60 h9 mm ~30 gr

Rettangolare tavoletta
Rectangular bar

20L003

8 pcs
50x75 h9 mm ~30 gr

Uovo tavoletta
Egg bar

20L001

8 pcs
52x77 h9 mm ~30 gr



PLEXIGLASS DISPLAYS



EL101
Cap. 56 pcs
345x280 h40 mm



EL306
Satinato - Satin
Cap. 30 pcs
295x70 h125 mm



29003
Cap. 20 lollipop
270x180 h 145mm



EL201
Cap. 66 pcs
450x240 h145 mm

ACCESSORIES

Sacchetti per lollipops
Bags for lollipops

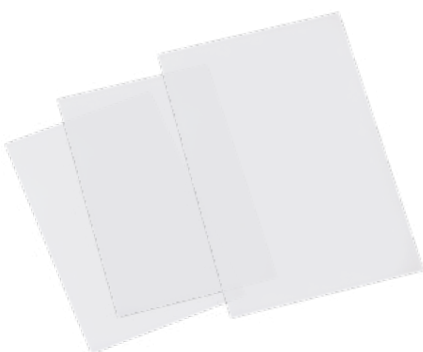

20S004
80x120 mm
200 pcs

20S005
90x130 mm
200 pcs

COMB

Chocolate Decoration Tool

Ideati da **Frank Haasnoot** per creare eleganti **decorazioni in cioccolato**.
Realizzati in acciaio inox, i pettini consentono di produrre numerosi soggetti
con un solo movimento.

Designed by **Frank Haasnoot** to create elegant **chocolate decorations**.
Made of stainless steel, the combs allow you to produce many decorations
with a single touch.

BUTTERFLY

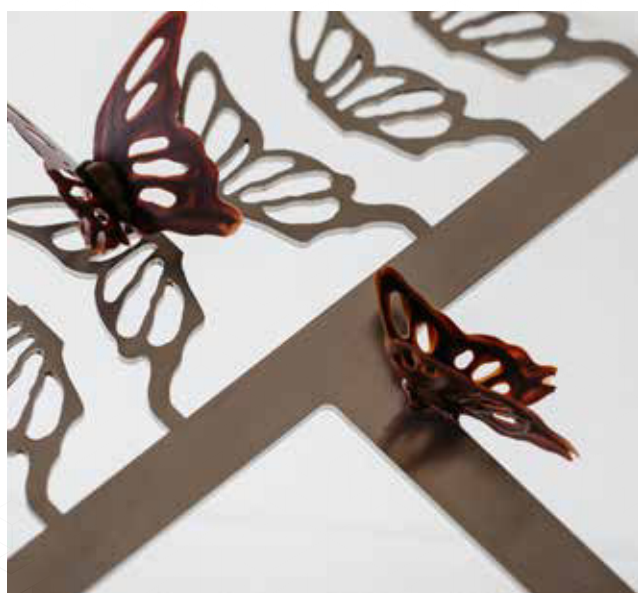

20FH07S - h 60 mm - prod. 3+3 pcs

20FH07L - h 80 mm - prod. 3+3 pcs



Scopri come creare le decorazioni con i comb
Find out how to create decorations with the combs

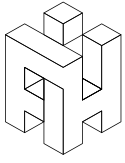

FRANK HAASNOOT for  **Martellato**

Frank Haasnoot



LEAF COMB



LEAF ECLAIR



20FH01S - h 60 mm - prod. 8 pcs
20FH01L - h 80 mm - prod. 8 pcs



20FH04 - h 25 mm - prod. 6 pcs



FEATHER COMB



FEATHER ECLAIR



20FH02S - h 60 mm - prod. 8 pcs
20FH02L - h 80 mm - prod. 8 pcs



20FH05 - h 25 mm - prod. 6 pcs

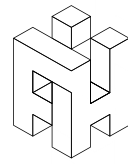

PETAL COMB



PETAL ECLAIR



20FH03S - h 60 mm - prod. 8 pcs
20FH03L - h 80 mm - prod. 8 pcs



20FH06 - h 25 mm - prod. 6 pcs

TEMPLATE

Chocolate Decoration Tool

Grazie a questi strumenti, realizzare **decorazioni in cioccolato** non è mai stato così facile. Perfetti per finire torte e monoporzioni, le **dime in acciaio inox** consentono risultati stupefacenti, anche ai meno esperti.

Thanks to these tools, creating **chocolate decorations** has never been so easy. Perfect for decorating cakes and individual desserts, the **stainless steel templates** allow amazing results, even for the less experienced.



Scopri come creare le decorazioni con i template
Find out how to create decorations with the templates

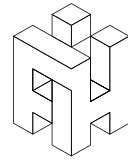

WAVE



DROP



20FH50 - 300 h 55 mm



20FH51 - 300 h 70 mm



ZIGZAG



HEARTBEAT



20FH54 - 300 h 70 mm



20FH53 - 300 h 85 mm

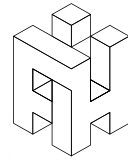

**FRANK
HAASNOOT** for  **Martellato**



FLAME

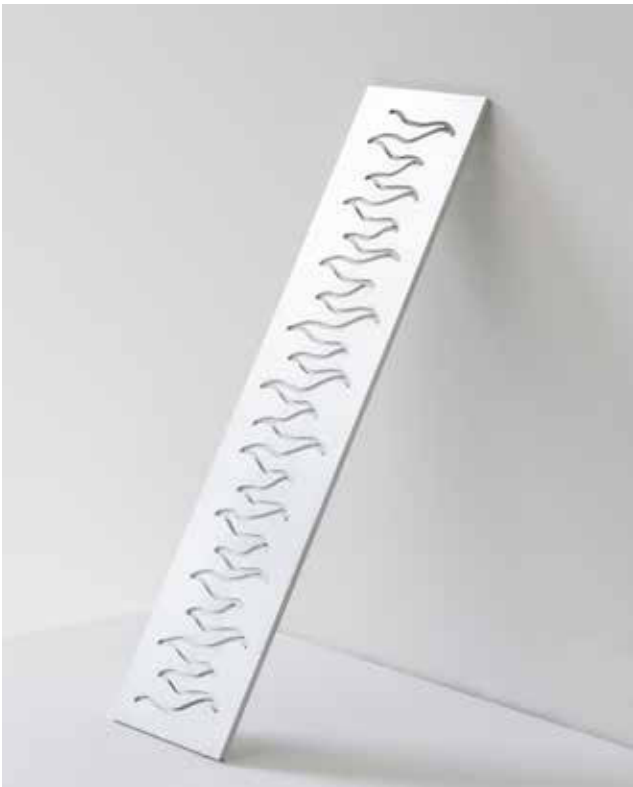

20FH52 - 300 h 80 mm



Frank Haasnoot



STAMP

Chocolate Decoration Tool

Si arricchisce la gamma di strumenti creati da **Frank Haasnoot** per realizzare facilmente decorazioni in cioccolato. Con i nuovi timbri sarà possibile personalizzare le creazioni con messaggi d'auguri o dando identità agli ingredienti utilizzati.

The range of tools created by **Frank Haasnoot** for easily making chocolate decorations has been expanded. With the new stamps, it will be possible to personalise the creations with messages of good wishes or by giving identity to the ingredients used.





HAPPY BIRTHDAY

20FH30S - Ø 3 cm

20FH30L - Ø 6 cm



VANILLA

20FH33L - Ø 6 cm



COCOA

20FH32L - Ø 6 cm



COFFEE

20FH34L - Ø 6 cm

STAMP

Chocolate Decoration Tool



HAPPY VALENTINE

20FH37S - Ø 3 cm
20FH37L - Ø 6 cm



LOVE

20FH31S - Ø 3 cm
20FH31L - Ø 6 cm





HAPPY EASTER

20FH36S - Ø 3 cm

20FH36L - Ø 6 cm



MERRY CHRISTMAS

20FH35L - Ø 6 cm





Circle disk

Polycarbonate Moulds

275x175 mm

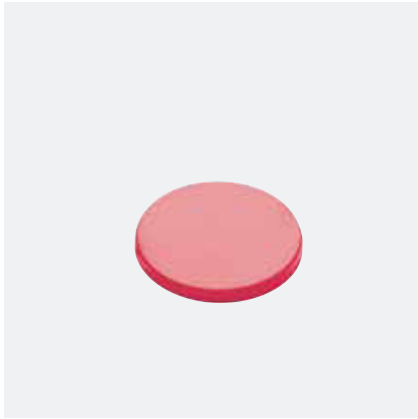

CIRCLE 30

MA1026

Ø 30 h 3 mm
Prod. 24 pcs ~ 2,5 gr



CIRCLE 33

MA1027

Ø 33 h 4 mm
Prod. 24 pcs ~ 4 gr



CIRCLE 40

MA1028

Ø 40 h 4 mm
Prod. 15 pcs ~ 5,5 gr



CIRCLE 75

MA1030

Ø 75 h 5 mm
Prod. 6 pcs ~ 25 gr

DECORATIONS

Decorazioni di grande effetto per donare un tocco di unicità al dessert. Progettati e realizzati con il preciso intento di fornire al pasticciere un valido strumento per produrre raffinate decorazioni di cioccolato.

Wonderful decorations to make your desserts unique.
Designed and produced to give pastry chefs a perfect tool to create fine chocolate decorations.

Polycarbonate Moulds

275x175 mm





20-D001
Prod. 18 pcs - 2/3 gr
63x h21 mm



20-D002
Prod. 18 pcs - 2/3 gr
66x h20 mm



20-D003
Prod. 16 pcs - 2/3 gr
64x h26 mm



20-D004
Prod. 18 pcs - 2/3 gr
63x h23 mm



20-D005
Prod. 18 pcs - 2/3 gr
72x h24 mm



20-D006
Prod. 18 pcs - 2/3 gr
72x h19 mm



20-D007
Prod. 18 pcs - 2/3 gr
66x h21 mm



20-D008
Prod. 18 pcs - 2/3 gr
65x h22 mm



20-D009
Prod. 18 pcs - 2/3 gr
70x h19 mm



20-D010
Prod. 14 pcs - 2/3 gr
50 x h38 mm



20-D011
Prod. 16 pcs - 2/3 gr
62 x h31 mm



20-D012
Prod. 12 pcs - 3/4 gr
50 x h49 mm



20-D013
Prod. 15 pcs - 2/3 gr
47 x h39 mm



20-D014
Prod. 11 pcs - 2/3 gr
Ø 50 mm



20-D020
 Prod. 6+6+6 pcs ~2/3 gr
 71x71 - 51x51 - 31x31 mm



20-D021
 Prod. 6+6+6 pcs ~2/3 gr
 73x72 - 54x51 - 35x30 mm



20-D022
 Prod. 9+9 pcs ~2/3 gr
 68x81 - 39x47 mm



20-D023
 Prod. 6+6+6 pcs ~2/3 gr
 66x79 - 46x58 - 28x36 mm



20-D024
 Prod. 12 pcs ~2/3 gr
 70x38 mm



20-D025
 Prod. 10+10 pcs ~2/3 gr
 73x44 - 50x24 mm



20-D026
 Prod. 10+10 pcs ~2/3 gr
 41x73 - 20x50 mm



20-D027
 Prod. 6/6+6/6 pcs ~2/3 gr
 38x72 - 33x20 mm



LETTERS AND NUMBERS 1 2 3 4 5 6 7 8 9



MA3005

lettere e numeri h30mm
letters and numbers h30mm
Policarbonato - Polycarbonate
Stampo - Mould 275x175mm

FANTASY

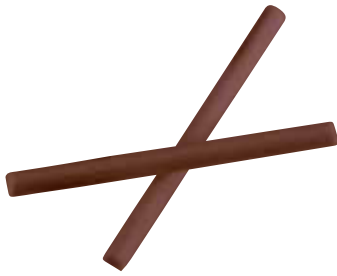

20-D016

Prod. 22 pcs - 3/4 gr
110 x h7 mm

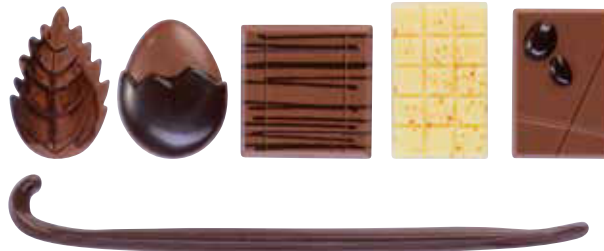

20-D028

22 pcs mix



20-D017

Prod. 8+8 pcs ~2/3 gr
108x17 - 101x18 mm



20-D019

Prod. 13+13 pcs ~2/3 gr
123x4 - 109x5 mm



20-D015

129 x h17 mm - 12 pcs ~12 gr

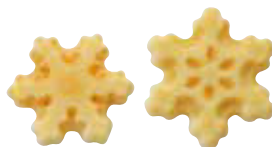

20-D029

14 pcs Ø 30 h 4mm ~1gr
12 pcs Ø 40 h 4mm ~2gr



Chablon project

Nasce un progetto completo di **decorazioni** per monoporzioni, snack e torte semplici e veloci da realizzare, per uniche ed esclusive creazioni.

Tappeti in flessibile silicone alimentare, con **forme perfette e precise**, pensati per il cioccolato ma adatti anche ad isomalto, caramello, pastigliaggio ed altri impasti che consentiranno di personalizzare la produzione facilmente.



FLOWERS CHASIL34

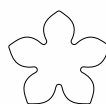

8 pcs 52x49 mm 8 pcs 42x40 mm 12 pcs 33x31 mm

BUTTERFLIES CHASIL31



8 pcs 60x44 mm 8 pcs 54x40 mm 12 pcs 46x34 mm



A complete project of **decorations** for individual desserts, snacks and cakes, easy and quick to be used for unique and exclusive creations.

The flexible food silicone mats with **perfect and precise shapes** are designed for chocolate, but work also for isomalt, caramel, pastillage and other doughs in order to easily personalize the production.



Silicone
Tappeto/Mat 390x290 mm
Spessore/Thickness 1,5 mm



HEARTS CHASIL33



8 pcs 45x43 mm 8 pcs 40x39 mm 12 pcs 35x34 mm



SPOT CHASIL32

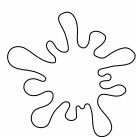

16 pcs 60x63 mm

Chablon project



FLOWERS
CHASIL34
52x49 mm - 8 pcs
42x40 mm - 8 pcs
33x31 mm - 12 pcs



BUTTERFLIES
CHASIL31
60x44 mm - 8 pcs
54x40 mm - 8 pcs
46x34 mm - 12 pcs



SQUARE
CHASIL23
25x25 mm - 63 pcs

SQUARE
CHASIL24
37,5x37,5 mm - 30 pcs

SQUARE
CHASIL25
60x60 mm - 12 pcs



SPOT
CHASIL32
60x63 mm - 16 pcs



ROUND
CHASIL 16
Ø 26 mm - 48 pcs

ROUND
CHASIL 17
Ø 36 mm - 36 pcs

ROUND
CHASIL 18
Ø 42 mm - 30 pcs

ROUND
CHASIL21
Ø 20 mm - 99 pcs

ROUND
CHASIL26
Ø 62,5 mm - 12 pcs



OBLONG
CHASIL20
132x32 mm - 10 pcs

OBLONG
CHASIL27
125x25 mm - 18 pcs

OBLONG
CHASIL28
60x18 mm - 36 pcs



RECTANGULAR
CHASIL19
32x120 mm - 12 pcs



STAR
CHASIL29
Ø 26 mm - 60 pcs

STAR
CHASIL30
Ø 34 mm - 42 pcs



HEARTS
CHASIL33
45x43 mm - 8 pcs
40x39 mm - 8 pcs
35x34 mm - 12 pcs



DROP
CHASIL 1
35x25 mm
60 pcs



LEAF
CHASIL 2
35x33 mm
48 pcs



HEART
CHASIL 3
35x25 mm
48 pcs



PUZZLE
CHASIL 5
50x78 mm
18 pcs



FLOWER
CHASIL 8
55x50 mm
25 pcs



FANTASY 10
CHASIL 10
97x30 mm
18 pcs



LEAF
CHASIL22
75x33 mm
25 pcs

COFFEE TIME

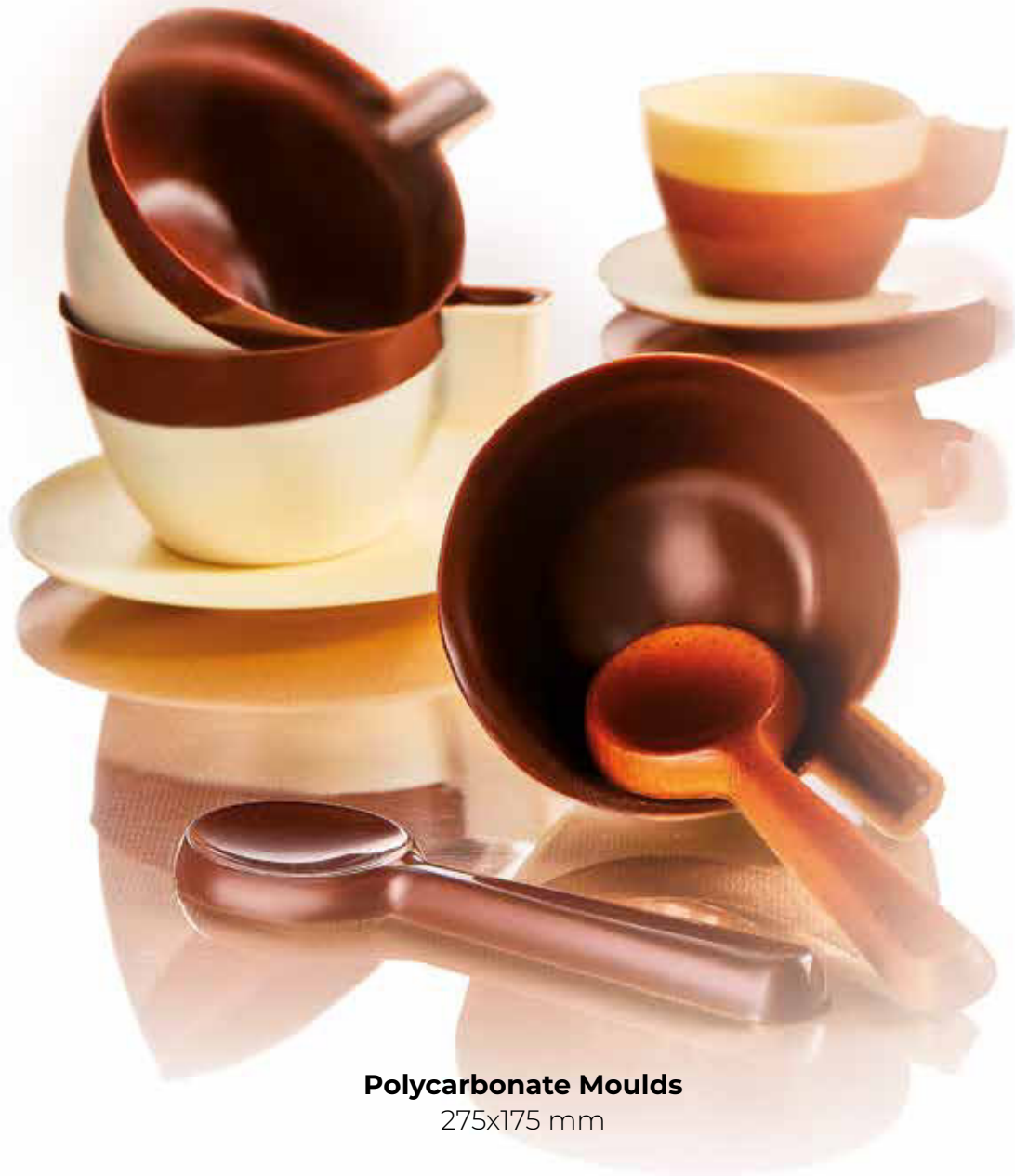

Polycarbonate Moulds
275x175 mm

CUP

Tazzine grandi
MA1951
55x69 h 34mm
Prod. 7 pcs ~20 gr

PLATE

Piattini grandi
MA1952
Ø 81 h 8mm
Prod. 3 pcs ~10 gr

SPOON

Cucchiari
MA3006
92x26 h 7mm ~6 gr
Prod. 13 pcs

SMALL CUP

Tazzine piccole
MA1953
47x59 h 30mm
Prod. 7 pcs ~17 gr

SMALL PLATE

Piattini piccoli
MA1954
Ø 67 h 6,5mm
Prod. 5 pcs ~9 gr



LET'S PLAY



Chess Game

20CG01

Thermoformed plastic
Ø 25/35 h 40/80 mm
4 Moulds - Prod. 20 mix pcs ~11/36 gr



Playing Cards

20PC01

Thermoformed plastic
55x90 h 5 mm
4 Moulds - Prod. 16 pcs ~55gr



Chocolate

PER LUI FOR HIM



Working Tools

20WT01

Thermoformed plastic
190x50 / 115x20 mm
4 Moulds - Prod. 20 mix pcs ~20/50 gr

FASHION & STYLE



Mr Chocolate
200B01

Thermoformed plastic
moustache: 117x30 h15 mm
glasses: 140x50 h 10 mm
1+1 Moulds
Prod. 4+4 pcs ~22gr



Mr Cigar
20SI01

Thermoformed plastic
125 - Ø 20 mm
2 Moulds
Prod. 8 pcs ~40gr

PER LUI FOR HIM

Soccer Ball
MAC323S
Thermoformed plastic
Ø 120 mm
1 Mould



Football Boot
MAC322S
Thermoformed plastic
195x60 h 80 mm
1 Mould



Mr. Papillon
20PP01
Thermoformed plastic
120x52 h13mm
4 Moulds - Prod. 12 pcs ~55gr

PER LEI FOR HER



My Sweet Bag
20BA01
Thermoformed plastic
119x52 h126
2 Moulds - Prod. 2 pcs ~190gr



Eau de Chocolat
20PA01
Thermoformed plastic
60x31 h92mm
4 Moulds - Prod. 4 pcs ~90gr



FASHION & STYLE



Lady shoe BIG
MAC326S
Thermoformed plastic
220x85 h165 mm
1 Mould
Prod. 1 pcs ~375 gr

Lady shoe SMALL
MAC330
Polycarbonate mould
with magnets
160x70 h120 mm
Prod. 1 pcs ~120 gr



CHOCO MACARON

Stampo in silicone per realizzare splendide praline a forma di macaron.
Silicone mould to create wonderful macaron pralines.



Gusci macaron e vassoio
Macarons shells and tray

30SMT01

prod. 24 gusci / shells
Soggetti/Subjects: Ø 33 h12mm
Vassoio - Tray: 320x195mm
Silicone mould



OLD STYLE

Stampi 3D in silicone per realizzare realistici soggetti in cioccolato o isomalto.
3D silicone moulds to create realistic figures in chocolate or isomalt.

Silicone
Idea
sweet creation



Scooter vintage
Vintage scooter
30SM071
80x50 h75mm

CHOCO LIGHT

Stampi termoformati leggeri ed economici per realizzare soggetti e decorazioni.
Light and economical thermoformed moulds to create subjects and decorations.

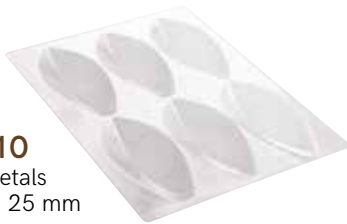

20-1010
Prod. 6 petals
105x50 h 25 mm

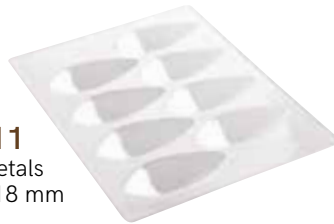

20-1011
Prod. 8 petals
80x35 h 18 mm

LOTUS FLOWER

Kit composto da 1 stampo semisfera e 4 stampi petalo.
Kit made up of 1 semisphere mould and 4 petal moulds.



90-13064



2 pcs
Ø 50 h5



2 pcs
Ø 40 h5



2 pcs
Ø 32 h5



2 pcs
55x50 h5



1 pcs
70x40 h5



1 pcs
80x45 h5



1 pcs
55x30 h5



90-13040
12 pcs - 35x60 h8



90-13179



2 pcs
55x70 h5



2 pcs
70x88 h5



1 pcs
75x95 h8



90-12816



2 pcs - 50x20
h8



2 pcs - 27x27
h10



2 pcs - 40x35
h10



2 pcs - 53x27
h8



2 pcs - Ø 42 h8



2 pcs - 52x27
h8



2 pcs - 35x40
h8



90-P9645

10 pcs
80x35 h3mm



90-14243

1 pcs
45x40 h5mm



90-P9661

13 pcs
50x25 h3mm



90-P9662

14 pcs
50x25 h3mm



90-1000

1 pcs
210x64 mm



90-15303

12 pcs
42x19 h6mm



DIAMOND

Christmas



SANTA

MA3013

68 x 61 h 130 mm ~ 60 gr
prod. 2 pcs

Chocolate

La tradizione si trasforma in modernità nei due nuovi stampi in policarbonato per soggetti natalizi. L'albero e il babbo, simboli del Natale in versione diamantata, si prestano a nuove interpretazioni.

Tradition turns into modernity in the two new polycarbonate moulds designed for Christmas subjects. The tree and the Santa Claus, symbols of Christmas in a diamond version, lend themselves to new interpretations.

Polycarbonate Moulds

275x175 mm



TREE

MA3012

Ø 104 h 180 mm ~ 78 gr
prod.1 pcs

CHOCO

Tradition



TRESMAS

MA3009

Ø 75 h120mm ~ 45 gr

prod. 2 pcs

Due iconici simboli del Natale si fanno cioccolato con i nuovi stampi in policarbonato. Gli intramontabili Babbo e Albero di Natale, che uniscono nel design tradizione e modernità, non possono mancare all'interno delle vetrine di pasticceri e cioccolatieri.

Two iconic symbols of Christmas become chocolate with the new polycarbonate moulds. The timeless Santa Claus and Christmas Tree, which combine tradition and modernity in their design, cannot be missed inside the display windows of pastry chefs and chocolatiers.

Polycarbonate Moulds

275x175 mm



SANTA

MA3008

Ø 70 h120mm ~ 55 gr

prod. 2 pcs

XMAS

Bottles

Convivialità e celebrazione sono le caratteristiche del Natale. Martellato, ispirandosi a queste, propone due nuovi stampi in policarbonato per la realizzazione di eleganti bottiglie in cioccolato, formato tridimensionale o pralina.

Conviviality and celebration are the characteristics of Christmas. Martellato, inspired by these, presents two new polycarbonate moulds for the creation of elegant chocolate bottles, three-dimensional or praline shape.

Polycarbonate Moulds 275x175 mm

SMALL BOTTLE

MA3011

PRALINE

60,2x20,6 h 15,8 mm - 12 gr
prod. 18 pcs



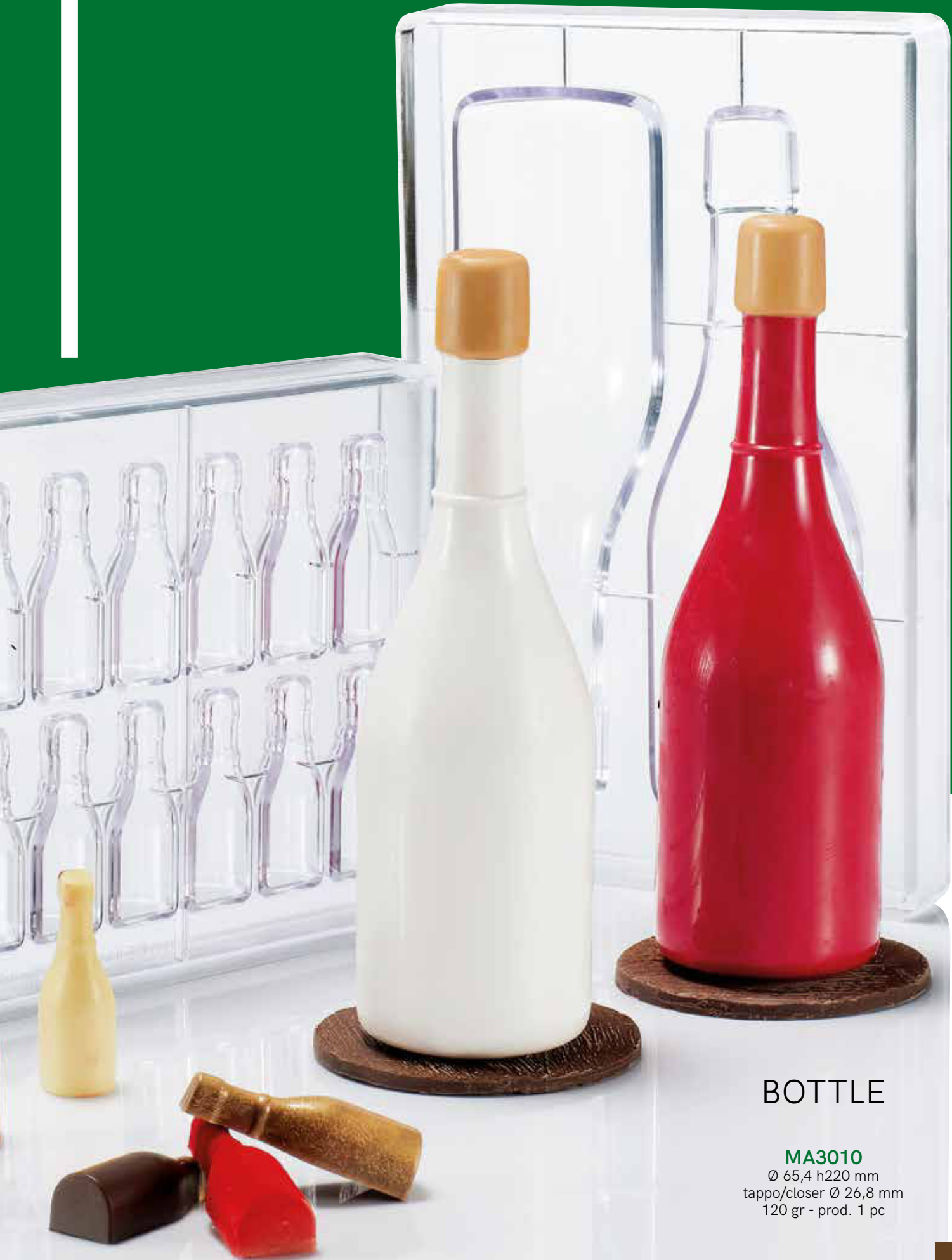

BOTTLE

MA3010

Ø 65,4 h220 mm
tappo/closer Ø 26,8 mm
120 gr - prod. 1 pc

XMAS

Trees

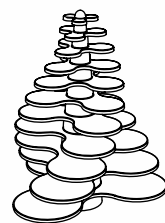
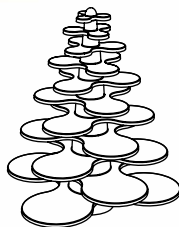
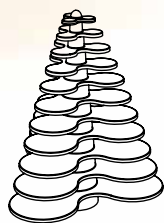

Modular Trees

2OCT01

Ø 150 h 180mm ~290 gr
4 Moulds - prod: 2 trees

Stampi cono in plastica termoformata per realizzare alberi o pièce in cioccolato.

Thermoformed plastic moulds to make Christmas trees or chocolate pièce.



Big Tree
20C002
Ø 123 h 205mm ~300gr
Prod: 2 pcs

Small Tree
20C001
Ø 83 h 140mm ~140gr
Prod: 4 pcs

XMAS

Trees

Gli stampi in plastica termoformata della linea natalizia di Martellato permettono al pasticcere di giocare con rivisitate forme di albero di Natale, scatenando la fantasia per trovare la perfetta combinazione di colori.

The thermoformed plastic moulds of the Martellato Christmas line allow the pastry chef to play with revisited Christmas tree shapes, unleashing the imagination to find the perfect combination of colours.



Thermoformed Plastic



20A3D01

Ø 112 h180 mm ~170gr
4 Moulds - Prod. 2 pcs



20A3D02

Ø 95 h120 mm ~100gr
4 Moulds - Prod. 4 pcs





SWEET

Christmas

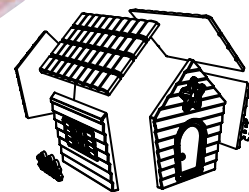
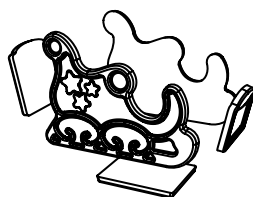

Christmas Sledge
20SL01

Thermoformed plastic
140x70 h 100mm ~140 gr
2 Moulds - prod: 2 pcs

Sweet Home
20HO01

Thermoformed plastic
108x116 h 118mm ~280 gr
4 Moulds - prod: 2 pcs

Iconici soggetti 3D che rappresentano una
golosa idea regalo da donare in occasione
delle feste a parenti ed amici.

Iconic 3D subjects that represent a delicious
gift idea to donate to relatives and friends
during the holidays.



Chocolate Gift
20PRO1

Thermoformed plastic
80x80 h 69mm ~80 gr
2 Moulds - prod: 2 pcs



Chocolate gift
(Praline)

MA1991

Polycarbonate mould
26x26 h 20mm ~11gr
prod: 28 pcs

PRALINES

Polycarbonate Moulds

275x175 mm



Chocolate gift

MA1991

Polycarbonate mould
26x26 h 20mm ~11gr
prod: 28 pcs



Pandoro

MA1990

Polycarbonate mould
Ø 30 h 25mm ~10gr
prod: 24 pcs



Christmas Baubles

MA1974

30x26 h 16,5mm ~ 7 gr
prod: 5X6 pcs



Stars

MA1984

40x42 h 16mm ~ 10 gr
prod: 5x6 pcs



Christmas Trees

MA1975

31X22 h 22mm ~ 7 gr
prod: 5X5 pcs

Xmas PUZZLE

Thermoformed Plastic Moulds

Pratico kit in plastica termoformata ideale per la creazione veloce di 3 differenti soggetti 2D tematici.

Practical thermoformed plastic kit ideal for the quick creation of 3 different 2D thematic subjects.



20BC100

Conf. 3 models

1 95x9 h 147mm ~80 gr

2 103x9 h 150mm ~80 gr

3 100x9 h 123mm ~80 gr

SEMISPHERES & Decorations

Polycarbonate Moulds

275x175 mm



MA5000

24 half spheres
Ø 30mm

MA5003

45 half spheres
Ø 20mm

MA5004

15 half spheres
Ø 40mm

MA5001

8 half spheres
Ø 50mm

MA5005

6 half spheres
Ø 60mm

MA5002

2 half spheres
Ø 100mm

MA5007

28 half spheres
Ø 25mm

MA5008

15 half spheres
Ø 35mm

MA5009

12 half spheres
Ø 45mm

MA5010

6 half spheres
Ø 55mm

MA5006

4 half spheres
Ø 80mm

Thermoformed Moulds



Kit 6 Stampi - Moulds

20SF001

Ø 100 mm - prod 1 pc
Ø 130 mm - prod 1 pc
Ø 140 mm - prod 1 pc
Ø 150 mm - prod 1 pc
Ø 175 mm - prod 1 pc
Ø 200 mm - prod 1 pc

Kit 4 Stampi - Moulds

20SF002

Ø 50 mm - prod 6 pcs
Ø 65 mm - prod 4 pcs
Ø 75 mm - prod 4 pcs
Ø 90 mm - prod 2 pcs

Fiocchi di Neve Snowflakes



20-D029

Polycarbonate mould
14 pcs Ø 30 h 4mm ~1gr
12 pcs Ø 40 h 4mm ~2gr

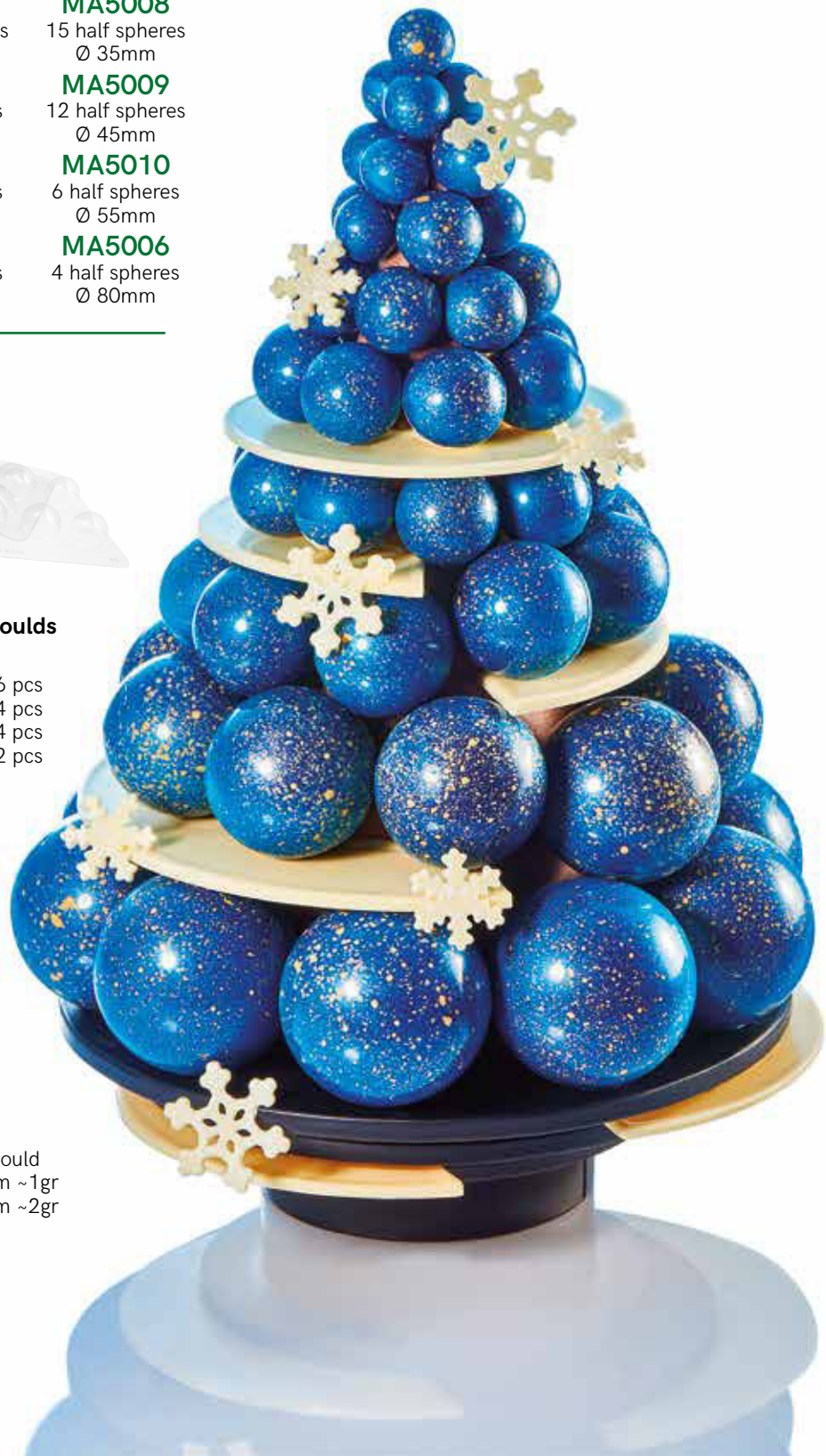

XMAS

Baubles

Creazioni in cioccolato
che saranno doni
desiderati ed apprezzati.

Chocolate creations
will be desired
and appreciated gifts.



20SF003
Ø 60mm ~40 gr



20SF004
Ø 60mm ~40 gr



20SF005
Ø 60mm ~40 gr



20SF006
Ø 60mm ~40 gr



20SF007
Ø 60mm ~39 gr



20SF008
62x69mm ~26 gr



Thermoformed Plastic Moulds
Prod. 6 half baubles each

3D

Xmas

Stampi in plastica rigida termoformata completi di molle per realizzare facilmente splenditi soggetti tematici tridimensionale.

Thermoformed plastic moulds complete with springs to easily create hollow chocolate figures.



Tender bear
MAC409S
67x54 h105mm ~90gr



Surprise bear
MAC408S
63x54 h101mm ~90gr



Princess
MAC411S
1 pc 72x72 h125mm



Toy Soldier
MAC407S
1 pc 40x34 h150mm



Pandoro - Traditional Cake
MAC412S
Ø 92 h 85mm ~80 gr



Panettone
Traditional Cake
MAC413S
Ø 77 h 85mm ~80 gr

3D Xmas

Polycarbonate Moulds:
275x175 mm

Stampi ad alta produttività
in polycarbonato con
calamite per realizzare
in modo facile e preciso
soggetti natalizi.

High productivity
polycarbonate moulds
with magnets to easily and
precisely create Christmas
figures.



Reindeer
20-C1001
Prod. 4 pcs
43x43 h120 mm ~65 gr



Reindeer
20-C1002
Prod. 4 pcs
46x45 h100 mm ~68 gr



Santa & Snowman
20-C1010
Prod. 2+2 pcs
Santa Claus: Ø 46 h79 mm
Snowman: 42x46 h72 mm



Tree
20-C1000
Prod. 5 pcs
Ø 58 h 100 mm ~100 gr



LOLLIPOP

Mania

Gli stampi in plastica termoformata e silicone permettono al pasticcere o al cioccolatiere di creare degli snack in cioccolata, ideali come piccolo gesto d'affetto per i più piccoli.

The thermoformed plastic and silicone moulds allow the pastry chef or chocolatier to create chocolate snacks, ideal as a small gesture of kindness for the little ones.

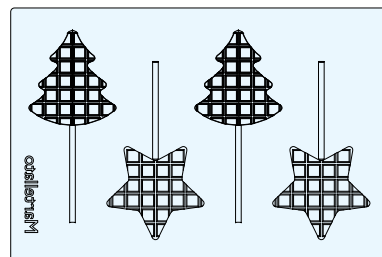

Chocolate lollipop moulds 20L005

Thermoformed plastic
Albero - Tree: 70x76 h9 mm ~34 gr
Stella - Star: 77x74 h9 mm ~31 gr
Prod. 8 pcs



Chocolate lollipop moulds

30SML002

Silicone mould

Prod. 5 pcs

Tray included: 395x143mm



70x80mm

75x85mm

70x85mm

80x80mm

60x85mm

Chocolate lollipop moulds

20-C024

Rigid plastic mould

Prod. 6 pcs

60x70 mm ~30gr



CHOCO

3D

Stampi in plastica rigida termoformata, completi di molle, per realizzare facilmente splendidi soggetti tematici tridimensionali.

Thermoformed rigid plastic moulds, complete with springs, to easily create shiny three-dimensional thematic subjects.

**Santa Claus
with fawn**
MAC140S
h180mm



**Santa Claus with
teddy bear**
MAC170S
h168mm



Angel with Candle
MAC000S
h80mm
(3 figures)

MAC001S
h125mm
(2 figures)



Mr Penguin
MAC300S
h230mm



Santa Claus bear
MAC281S
h180mm



Nativity
MAC410S
 175x50 h115 mm



Big Boot
MAC421S
 h135mm



Happy Snowman
MAC310S
 h100mm
 (2 figures)



Snowman
MAC320S
 h114mm
 (3 figures)

MAC321S
 h150mm

CHOCO

Light

Stampi termoformati per realizzare soggetti e decorazioni di cioccolato

Thermoformed mould for chocolate figures and decorations.



90-4108



4 pcs
 Ø 30 h8

4 pcs
 35x25 h8

4 pcs
 Ø 35 h8

4 pcs
 35x26 h8



90-4109



4 pcs
 50x30 h6

4 pcs
 48x25 h6

4 pcs
 48x30 h6

4 pcs
 45x30 h6

Easter EGGS



Sono in polycarbonato di alta qualità gli stampi per Uova in cioccolato proposti per la nuova Pasqua. Che sia diamantato o decorato da nastri, il risultato è un prodotto di grande effetto realizzabile facilmente.

Polycarbonate Moulds

275x175 mm

DIAMOND

20U502

Ø 99 h 150 mm ~ 210 gr

Prod. 1 uovo/egg

BASE

20U503

68 x 68 h 5,5 mm ~ 16 gr

Prod. 6 pcs





The moulds for chocolate eggs of this Easter are made of high quality polycarbonate. Whether with diamond or ribbons decorations, the result is a product of great effect made easily.

BOND

20U504

Ø 101 h 150 mm ~ 210 gr

Prod. 1 uovo/egg

Easter EGGS



Polycarbonate Moulds

275x175 mm

PUZZLE e **DRIP** sono due stampi per realizzare uova di cioccolato con **design appositamente studiato** e **qualità del materiale**, che consentono la creazione di soggetti, che risultano già decorati. Un tocco di colore potrà dare la personalizzazione desiderata.

PUZZLE

20U500

Ø 105 h 150 mm ~ 210 gr
prod. 1 uovo/egg



PUZZLE and **DRIP** are two chocolate egg moulds with **specially developed design** and **quality of the material**, that allow the creation of objects, that will be already decorated. A simple touch of colour can be used to add the desired customization.

DRIP

20U501

Ø 100 h 150 mm ~ 210 gr
prod. 1 uovo/egg

Prestige Easter

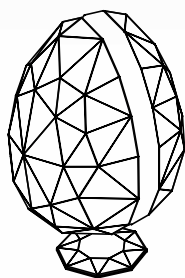

DIAMOND

20U3D07
Thermoformed plastic
Prod. 2 uova/eggs
Ø 120 h 185 mm
~280 gr



GLOBE

20U3D08
Thermoformed plastic
Prod. 2 uova/eggs
Ø 125 h 185 mm
~280 gr



SAVE THE PLANET WITH US

Scegliendo questo prodotto collaborerai con noi alla salvaguardia del nostro pianeta. Martellato da tempo collabora attivamente sostenendo progetti concreti, per questo ha deciso che parte del ricavato della vendita di questo prodotto sarà donato all'onlus **Save the planet**.

Choose this product and you will help us in preserving our planet. Martellato actively collaborates in supporting sustainable projects, that's why part of the proceeds from the sale of this product will be donated to the non-profit organization **Save the planet**.

More info: savetheplanet.green - martellato.com

save the planet

with us



**YOU BUY,
WE DONATE!**

Prestige

Easter

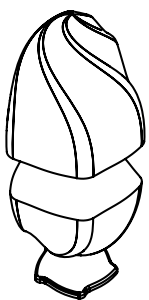

WAVE

20U3D02
Thermoformed plastic

Prod. 2 uova/eggs
Ø 115 h 185 mm
~320 gr

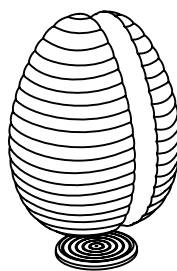

HONEY

20U3D04
Thermoformed plastic

Prod. 2 uova/eggs
Ø 122 h 185 mm
~270 gr

Chocolate

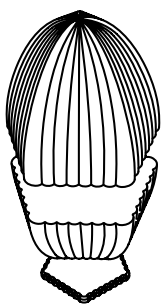

PENTA

20U3D03
Thermoformed plastic
Prod. 2 uova/eggs
Ø 120 h 185 mm
~300 gr



CURVY

20U3D05
Thermoformed plastic
Prod. 2 uova/eggs
Ø 115 h 185 mm
~310 gr

Prestige Easter

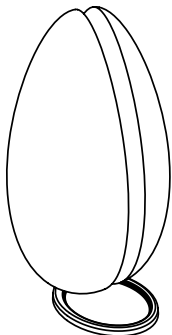

STRETCH

20U3D01
Thermoformed plastic
Prod. 2 uova/eggs
Ø 110 h 220 mm
~230 gr

Chocolate

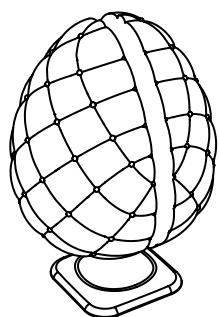

CAPITONNÉ

20U3D06

Thermoformed plastic

Prod. 2 uova/eggs

Ø 115 h 155 mm

~230 gr

PUZZLE EGGS



20UB100

Thermoformed plastic

Pack 3 models

1 107x82 h 158mm ~160 gr

2 110x58 h 165mm ~160 gr

3 104x52 h 150mm ~140 gr

Origami Easter

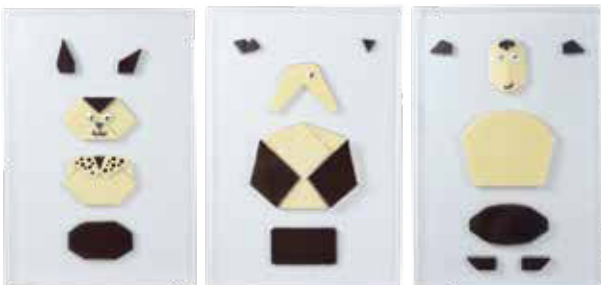

20OR001 Thermoformed plastic

Pack 3 models
Chick 113x42 h132 mm ~100 gr
Sheep 100x45 h100 mm ~90 gr
Bunny 76x42 h142 mm ~60 gr

CHOCO

3D

Stampi in plastica termoformata
per soggetti di cioccolato con corpo cavo.
Thermoformed plastic mould
hollow for chocolate figures.



DUCK

MAC611S
70x70 h120mm
~110 gr

LITTLE BUNNY

MAC614S
Ø 60 h140mm
~85 gr

CHICKEN

MAC612S
70x70 h130mm
~110 gr

BUNNY

MAC613S
Ø 80 h120mm
~110 gr



MS COCODÉ

MAC615S
108x75 h120 mm
~90 gr

MR. BUNNY

MAC616S
90x60 h152 mm
~100 gr

CHOCO

3D



SHEEP

MAC603S
140x120 h190mm ~310 gr

CHICK

MAC602S
160x120 h210mm ~460 gr

RABBIT

MAC604S
120x120 h220mm ~480 gr

Stampi in plastica rigida termoformata con molle per realizzare soggetti tridimensionali.
Thermoformed plastic mould with springs to easily realize hollow chocolate figures.



NICE CHICKEN

MAC800S - h160 mm (2 figures)
MAC801S - h205 mm



SMALL CHICKEN

MAC822S - h110 mm
MAC823S - h160 mm



BABY CHICK

MAC870S - h110 mm
(3 figures)



BABY GOOSE

MAC880S - h145 mm



3 IN A BASKET

MAC610S - h170 mm



BUNNY

MAC661S - h140 mm



BABY BUNNY

MAC620S - h180 mm



HUG IN EGG

MAC720S - h170 mm ((2 figures))



BUNNY IN LOVE

MAC630S - h235 mm

CHOCO

3D

Stampi in plastica rigida termoformata con molle per realizzare soggetti tridimensionali.
Thermoformed plastic mould with springs to easily realize hollow chocolate figures.



SMALL BELL

MAC950S - h110 mm



BIG BELL

MAC952S - h140 mm

CHOCO

Light

Stampi in plastica termoformata per realizzare soggetti e decorazioni di cioccolato.
Thermoformed plastic moulds to create chocolate figures and decorations.



90-2102



3 pcs 4 pcs 4 pcs 3 pcs
 43x40 h12 40x35 h11 40x35 h17 48x35 h8



90-2316

79x58h12 mm
 2 pcs



90-2346

150x64h25 mm
 1 pcs





Polycarbonate Moulds
275x175 mm

Stampi ad alta produttività in policarbonato con calamite
per realizzare in modo facile e preciso soggetti pasquali.

High productivity polycarbonate moulds with magnets
to easily and precisely create Easter objects.

ROOSTER

20-C1955
100x160 h126 mm ~115 gr
Prod.2 pcs

HEN

20-C1956
94x108 h106 mm ~75 gr
Prod.4 pcs

CHICK

20-C1957
65x84 h80 mm ~45 gr
Prod.6 pcs

Light Half
EGGS

Stampi in plastica termoformata
Thermoformed plastic moulds



SMOOTH HALF EGG



90-2026

25x35h12 mm
18 pcs



90-2008

36x23h12 mm
18 pcs



90-2010

40x31h17 mm
14 pcs



SM1000

80x60h25 mm
4 pcs



SM2000

110x80h40 mm
2 pcs



SM3000

140x100h50 mm
2pcs



SM2300

112x83h44 mm
1 pc x 2 moulds



SM4000

220x160h85 mm
1 pcs

SM2500

125x94h44 mm
2pcs

SM3500

154x110h55 mm
2pcs

CRACK HALF EGG



90-2009

39x25 h13 mm
14 pcs



90-2353

64x44 h26 mm
6 pcs



90-2354

83x54 h24 mm
4 pcs -



2 moulds

90-2355

96x70 h40 mm
2 pcs



2 moulds

90-2356

140x100 h49 mm
1 pcs



Sectioned EGGS



20-U1010
h110 mm ~100 gr
Thermoformed mould



20-U1011
h180 mm ~250 gr
Thermoformed mould

SMOOTH HALF EGG

Stampo in resistente **plastica termoformata** per la realizzazione di uova di cioccolato.
Resistant **thermoformed plastic** mould to realize chocolate eggs.

~Kg	Misure mm	Code
0,5 - 1	250x170	SUT25X17
0,8 - 1,2	280x185	SUT28X18
1,5 - 2	325x240	SUT34X25
2 - 2,5	390x265	SUT40X27
2,5 - 3,5	435x310	SUT45X32
4 - 6	520x350	SUT54X36
6 - 8	620x420	SUT64X43
8 - 10	740x490	SUT75X50



EGGS HOLDERS



21VA085
Ø 85 h70 mm
Conf. 58 pcs
Plastic



21VA102
Ø 102 h88 mm
Conf. 40 pcs
Plastic



Per realizzare supporti di cioccolato
To create chocolate holders

20-CU001
Set 3 thermoformed moulds
36,5x36,5 h9 mm - 12 pcs
40,5x40,5 h12 mm - 9 pcs
52,7x52,7 h12 mm - 6 pcs

ANIMATED EGGS

Kit stampi componenti in **plastica termoformata** per realizzare soggetti 3D
Thermoformed plastic components mould kit to realize 3D objects

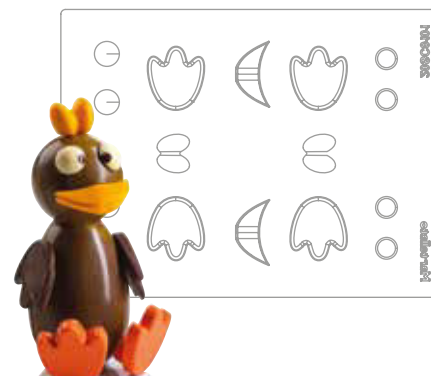
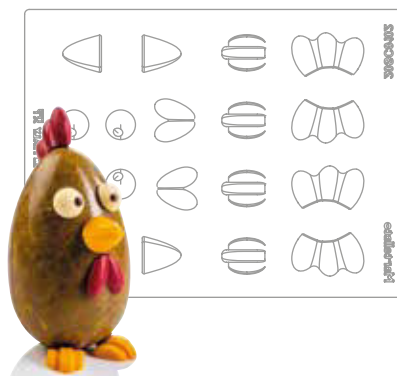

20SC01
Pack 3 pcs for different figures/3 pezzi per soggetti differenti
Non inclusi uova e sfere per corpo/Eggs and sphere for body not included

Easter

EGGS



Created by
Maurizio Frau

Chocolate

Stampi in policarbonato ad alta produttività. La qualità del materiale utilizzato consente di realizzare uova perfettamente lucide e lisce adatta a qualsiasi tipo di decorazione.

High productivity polycarbonate moulds. The quality of the material allow to create shiny and smooth eggs suitable for any type of decoration.

Polycarbonate Moulds

275x175 mm

7GR

20U032N

22x32 mm
prod. 32 metà/half

25GR

20U064N

44x64 mm
prod. 10 metà/half

70GR

20U105N

72x105 mm
prod. 4 metà/half

150GR

20U130N

90x130 mm
prod. 2 metà/half

230GR

20U150N

104x150 mm
prod. 2 metà/half

260GR

20U175N

121x175 mm
prod. 1 metà/half

380GR

20U204N

141x204 mm
prod. 1 metà/half

430GR

20U227N

157x227 mm
prod. 1 metà/half

500GR

20U258

258x175 mm
prod. 1 metà/half

850GR

20U320

320x210 mm
prod. 1 metà/half

Polycarbonate Mould

200x365 h22 mm

Polycarbonate Mould

275x365 h22 mm



Valentine's Day

Polycarbonate Moulds
275x175 mm



Big heart

MA1996

6 pcs 75x70 h 22mm



Heart

MA1995

12 pcs - 45x42 h 16mm



MA1993

33x33 h 15mm
24 pcs ~10gr



MA1513

34x33 h11mm
28 pcs ~7 gr



MA1526

30,5x28 h16,5mm
35 pcs ~8 gr



MA4012

43x26 h 16 mm
20 pcs ~ 11gr



MA1613

40x42 h15mm
15 pcs ~9 gr



MA1962

31x27 h14mm
30 pcs ~8 gr





**Lollipop
20L004**

Thermoformed plastic
68x65 h9 mm ~34 gr
Prod. 8 pcs

Gli stampi in plastica termoformata e silicone permettono al pasticcere o al cioccolatiere di creare degli snack in cioccolata, ideali come piccolo gesto d'amore.

The thermoformed plastic and silicone moulds allow the pastry chef or chocolatier to create chocolate snacks, ideal as a small gesture of love.



30SML003

Silicone mould
Tray included: 395x143mm



**Cupido
Cupid**
65x80mm



**Innamorati
Loving couple**
73x80mm



**Bambina
Girl**
65x85mm



**Innamorato
Boy in love**
60x85mm



**Innamorata
Girl in love**
70x80mm

CHOCO

Light

Stampi termoformati per realizzare soggetti e decorazioni.
Thermoformed mould for figures and decorations.



90-1001

Ø 23 h9
18 pcs



90-1004

Ø 33 h9
18 pcs



90-1026

52x42 h12
8 pcs



90-1212

152x78 h8
3 pcs

HALLOWEEN

Little Pumpkin (Praline)

MA1992

Polycarbonate mould
34x31 h 15mm ~9+9gr
Prod. 12+12 pcs



Black cat

MAC405S

78x56 h140 mm
Thermoformed plastic



Mr Pumpkin

MAC406S

95x90 h110 mm
Thermoformed plastic



Big 3D Pumpkin

MAC325S

140x140 h150 mm
Thermoformed plastic

Big 3D Pumpkin

MAC324S

52x54 h 132mm ~140gr
Thermoformed plastic





Skull (Praline)

MA1017

Polycarbonate mould
37 x 28 h 18 mm
Prod. 20 pcs ~ 10 gr



Pumpkin & Skull Lollipops

20L006

Thermoformed plastic
Prod. 8 pcs

Zucca - Pumpkin:
69x70 h9 mm ~33gr - 4 pcs
Teschio - Skull:
53x70 h9 mm ~32gr - 4 pcs

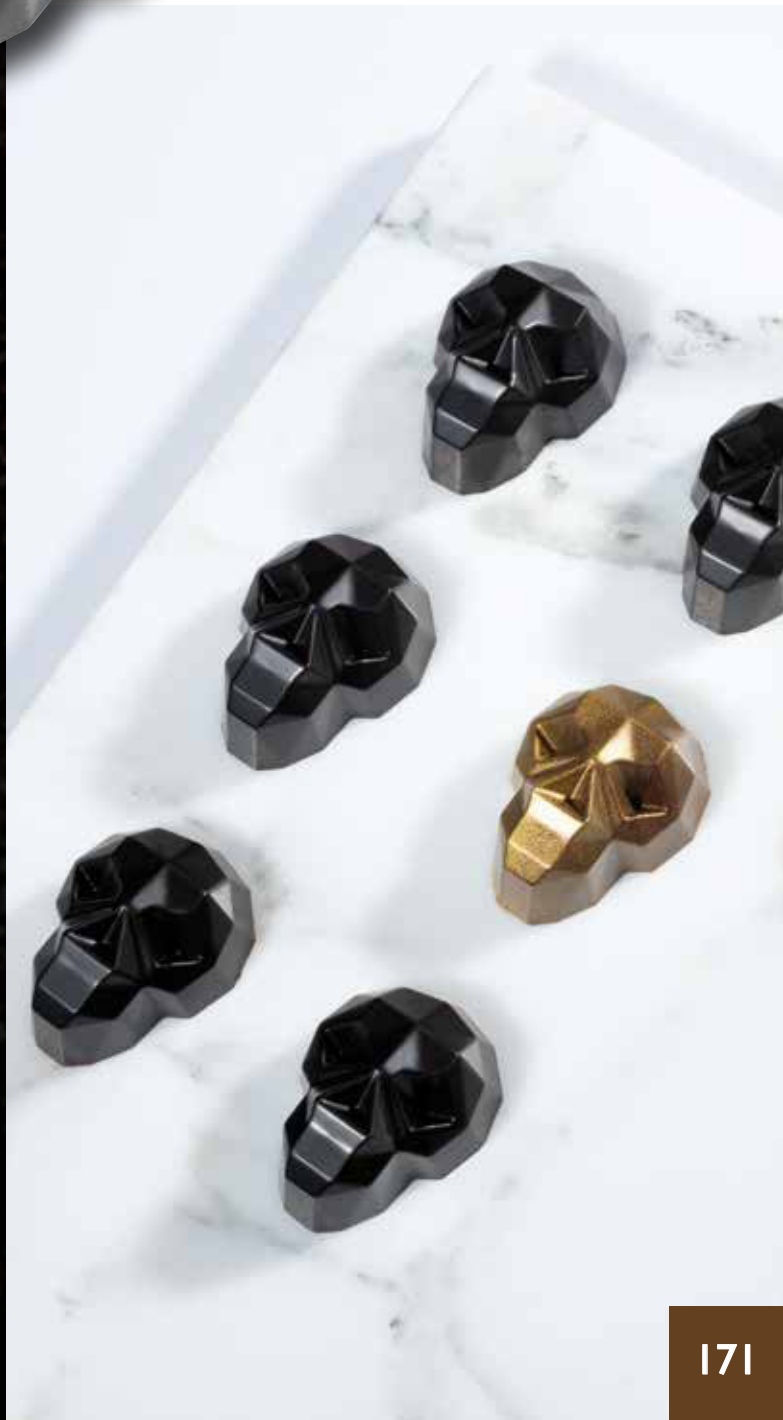

Wedding Time

Tappeti e stampi 3D in silicone per realizzare topper e piece in **cioccolato** o **isomalto** che serviranno a decorare wedding cake o altre creazioni.

Mats and 3D silicone moulds to prepare **chocolate** or **isomalt** toppers and pieces that will be used to decorate wedding cakes or other creations.





Wedding Mat 2
30SMTP02
210x85 h 250mm
Spessore - Thickness: 9mm
Tappeto - Mat: 300x400mm



Wedding Mat 3
30SMTP03
250x85 h285 mm
Spessore - Thickness: 9mm
Tappeto - Mat: 300x400mm



Wedding Mat 1
30SMTP01
260x85 h 310mm
Spessore - Thickness: 9mm
Tappeto - Mat: 300x400mm
vassoio di sostegno in plastica bianca
white plastic support tray

Silicone
Idea
sweet creation

New Born

Tappeti e stampi 3D in silicone per realizzare topper e piece in **cioccolato** o **isomalto** che serviranno a decorare torte o creare originali bomboniere.

Mats and 3D silicone moulds to prepare **chocolate** or **isomalt** toppers and pieces ideal to decorate cakes or realize original party favours.



130x65 h 130mm



145x80 h 125mm



145x80 h 95mm



30SMTP04

Misure - Size: 300x400mm
Spessore - Thickness: 9mm

Tappeti in silicone per realizzare topper e decorazioni.
Silicone mat to produce toppers and decorations.

Holy Sacraments

Tappeti e stampi 3D in silicone per realizzare topper e
piece in **cioccolato** o **isomalto** che serviranno a decorare
torte o creare originali bomboniere.

Mats and 3D silicone moulds to prepare **chocolate** or
isomalt toppers and pieces ideal to decorate cakes or
realize original party favours.



165x90 h 140mm



170x90 h 143mm



175x90 h 145mm

Communion and Confirmation 30SMTP05

Misure - Size: 300x400mm
Spessore - Thickness: 9mm



CHOCO TOOLS

Forchette Steel forks set

CHOCOFORK

Set 10 pcs

In filo di acciaio inox con manico in plastica.
Stainless steel wire with plastic handle.



Texture deco per cioccolato Artisan decor sheets

MACLO1

Pack 13 pcs - 360x340 mm

Kit fogli in plastica trasparente per la realizzazione di praline artigianali e decorazioni di cioccolato.
Transparent plastic sheets kit for handmade pralines and chocolate decorations.



PACKAGING



Bordo satinato - Satin glim boxes

Alveoli trasparenti - Transparent cavities
31x26 h 10mm - pack 25 pcs

Misure Size mm	Alveoli Cavities	Codice Code
100x115 h23	6	MSC201
210x100 h23	12	MSC202
210x100 h23	18	MSC203



Scatole trasparenti - Transparent boxes

Alveoli trasparenti - transparent cavities
31x26 h 10mm - pack 25 pcs

Misure Size mm	Alveoli Cavities	Codice Code
160x40 h20	5	MSC001
110x100 h20	9	MSC002
220x65 h20	12	MSC003
160x150 h20	20	MSC004

Mart Box: tagliato da te

Pratico sistema per realizzare il confezionamento perfetto per le tue creazioni, adattandolo ad ogni specifica esigenza. Mart Box è composto da una bobina in plastica trasparente lunga 15 mt che potrà facilmente essere tagliata nella misura desiderata e completata con coperchi double-face.

Mart Box: cut by you

A practical system to realize the perfect packaging for your creations and to adapt it in any specific requirement. Mart Box is composed of a 15 m long transparent plastic reel that can be easily cut up into desired lengths and completed with double-face covers.



Metti in mostra il lato che preferisci: abbina al tuo Mart Box il seguente coperchio double-face.
Show the favourite side: match your Mart Box with the following double-face cover.

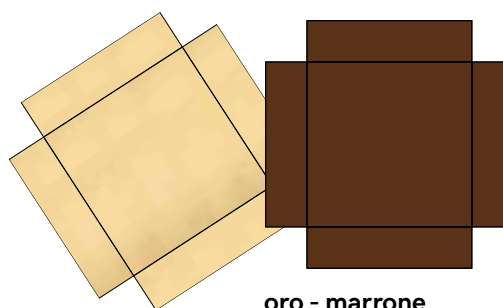

oro - marrone
gold side - brown side

48x48mm
22BOX48

60x60mm
22BOX60

85x85mm
22BOX85

Size mm	pcs	Code
48x48	100	22BOX48T4
60x60	100	22BOX60T4
85x85	100	22BOX85T4

Realizzato in materiale plastico termoresistente, con vasca e coperchio rimovibile in acciaio inox e sonda termica per la regolazione della temperatura del cioccolato. La scheda elettronica gestisce la resistenza interna e la rilevazione della temperatura del cioccolato tramite la sonda esterna per ottimizzare il raggiungimento del risultato richiesto e per consentire un più rapido e preciso scioglimento del cioccolato. Il pannello frontale fornisce suggerimenti per il temperaggio, regolabile manualmente o seguendo i 3 programmi differenti in base al tipo di cioccolato: bianco, al latte o fondente. Le indicazioni del display aiutano l'operatore a completare le fasi del temperaggio e del mantenimento del cioccolato.

DigitalMeltinChoc

MADE IN ITALY

Made of heat-resistant plastic material, with a stainless steel tank and removable lid and a thermal probe for the regulation of the chocolate temperature. The electronic card manages the internal resistance and the chocolate temperature detection through the external probe to optimize the achievement of the required result and to allow a faster and more precise melting of the chocolate.

The front panel provides suggestions for tempering, adjustable manually or by following the 3 different programs according to the type of chocolate: white, milk or dark chocolate. The display indications help the operator to complete the tempering and chocolate maintenance phases.



MCDA103
adatto per scioglitore
9L e 13,7L



KIT SUPPORTO STAMPO E PULISCI SPATOLA IN ACCIAIO INOX
STAINLESS STEEL MOULD SUPPORT AND SPATULA CLEANER

- **Temperatura costante ed omogenea**
Constant and homogenous temperature
- **Vasca estraibile in acciaio inox**
Removable stainless steel basin
- **Programmi selezionabili**
Preset programs
- **Rapido scioglimento**
Quick melting
- **Controllo digitale**
Digital control
- **Display grafico**
Graphic display
- **Sonda termica**
Thermal probe
- **Indicatori sonori**
Sound indicators



Watch the video in
Martellato's YouTube channel.



3,6 L

MCD101

24x40 h13,5cm

Vasca - Basin: 18x32,5 h10cm



6 L

MCD102

33x40 h13,5cm

Vasca - Basin: 26,5x32 h10cm



9 L

MCD103

39,5x45 h13,5cm

Vasca - Basin: 32x35,3 h10cm



13,7 L

MCD104

39,5x62 h13,5cm

Vasca - Basin: 32,5x53 h10cm



Su richiesta disponibili scioglitori con cablaggio
GB / USA / GIAPPONE / AUSTRALIA / CINA.

UK / US / JAPAN / AUSTRALIA / CHINA
wirings available upon request.

Meltingchoc

MADE IN ITALY

MELTINGCHOC ANALOGICI

I Meltingchoc sono degli strumenti indispensabili per la lavorazione del cioccolato. Precisione, design, semplicità e ingombro ridotto sono i principali vantaggi di questi dispositivi in grado di soddisfare anche i pasticceri più esigenti. Gli scioglitori a secco analogici sono dotati di una pratica **vasca in acciaio inox** removibile con scocca in plastica. Il termostato manuale permette di regolare e mantenere il cioccolato alla temperatura desiderata. Realizzati in materiale plastico termoresistente, gli scioglitori per cioccolato hanno capienze comprese tra 0,8 e 13 litri.

ANALOGUE MELTINGCHOC

The Meltingchoc are essential tools for chocolate processing. Precision, design, ease of use and compactness are the main advantages of these devices, designed to meet the requirements of even the most demanding pastry chef. These dry heat analogue melters are equipped with a practical and removable **stainless steel tank** with plastic chassis. The manual thermostat allows you to adjust and maintain the chocolate at the desired temperature. Made with heat-resistant plastic, the chocolate melters can hold from 0,8 to 13 liters.



Scocca in resistente materiale plastico
Shell made of durable plastic material

Termostato a regolazione manuale
Manual regulation thermostat

MONO



1,5 L
MC105

24x26 h13,5cm
Vasca - Basin: 14x15,5 h10cm



3,6 L
MC101

24x40 h13,5cm
Vasca - Basin: 18x32,5 h10cm



6 L
MC102

33x40 h13,5cm
Vasca - Basin: 26,5x32 h10cm



9 L

MC103

39,5x45 h13,5cm
Vasca - Basin: 32x35,3 h10cm



13,7 L

MC104

39,5x62 h13,5cm
Vasca - Basin: 32,5x53 h10cm

MULTI



0,8x3 L

MC107

Misure - Size: 39,5x26,5 h13,5cm
Vasca - Basin: 8,3x15 h10cm
Mono Termostato - Mono-Thermostat



1,5x2 L

MC108

42x26 h13,5cm
Vasca - Basin: 14x15,5 h10cm
Multi Termostato - Multi-Thermostat



1,5x3 L

MC100

61x26 h13,5cm
Vasca - Basin: 14x15,5 h10cm
Multi Termostato - Multi-Thermostat



1,5x4 L

MC106

79x26 h13,5cm
Vasca - Basin: 14x15,5 h10cm
Multi Termostato - Multi-Thermostat

Su richiesta disponibili scioglitori con cablaggio GB / USA / GIAPPONE / AUSTRALIA / CINA.
UK / US / JAPAN / AUSTRALIA / CHINA wirings available upon request.

MiniMeltinChoc

MADE IN ITALY

Il **mini scioglitore a secco per cioccolato** è adatto sia in laboratorio per piccole produzioni di praline e soggetti, che in gelateria per la copertura di gelati e dessert su stecco. La capacità contenuta consente la lavorazione di piccole quantità senza sprechi e la **pratica vasca estraibile** garantisce una manutenzione facile e veloce.

Il **design raffinato** e le **dimensioni ridotte** lo rendono perfetto per l'utilizzo anche direttamente sul bancone.

The **mini dry melter for chocolate** is suitable both in the laboratory for small productions of pralines and subjects, and in ice-cream shops for covering ice cream and desserts on a stick.

The small capacity allows to process tiny chocolate quantities without any waste.

The **practical removable tank** ensures an easy and fast maintenance. The **refined design** and **compact size** make it perfect to be used even directly on the counter.

Nero - Black
MC09N

Rosso - Red
MC09R

Grigio - Gray
MC09G

Lilla - Lilac
MC09L

Verde - Green
MC09V



Termostato a regolazione manuale
Manual regulation thermostat

Scocca in resistente materiale plastico
Shell made of durable plastic material

1,8 L

Misure - Size:
26x26 h16 cm



Vaschetta - Basin
MC000305

Vasca estraibile in alluminio anodizzato
Removable basin in anodized aluminum
Ø 18,5 h10,7 cm

Chocolate

Su richiesta disponibili scioglitori con cablaggio GB / USA / GIAPPONE / AUSTRALIA / CINA.
UK / US / JAPAN / AUSTRALIA / CHINA wirings available upon request.

DeepMeltinchoc

 MADE IN ITALY

Scioglitore a secco pensato per le gelaterie: grazie alla sua forma e dimensione è ideale per coperture in cioccolato di gelati e semifreddi su stecco. Presentato con colorazione classica, che ricorda i toni del cioccolato, per adattarsi ad ogni tipologia di arredo e per essere utilizzato direttamente sul banco.

Le caratteristiche tecniche dello scioglitore analogico, tra cui il termostato che consente di regolare la temperatura e la vasca estraibile in alluminio anodizzato per una più facile pulizia, fanno di DEEP-MELTINCHOC un articolo essenziale.

Dry melter designed for ice-cream shops: thanks to its shape and size it is ideal for chocolate coatings of ice-creams and semifreddos on sticks. Presented with classic colours, reminiscent of chocolate tones, to adapt to all types of furnishings and to be used directly on the counter.

The technical features of the analogue melter, including the thermostat that allows you to adjust the temperature and the removable tank in anodised aluminium for easier cleaning, make DEEP-MELTINCHOC an essential item.



Scocca, coperchio e fondo in resistente materiale plastico
Body, lid and bottom in durable plastic material

1,7 L

Deep Meltinchoc

MC10

Ø 20,5 h21,2 cm



Vaschetta - Basin

MC001001

Vasca estraibile in alluminio anodizzato
Removable basin in anodized aluminum
Ø 14 h18 cm

Su richiesta disponibili scioglitori con cablaggio GB / USA / GIAPPONE / AUSTRALIA / CINA.
UK / US / JAPAN / AUSTRALIA / CHINA wirings available upon request.

Chocobig

EVOLUTION

Versatile, di facile utilizzo e di sicuro effetto. Ideale per pasticcerie, gelateria, ristoranti, alberghi e servizi catering.

La fontana Martellato, realizzata in Italia, è completamente in acciaio inox, ha la vasca smontabile per rendere svuotamento e pulizia molto facili. La manopola consente di regolare la temperatura e lo spegnimento automatico ne evita il surriscaldamento. Per il funzionamento richiede circa 3,5 kg di cioccolato e può contenerne fino a 8 kg.

Versatile, easy to use and highly impactful. Ideal for pastry shops, ice cream parlours, restaurants, hotels and catering services.

The Martellato fountain, made in Italy, is completely in stainless steel and has a removable basin to make emptying and cleaning very easy. The control knob allows you to adjust the temperature and the automatic switch-off prevents overheating. It requires about 3.5 kg of chocolate to operate and can hold up to 8 kg.



CHOCOBIGEV
Ø 380 h800 mm
Capacità: circa 3,5 litri
230V - 50 Hz
Amps 1.6A - 370W



- ✓ MADE IN ITALY
- ✓ FUNZIONAMENTO SILENZIOSO
SILENT OPERATION
- ✓ COCLEA IN ACCIAIO INOX
STAINLESS STEEL AUGER
- ✓ VASCA SMONTABILE
DISASSEMBLING BOWL

ACCESSORI - ACCESSORIES

Copri fontana in plexiglass con comodi ripiani.
Plexiglass ring cover for chocolate fountain with useful displayers.

CHOCOBIGRING
Rosso - Red
Ø 650 mm x h 170mm

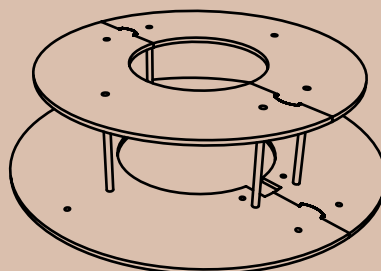

CHOCOBIGRING06
Satinato - Satin-finish
Ø 650 mm x h 170mm

Chocolate Fountain



CHOCOFONT

Ø 210mm h390mm
Capacità: circa 1 litro
220 - 240V - 50 Hz
Amps 0,77A - 170W

Compatta e leggera, la più piccola delle nostre fontane è adatta a sciogliere e mantenere il cioccolato alla temperatura desiderata nelle occasioni più informali o con spazi contenuti.

Compact and light, the smallest of our fountains is suitable for melting and maintaining chocolate at the desired temperature on the most informal occasions or with limited space.

- ✓ FONTANA IN ACCIAIO INOX
STAINLESS STEEL FOUNTAIN
- ✓ COCLEA IN PLASTICA RESISTENTE
AUGER IN HEAT RESISTANT PLASTIC
- ✓ PIEDINI REGOLABILI
ADJUSTABLE FEET

Mantiene la cioccolata alla temperatura di 36/39°C.
It keeps the chocolate at a temperature of 36/39°C.

ACCESSORI - ACCESSORIES

Copri fontana in plexiglass con comodi ripiani.
Plexiglass ring cover for chocolate fountain with useful displays.

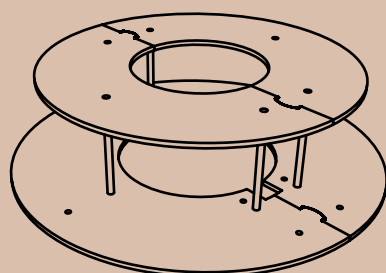

CHOCORING06

Satinato - Satin-finish
Ø 520mm x h 160mm

SEMIFREDDO & BAKING

TRAVEL CAKE
—○—
Geometric
by
FRANK HAASNOOT

Dalla collaborazione tra Martellato e **Frank Haasnoot** nascono **nuove forme** per interpretare l'iconico Travel cake. Stampi in **acciaio inox**, realizzati in Italia, con inserto tubolare facilmente estraibile dopo la cottura, per consentire la farcitura del dolce anche con ripieni non da forno.





New shapes come from the collaboration between Martellato and **Frank Haasnoot**, to interpret the iconic Travel cake. Made in Italy **stainless steel moulds** with an easily removable after baking tubular insert, to fill the cakes with non-baked fillings.



CARRÉ

30TC51F

Mould 82 x 290 h 64 mm
Cake 60 x 250 h 60 mm
Vol. ~ 900 ml
Prod. su teglia/on tray 60x40: 8 pcs

30TC50F

Mould 103 x 190 h 70 mm
Cake 80 x 150 h 69 mm
Vol. ~ 850 ml
Prod. su teglia/on tray 60x40: 10 pcs



TRIANGLE

30TC52F

Mould 88 x 290 x h 85 mm
Cake 82 x 250 h 80 mm
Vol. ~ 890 ml
Prod. su teglia/on tray 60x40: 6 pcs



FANCY

30TC53F

Mould 83,5 x 290 h 86 mm
Cake 60 x 250 h 80 mm
Vol. ~ 960 ml
Prod. su teglia/on tray 60x40: 8 pcs

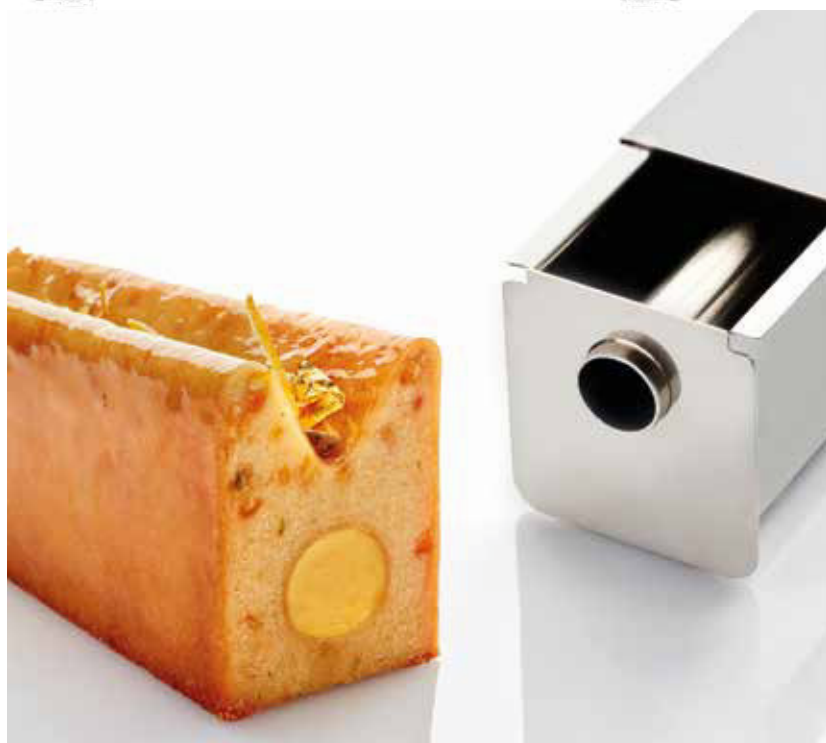

ROUND

30TC54F

Mould Ø 82 x 290 mm
Cake Ø 78 x 250 mm
Vol. ~ 1050 ml
Prod. su teglia/on tray 60x40: 8 pcs



i MICRO BANDS FORATI

The perfect baking solution

Fasce in silicone microforato, che abbinare agli stampi in acciaio inox, garantiscono cottura omogenea e senza umidità, sfornatura facile senza rotture e una texture regolare ed elegante.

Micro-perforated silicone bands, which combined with the stainless steel moulds, guarantee even cooking without humidity, easy demoulding without breakings and a regular and elegant texture.

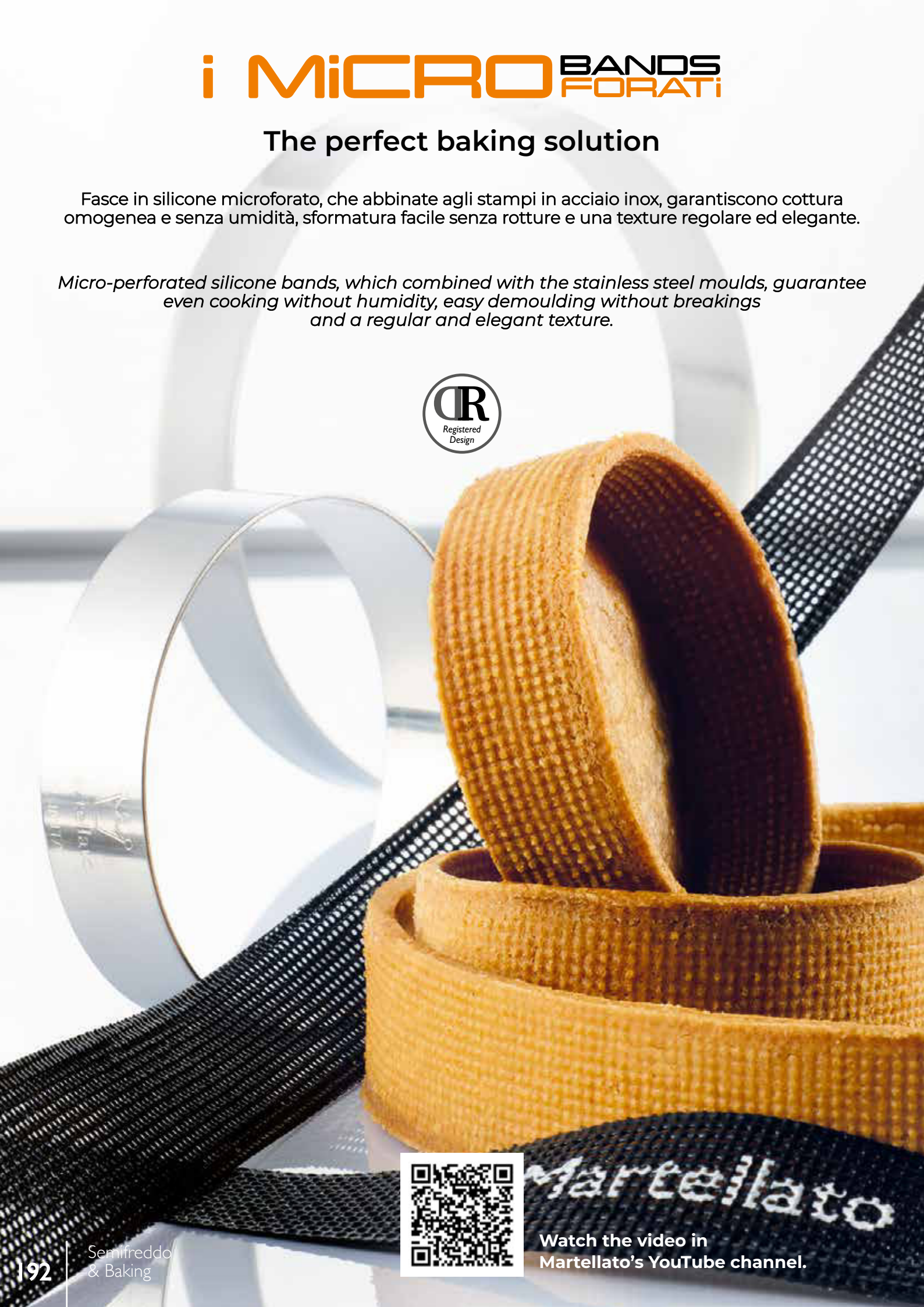

Watch the video in
Martellato's YouTube channel.

"I MicroforatiBands sono la soluzione ideale per la razionalizzazione della produzione, la riduzione degli sprechi e un risultato estetico ineguagliabile."

"The MicroforatiBands are the ideal solution for production optimization, waste reduction and unique aesthetics results"

Denis Dianin AMPI Pastry Chef



EFFICIENZA PRODUTTIVA

- **RAZIONALIZZAZIONE DELLA PRODUZIONE**
semplificando i passaggi e riducendo i tempi di circa il 30%
- **COTTURA OMOGENEA E SENZA IMPERFEZIONI**
in quanto permette la fuoriuscita dell'umidità
- **SFORMATURA VELOCE E SENZA ROTTURE**
favorendo la rimozione del prodotto sia a caldo che a freddo
- **RIDUZIONE DEGLI SPRECHI E DEI COSTI**
meno spreco di prodotto perché si avrà il 99 % di successo nella produzione



PRODUCTION OPTIMIZATION

- **PRODUCTION RATIONALIZATION**
by simplifying the steps and reducing times by around 30%
- **EVEN COOKING WITH ZERO IMPERFECTIONS**
because they allow moisture to escape
- **QUICK DEMOULDING WITHOUT BREAKINGS**
by allowing the unmoulding of both hot and cold products
- **WASTE AND COST REDUCTION**
less product waste because you will have a 99% success rate with your production





RISULTATI PERFETTI

- **ADATTABILITÀ A TUTTE LE FORME E A TUTTE LE RICETTE**
- **TEXTURE ELEGANTE** ed esclusiva
- **BORDI SOTTILI e DRITTI**
che non collassano perché sostenuti dalla fascia
- **MINIMO SPAZIO DI STOCCAGGIO e FACILE GESTIONE**
lavaggio ed asciugatura rapidi







PERFECT RESULTS

- **ADAPTABILITY TO ALL SHAPES AND RECIPES**
- **ELEGANT AND EXCLUSIVE** texture
- **THIN AND STRAIGHT EDGES**
that don't collapse because supported by the band
- **MINIMUM STORAGE AREA AND EASY MANAGEMENT**
quick washing and drying



MODELLI MODELS

i MICROBANDS FORATI

30BANDS01	500xh25 mm 10 pcs	for	Ø 14 - 16	h 2,5 cm	
30BANDS02	625xh25 mm 10 pcs	for	Ø 18 - 20	h 2,5 cm	
30BANDS03	750xh25 mm 10 pcs	for	Ø 22 - 24	h 2,5 cm	
30BANDS04	500xh35 mm 10 pcs	for	Ø 14 - 16	h 3,5 cm	
30BANDS05	625xh35 mm 10 pcs	for	Ø 18 - 20	h 3,5 cm	
30BANDS06	750xh35 mm 10 pcs	for	Ø 22 - 24	h 3,5 cm	
30BANDS07	260xh20 mm 20 pcs	for	Ø 8	h 2 cm	



 **+230°C**
+446°F



PRODOTTI CORRELATI

RELATED PRODUCTS

Fasce inox Stainless steel bands



1H2X8	Ø8 h2 cm
1H25X14	Ø14 h2,5 cm
1H25X16	Ø16 h2,5 cm
1H25X18	Ø18 h2,5 cm
1H25X20	Ø20 h2,5 cm
1H25X22	Ø22 h2,5 cm
1H25X24	Ø24 h2,5 cm
1H35X14	Ø14 h3,5 cm
1H35X16	Ø16 h3,5 cm
1H35X18	Ø18 h3,5 cm
1H35X20	Ø20 h3,5 cm
1H35X22	Ø22 h3,5 cm
1H35X24	Ø24 h3,5 cm



5H25X14	14X14 h2,5 cm
5H25X16	16X16 h2,5 cm
5H25X18	18X18 h2,5 cm
5H35X14	14X14 h3,5 cm
5H35X16	16X16 h3,5 cm
5H35X18	18X18 h3,5 cm

Tappeto in silicone microforato Micro-perforated silicone mat



 **+230°C**
+446°F

MICROMAT60 38,5 x 58,5 cm

MICROMAT30 38,5 x 28,5 cm

Dime - Template

Dime in plastica trasparente per il taglio in strisce regolari di pastafrolla, cioccolato e biscuit.

Transparent plastic grids for cutting regular strips of pastry, chocolate and biscuit.

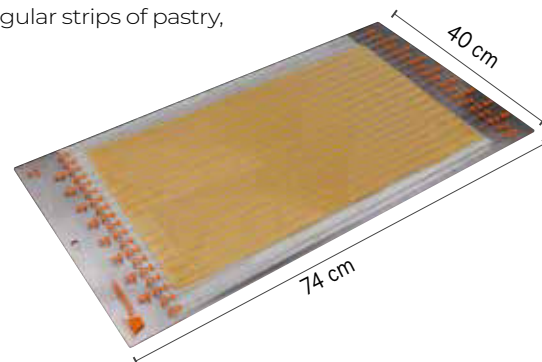

50GD0022 prod. 15 str. 60 x h2,2 cm

50GD0027 prod. 12 str. 60 x h2,7 cm

50GD0037 prod. 9 str. 60 x h3,7 cm

Guarda il video tutorial de "I microforati bands" nel canale Youtube Martellato
Watch the video tutorial "I microforati bands" on the Martellato Youtube channel

i MICRO FORATI

stampi silicone
silicone moulds

30x40

1 box: 2 stampi/moulds

Una linea di prodotti per cotture in forno, realizzati in silicone e fibra di vetro, pensati per facilitare il lavoro in laboratorio.

Le caratteristiche che li contraddistinguono, come l'alta qualità dei materiali e la texture microforata, consentono la diffusione uniforme del calore e l'uscita dell'umidità, riducendo i tempi di cottura e garantendo un risultato perfetto.

Tante forme ideali per le diverse preparazioni sia dolci che salate, come tartellette classiche e moderne, brioche e muffin.

Le creazioni risulteranno perfettamente croccanti e dalla forma impeccabile, senza bolle o cedimenti. Sono ideali anche per i lievitati, pasta frolla e brisée. I tappeti sono antiaderenti e possono essere usati da entrambi i lati, per preparare tartellette vuote o già farcite.

A line of products for oven baking, made of silicone and fibreglass, designed to simplify work in the laboratory.

The characteristics that distinguish them, such as the high quality of the materials and the micro-perforated texture, allow the uniform diffusion of heat and the exit of humidity, reducing cooking times and guaranteeing a perfect result.

The many different shapes are ideal for various preparations, both sweet and savoury, such as classic and modern tartlets, brioche and muffins.

The creations will be perfectly crunchy and impeccably shaped, without bubbles or sagging. They are also ideal for leavened products, shortcrust pastry and brisée.

The mats are non-stick and can be used on both sides to prepare empty or already filled tartlets.

1 confezione = 2 stampi 30x40 per teglie 60x40

1 pack = 2 moulds 30x40 for 60x40 trays

PLUS

Scopri i valori aggiunti che rivoluzionano la cottura in forno.
Discover the added values that revolutionise oven cooking.

RESISTENTI

Il silicone arricchito con fibra di vetro garantisce alta qualità e maggiore durata degli stampi.

Resiste a temperature fino a:
+230°C +450°F

RESISTANT

The silicone enriched with glass fibre guarantees high quality and longer life of the moulds.

Resistent up to:
+ 230 ° C + 450 ° F

PRATICI

Le sfornature sono più facili grazie all'antiaderenza del materiale

PRACTICAL

Demoulding is easier thanks to the material non-stick qualities

FUNZIONALI

La microforatura assicura una cottura veloce e uniforme, priva dell'umidità in eccesso

FUNCTIONAL

Microperforation ensures even and quick cooking with no humidity excess

VERSATILI

Possono essere usati da entrambi i lati per risultati creativi

VERSATILE

Can be used on both sides for creative results

MULTIUSO

Consentono di realizzare qualsiasi tipo di ricetta, dolce o salata

MULTI-USE

Allow making any type of sweet or savoury recipe

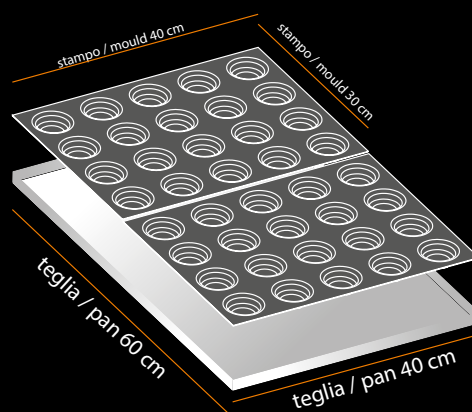

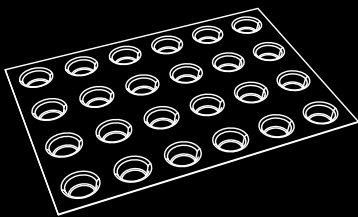

h16

Ø40mm

30MICRO01

Prod: 24+24 pcs

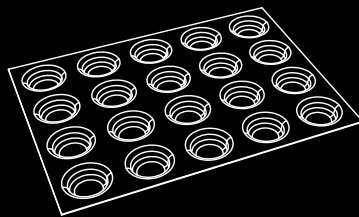

h16

Ø50mm

30MICRO02

Prod: 20+20 pcs

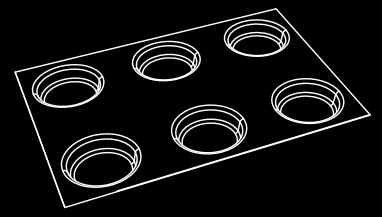

h20

Ø85mm

30MICRO04

Prod: 6+6 pcs

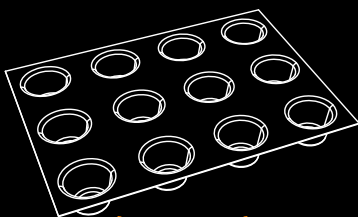

h40mm

Ø60mm

30MICRO03

Prod: 12+12 pcs

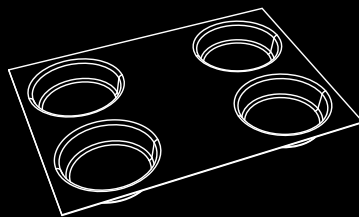

h30mm

Ø120mm

30MICRO05

Prod: 4+4 pcs

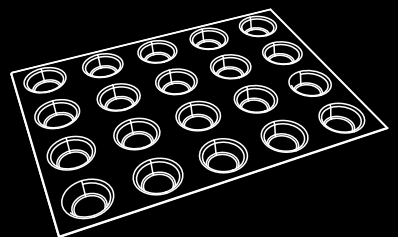

h22

Ø48mm

30MICRO10

Prod: 20+20 pcs

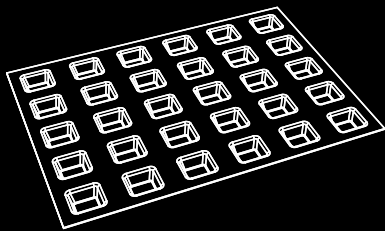

h16
35x35mm

30MICRO06
Prod: 30+30 pcs

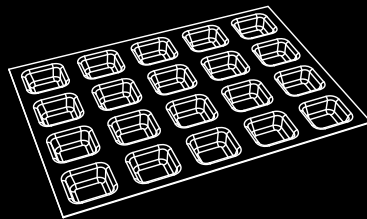

h20
50x50mm

30MICRO07
Prod: 20+20 pcs

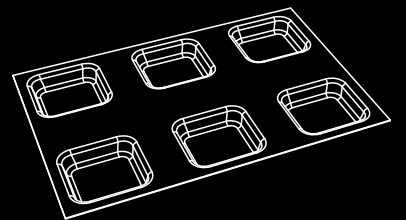

h20
85x85mm

30MICRO08
Prod: 6+6 pcs

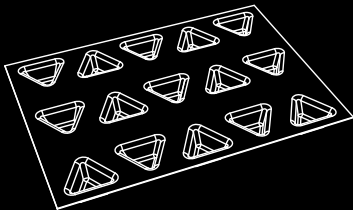

h25mm
60mm

30MICRO09
Prod: 15+15 pcs

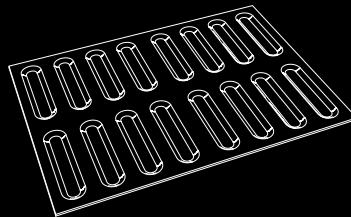

h6mm
120mm

30MICRO11
Prod: 16+16 pcs
120x25 - h6mm





One Strip

La Rivoluzione degli Stampi

Una nuova generazione di stampi che stanno cambiando il modo di lavorare in laboratorio.

Pratici, economici e veloci, gli stampi monouso per torte e individual cake consentono di velocizzare la produzione, risparmiando tempo e riducendo i costi.

The Moulds Revolution

A new generation of moulds that are changing the way professionals work in the laboratory.

Practical, economical and fast, the disposable moulds for cakes and individual desserts allow to speed up the production, saving time and reducing costs.

MADE IN ITALY

**100% RECYCLABLE
THERMOFORMED PLASTIC** 

“ One Strip è l'opportunità per il pasticcere di lavorare più velocemente, risparmiando tempo e spazio: un'occasione di guardare al futuro.

One Strip is the opportunity for the pastry chef to work faster, saving time and space: a chance to look at the future. **”**



Champion du Monde
LUIGI BIASETTO for MARTELLATO



Plus Produttivi

- **RISPARMIO** di tempo, lavoro e spazio
- **PRODUZIONE PIÙ VELOCE**, con meno passaggi
- **RAFFREDDAMENTO RAPIDO** rispetto al silicone
- **SFORMATURA PRECISA** e senza rotture
- **STOCCAGGIO DIRETTO** degli stampi

Production plus

- **SAVINGS** of time, work and space
- **FASTER PRODUCTION**, with less steps
- **FAST CHILLING**, even more than silicone
- **PRECISE DEMOULDING** without any breaking
- **DIRECT** moulds storage



Perché scegliere One Strip?

Con gli stampi One Strip si avrà la RIDUZIONE del:

30% dei **TEMPI** di produzione

15% del **COSTO** dei materiali

20% della **MANODOPERA**

25% dei **CONSUMI**

Sarà possibile risparmiare fino al 30% dei costi di produzione, rendendola più efficiente ed organizzata.

Why choose One Strip?

One Strip moulds allow:

*30% reduction of production **TIMES***

*15% reduction of **COSTS** of the materials;*

*20% reduction of the **LABOUR***

*25% reduction of **ENERGY CONSUMPTION***

It will be possible to save the production costs up to 30% by making it more efficient and organized.



One Strip

Caratteristiche

- **MATERIALE 100%** riciclabile 
- **FORMA** semplice ed essenziale
- **MASSIMA** igiene
- **NESSUNA** contaminazione
- **MADE IN ITALY**
- **ALTA PRODUTTIVITÀ** per teglia
- **SCRIVIBILI** per l'etichettatura
- **BIANCHI** per evidenziare residui

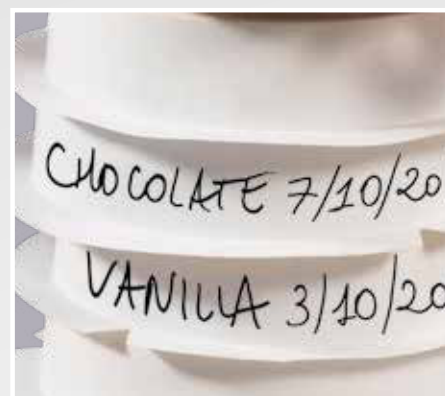



Features

- **100% RECYCLABLE** material 
- **ESSENTIAL AND SIMPLE** shape
- **MAXIMUM HYGIENE**
- **NO** contamination
- **MADE IN ITALY**
- **HIGH** productivity
- **WRITEABLE** for the labeling
- **WHITE** to highlight residues



Models

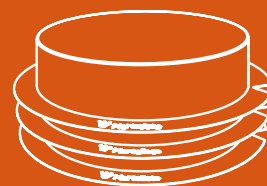

Cake Mould

ONE16 Ø160 x h40 mm	ONE20 Ø200 x h40 mm
ONE18 Ø180 x h40 mm	ONE22 Ø220 x h40 mm

Pack 100 pcs



Individual Cake

6 pcs/bar

ONE06
Ø63 x h40 mm
bar size 391 x 66 h 40

Prod. for 60x40 tray
6x9=54 pcs

Pack 72 bars

Scopri di più su martellato.com
Discover more on martellato.com



LE COMPONENTI INOX

CAKE IDEA presenta un nuovo concetto di componibilità verticale, per consentire ai pasticceri più innovativi e creativi di offrire torte multigusto e multiconsistenza, sempre più sorprendenti, con preparazioni semplici e veloci. Gli stampi permetteranno una costruzione stratificata del dolce, grazie alla presenza di un top essenziale per la creazione con diverse consistenze e che funge anche da elemento decorativo, permettendo giochi di volumi.

CAKE IDEA presents a new concept of vertical modularity, to allow the most innovative and creative confectioners to offer multi-flavoured and multiconsistency cakes, more and more surprising, with simple and quick preparations. The moulds will allow a layered construction of the cake, thanks to the presence of a top essential for creating with different consistencies and which also acts as a decorative element, allowing games of volumes.





RING

50KIT18

KIT COMPONENTI
Pack 3 pcs
Base: Ø18 h3 cm
Insert: Ø16 h2 cm
Top: Ø14 h2 cm
Cap. 1000 ml

50KIT20

KIT COMPONENTI
Pack 3 pcs
Base: Ø20 h3 cm
Insert: Ø18 h2 cm
Top: Ø16 h2 cm
Cap. 1300 ml



Gli stampi dei CAMPIONI DEL MONDO

CAKE IDEA è stata protagonista dell'edizione 2020 della Coppa del Mondo della Gelateria. Le squadre in gara si sono contestate il titolo di Campioni del Mondo con le ultime novità del sistema di fasce inox componibili, grazie alle quali è possibile dare forma alla creatività.

The moulds of the WORLD CHAMPIONS

CAKE IDEA was the protagonist of the 2020 edition of the Ice Cream World Cup. The participating teams competed for the title of World Champion with the latest innovations in the system of modular stainless steel bands, thanks to which it is possible to give shape to creativity.

LE COMPONENTI INOX



FRAME

51KIT18
KIT COMPONENTI
Pack 3 pcs
Base: 18x18 h3 cm
Insert: 16x16 h2 cm
Top: 14x14 h2 cm
Cap. 1300 ml



ELLIPSE

52KIT27

KIT COMPONENTI

Pack 3 pcs

Base: 27x12 h3 cm

Insert: 25x10 h2 cm

Top: 23x8 h2 cm

Cap. 1100 ml

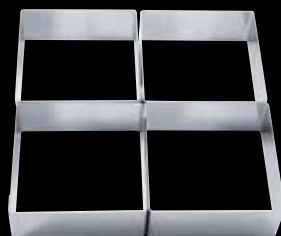

4 TASTE

38H4X22S

4 Moulds: 10x10 h4 cm
Pack 4 pcs
Cap. 1600ml



4 TASTE KIT

38KITH4X22

Pack 9 pcs
4 Insert: 8x8 h2 cm
4 Moulds: 10x10 h4 cm
1 Base: 22x22 h2 cm
Cap. 1600ml

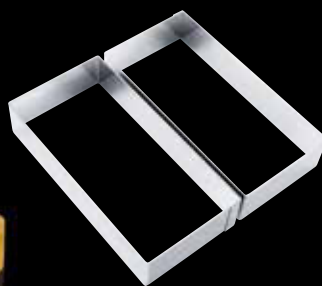

DOUBLE

37H4X22S

2 Moulds: 10x20 h4 cm
Pack 2 pcs
Cap. 1600ml

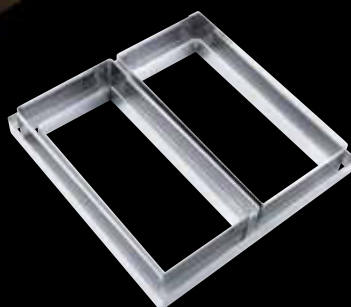

DOUBLE KIT

37KITH4X22

Pack 5 pcs
2 Insert: 18x8 h2 cm
2 Moulds: 10x20 h4 cm
1 Base: 22x22 h2 cm
Cap. 1600ml

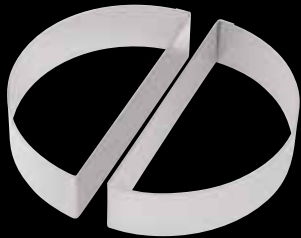

DEMI 18

39H4X20S

Mould: Ø18 h4 cm
Pack 2 pcs
Cap. 985ml

39KITH4X20

KIT COMPONIBILI
Pack 6 pcs
Insert: Ø16 h2 cm
Mould: Ø18 h4 cm
Base: Ø20 h2 cm
Cap. 985ml



DEMI 22

39H4X24S

Mould: Ø22 h4 cm
Pack 2 pcs
Cap. 1473ml

39KITH4X24

KIT COMPONIBILI
Pack 6 pcs
Insert: Ø20 h2 cm
Mould: Ø22 h4 cm
Base: Ø24 h2 cm
Cap. 1473ml



MOON

36H4X22S

2 Moulds: Ø20 h4 cm
Pack 2 pcs
Cap. 1100ml

MOON KIT

36KITH4X22

Pack 5 pcs
2 Inserts: Ø28 h2 cm
2 Moulds: Ø20 h4 cm
1 Base: Ø22 h2 cm
Cap. 1100ml



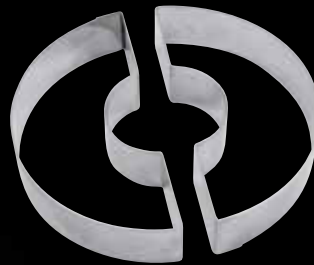

DUETTO 19

33H4X20S
2 Moulds: Ø19 h4 cm
Pack 2 pcs
Cap. 950ml

DUETTO 23

33H4X24S
2 Moulds: Ø23 h4 cm
Pack 2 pcs
Cap. 1400ml



DUETTO 19 KIT

33KITH4X20
2 Insert: Ø17 h2 cm
2 Moulds: Ø19 h4 cm
2 Base: Ø22 h2 cm
Cap. 950ml

DUETTO 23 KIT

33KITH4X24
2 Insert: Ø21 h2 cm
2 Moulds: Ø23 h4 cm
2 Base: Ø25 h2 cm
Cap. 1400ml



HEART 14

35H4X14S
2 Moulds: 14x14 h4 cm
Pack 2 pcs
Cap. 530ml

HEART 19

35H4X19S
2 Moulds: 19x19 h4 cm
Pack 2 pcs
Cap. 1000ml



HEART 19 KIT

35KITH4X19
2 Insert: 15x8 h2 cm
2 Moulds: 19x19 h4 cm
Cap. 1000ml



TWINS 16

34H4X16S

2 Moulds: 16x16 h4 cm
Pack 2 pcs
Cap. 950ml

TWINS 20

34H4X20S

2 Moulds: 20x20 h4 cm
Pack 2 pcs
Cap. 1400ml



TWINS 16 KIT

34KITH4X16

2 Insert: 13x13 h2 cm
2 Moulds: 16x16 h4 cm
2 Base: 17x17 h2 cm
Cap. 950ml

TWINS 20 KIT

34KITH4X20

2 Insert: 16x16 h2 cm
2 Moulds: 20x20 h4 cm
2 Base: 24x24 h2 cm
Cap. 1400ml

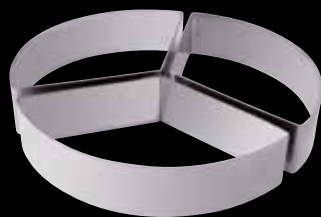

TRILOGY 18

32H4X18S

3 Moulds: Ø18 h4 cm
Pack 3 pcs
Cap. 950ml

TRILOGY 22

32H4X22S

3 Moulds: Ø22 h4 cm
Pack 3 pcs
Cap. 1400ml





Created by  **FRANK
HAASNOT**

pastry RING

Fasce in acciaio inox di alta qualità con **bordi perfettamente dritti**, spessi per maggiore indeformabilità e **superficie liscia** per facilità di sformatura e dessert impeccabili. Adatti all'utilizzo sia in forno dove assicurano cottura uniforme che in congelatore ed in abbattitore per un completo e veloce raffreddamento. La varietà di forme e dimensioni, unita alle ampie possibilità di personalizzazione del soggetto su richiesta, rendono le fasce Martellato delle **soluzioni versatili** in grado di soddisfare anche i pasticceri più esigenti.

High quality stainless steel cake band with **perfectly straight edges**, more thicker for greater non-deformability and **smooth surface** for ease demoulding and flawless desserts. Suitable for use in freezer and blast chiller for a complete and fast cooling and ensure even cooking. The variety of shapes and sizes, combined with the wide customization opportunities upon request, make Martellato rings **very versatile products** able to satisfy even the most demanding pastry chefs.





ROUND

H. 60 mm

1H6X6	Ø 6	170	ml
1H6X8	Ø 8	300	ml
1H6X10	Ø 10	470	ml
1H6X12	Ø 12	680	ml
1H6X14	Ø 14	920	ml
1H6X16	Ø 16	1200	ml
1H6X18	Ø 18	1520	ml
1H6X20	Ø 20	1880	ml
1H6X22	Ø 22	2280	ml

ROUND

H. 40 mm

1H4X8	Ø 80
1H4X10	Ø 100
1H4X12	Ø 120
1H4X14	Ø 140
1H4X16	Ø 160
1H4X18	Ø 180
1H4X20	Ø 200
1H4X22	Ø 220
1H4X24	Ø 240
1H4X26	Ø 260
1H4X28	Ø 280
1H4X30	Ø 300

H. 50 mm

1H5X10	Ø 100
1H5X12	Ø 120
1H5X14	Ø 140
1H5X16	Ø 160
1H5X18	Ø 180
1H5X20	Ø 200
1H5X22	Ø 220
1H5X24	Ø 240
1H5X26	Ø 260
1H5X28	Ø 280
1H5X30	Ø 300

H. 35 mm

1H35X14	Ø 140
1H35X16	Ø 160
1H35X18	Ø 180
1H35X20	Ø 200
1H35X22	Ø 220
1H35X24	Ø 240

ROUND

H. 20 mm

1H2X8	Ø 80
1H2X10	Ø 100
1H2X12	Ø 120
1H2X14	Ø 140
1H2X16	Ø 160
1H2X18	Ø 180
1H2X20	Ø 200
1H2X22	Ø 220
1H2X24	Ø 240
1H2X26	Ø 260
1H2X28	Ø 280

H. 25 mm

1H25X14	Ø 140
1H25X16	Ø 160
1H25X18	Ø 180
1H25X20	Ø 200
1H25X22	Ø 220
1H25X24	Ø 240





DONUT

43H4X18

Ø 18 h 4 cm
foro/hole Ø 10 cm
700 ml

43H4X20

Ø 20 h 4 cm
foro/hole Ø 12 cm
800 ml

SQUARE

H. 40 mm

5H4X10	102x102
5H4X12	122x122
5H4X14	142x142
5H4X16	162x162
5H4X18	182x182
5H4X20	202x202
5H4X22	222x222
5H4X24	242x242
5H4X26	262x262
5H4X28	282x282
5H4X30	302x302

H. 50 mm

5H5X10	102x102
5H5X12	122x122
5H5X14	142x142
5H5X16	162x162
5H5X18	182x182
5H5X20	202x202
5H5X22	222x222
5H5X24	242x242
5H5X26	262x262
5H5X28	282x282
5H5X30	302x302

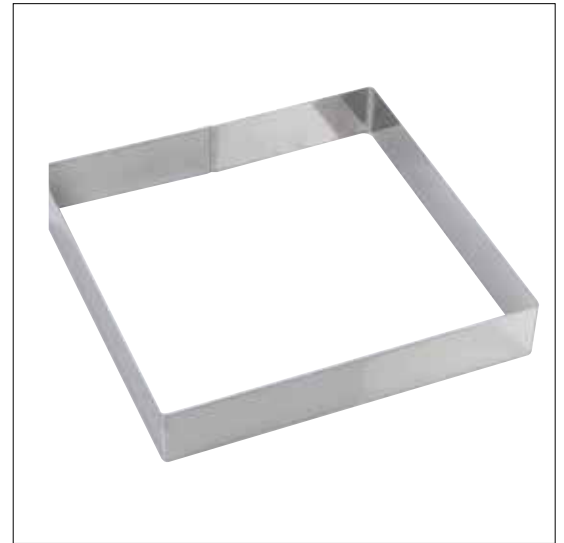

H. 25 mm

5H25X14	142x142
5H25X16	162x162
5H25X18	182x182

H. 35 mm

5H35X14	142x142
5H35X16	162x162
5H35X18	182x182

H. 60 mm

5H6X6	60x60
5H6X8	80x80
5H6X10	102x102
5H6X12	122x122

HEXAGONAL

H. 40 mm

3H4X6	125x140
3H4X8	140x160
3H4X10	175x200
3H4X12	210x240
3H4X14	245x280

H. 50 mm

3H5X6	125x140
3H5X8	140x160
3H5X10	175x200
3H5X12	210x240
3H5X14	245x280





HEART

H. 50 mm

42H5X10	Ø 10	315	ml
42H5X12	Ø 12	455	ml
42H5X14	Ø 14	620	ml
42H5X16	Ø 16	820	ml
42H5X18	Ø 18	1030	ml
42H5X20	Ø 20	1280	ml
42H5X22	Ø 22	1550	ml
42H5X24	Ø 24	1845	ml
42H5X26	Ø 26	2170	ml
42H5X28	Ø 28	2540	ml

H. 40 mm

42H4X10	Ø 10	250	ml
42H4X12	Ø 12	360	ml
42H4X14	Ø 14	490	ml
42H4X16	Ø 16	650	ml
42H4X18	Ø 18	820	ml
42H4X20	Ø 20	1020	ml
42H4X22	Ø 22	1240	ml
42H4X24	Ø 24	1480	ml
42H4X26	Ø 26	1730	ml
42H4X28	Ø 28	2030	ml



HEART

H. 40 mm

18H4X17	175x180
18H4X20	200x206
18H4X26	260x268

H. 50 mm

18H5X17	175x180
18H5X20	200x206
18H5X26	260x268



CALISSON

41H4X9	9 x 5 h 4 cm	120 ml
41H4X15	15 x 8 h 4 cm	350 ml
41H4X22	22 x 12 h 4 cm	750 ml



OVAL

H. 40 mm

2H4X10	115x85
2H4X12	135x100
2H4X14	160x120
2H4X16	185x135
2H4X18	205x155
2H4X20	225x175
2H4X22	253x190
2H4X24	270x210
2H4X26	300x220
2H4X28	320x250
2H4X30	345x260



DROP

H. 40mm

8H4X10	130x82
8H4X12	155x100
8H4X14	175x115
8H4X16	205x127
8H4X18	225x146
8H4X20	250x165
8H4X22	270x180
8H4X24	300x196
8H4X26	325x210
8H4X28	330x255
8H4X30	355x270



Easter

EGG

H. 40mm

27H4X12	121x180
27H4X13	134x200
27H4X14	148x220
27H4X16	161x240



DOVE

H. 40mm

15H4X25	250x140
15H4X30	300x160
15H4X34	340x180



Christmas

TREE

H. 40mm

14H4X16	158x125
14H4X20	210x165
14H4X24	240x190
14H4X30	300x235

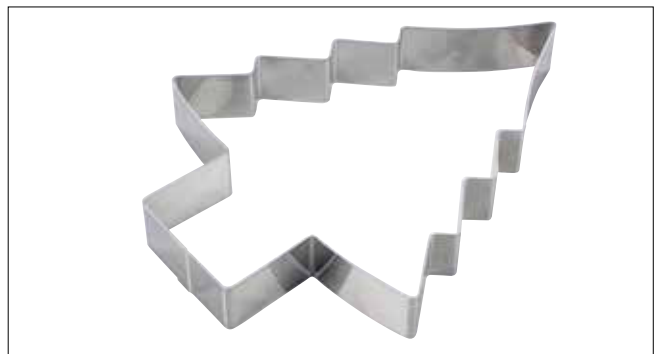

COMET

H. 40mm

13H4X15	150x65
13H4X23	220x95
13H4X30	320x125



RECTANGULAR

H. 40 mm

11H4L24	243x142
11H4L26	263x164
11H4L28	282x183
11H4L30	302x222
11H4L36	360x165
11H4L38	382x262
11H4L40	403x320

H. 50 mm

11H5L24	243x142
11H5L26	263x164
11H5L28	282x183
11H5L30	302x222
11H5L36	360x165
11H5L38	382x262
11H5L40	403x320



BIG RECTANGULAR

H. 40 mm

RETH4	380x580
11H4L56	560x360
11H4L59	595x395

H. 50 mm

RETH5	380x580
11H5L56	560x360
11H5L59	595x395



FANCY

H. 40 mm

23H4X25	250x90
23H4X30	300x91
23H4X35	350x92

H. 50 mm

23H5X25	250x90
23H5X30	300x91
23H5X35	350x92



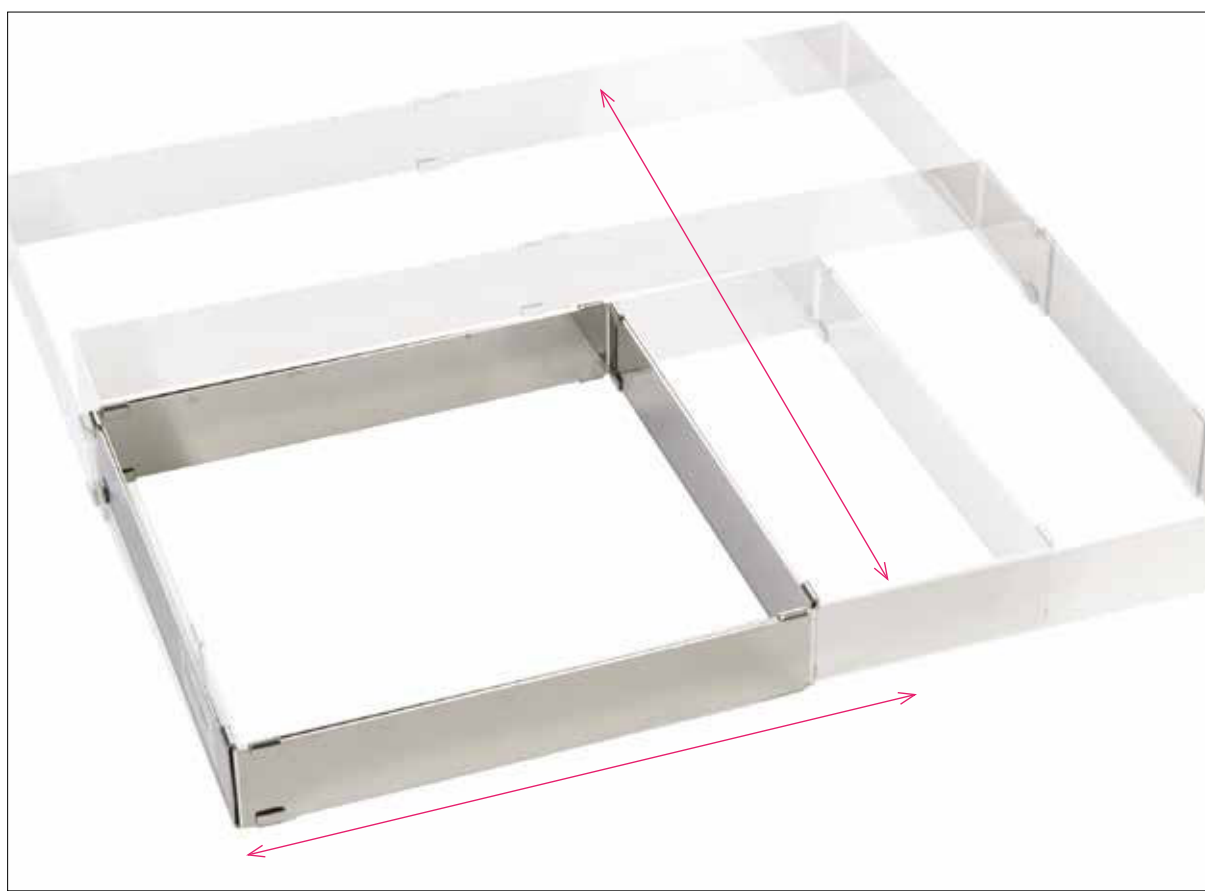

SPECIAL

RETSPECIAL 1

Min 30,5x30,5
Max 57x56
h 4 cm

RETSPECIAL 2

Min 30,5x30,5
Max 57x56
h 5 cm

Telaio regolabile in lunghezza ed in larghezza.
Extendable st. steel frame, lenght and width adjustable.

FOOD PLATING

ROUND

SQUARE

H **60** MM

H **40** MM

H **60** MM

H **40** MM

KIT 2 pcs
70H602
Ø 100 -120

KIT 2 pcs
70H402
Ø 100 -120

KIT 2 pcs
71H602
LATO 100 -120

KIT 2 pcs
71H402
LATO 100 -120

KIT 3 pcs
70H603
Ø 60 - 70 - 80

KIT 3 pcs
70H403
Ø 60 - 70 - 80

KIT 3 pcs
71H603
LATO 60 - 70 - 80

KIT 3 pcs
71H403
LATO 60 - 70 - 80



NUMBERS CAKE



Number	Size H.300 mm	Cod. Code	Cap. ml
0	300x160h40	40H4X10	1900
1	300x93 h 40	40H4X01	1200
2	300x160h40	40H4X02	1800
3	300x160h40	40H4X03	1650
4	300x170h40	40H4X04	1750
5	300x160h40	40H4X05	1800
6	300x160h40	40H4X06	1950
7	300x160h40	40H4X07	1350
8	300x160h40	40H4X08	2000
9	300x160h40	40H4X09	1950

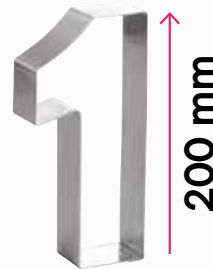
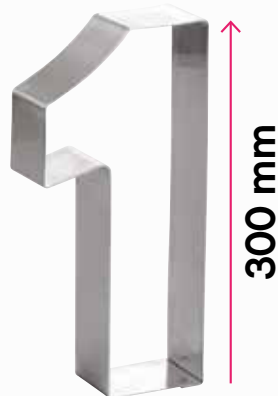

Number	Size H.200 mm	Cod. Code	Cap. ml
0	200x160h40	30H4X10	850
1	200x93 h 40	30H4X01	520
2	200x160h40	30H4X02	800
3	200x160h40	30H4X03	740
4	200x170h40	30H4X04	780
5	200x160h40	30H4X05	800
6	200x160h40	30H4X06	870
7	200x160h40	30H4X07	600
8	200x160h40	30H4X08	900
9	200x160h40	30H4X09	870

SPECIALE NATALE CHRISTMAS SPECIAL

Stampi pandoro in alluminio 10/10
Aluminium 10/10 pandoro moulds

250 gr
30SP0250
Ø 16,5 h 13 cm

500 gr
30SP0500
Ø 19,5 h 14,5 cm

750 gr
30SP0750
Ø 20,5 h 15,5 cm

1000 gr
30SP1000
Ø 23 h 17 cm



100 gr
30SP0100
Ø 10,8 h 8 cm

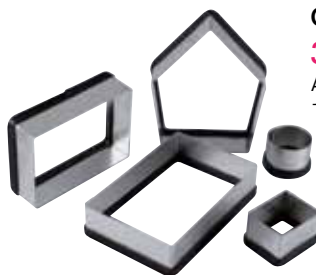

Stampo Casetta di Natale
Gingerbread House Cutter

30CH001

Acciaio inox - Stainless steel
120x138 h 140mm



GHIERA PER LIEVITATI

Realizzata con punte in acciaio inox, è adatta al contatto alimentare.

Di facile impilamento sia su carrelli che su rastrelliere murali.

Perfetto ancoraggio con tutti i tipi di stampi (colombe-stelle-cake-alberi etc..).

Impugnatura salda e sicura.

Ghiera in acciaio inox che permette una chiusura ottimale.

Support with nails for leavened doughs

Tips made of stainless steel and therefore suitable for food contact.

Easy to stack both on trolleys and wall racks.

Perfect adhesion on all types of moulds (colombe-stars-cake-trees etc..)

Firm and safe grip.

Stainless steel nail for optimal fastening.

Aghi girapanettoni lievitati
Pin to turn "panettoni"

53GP01 - 10 PCS

Spessore ago - Pin thickness: 2 mm

Lunghezza totale - Total length: 600 mm

Puntale perfettamente rifinito - Perfectly finished tip

Lunghezza puntale - Tip length: 8 mm

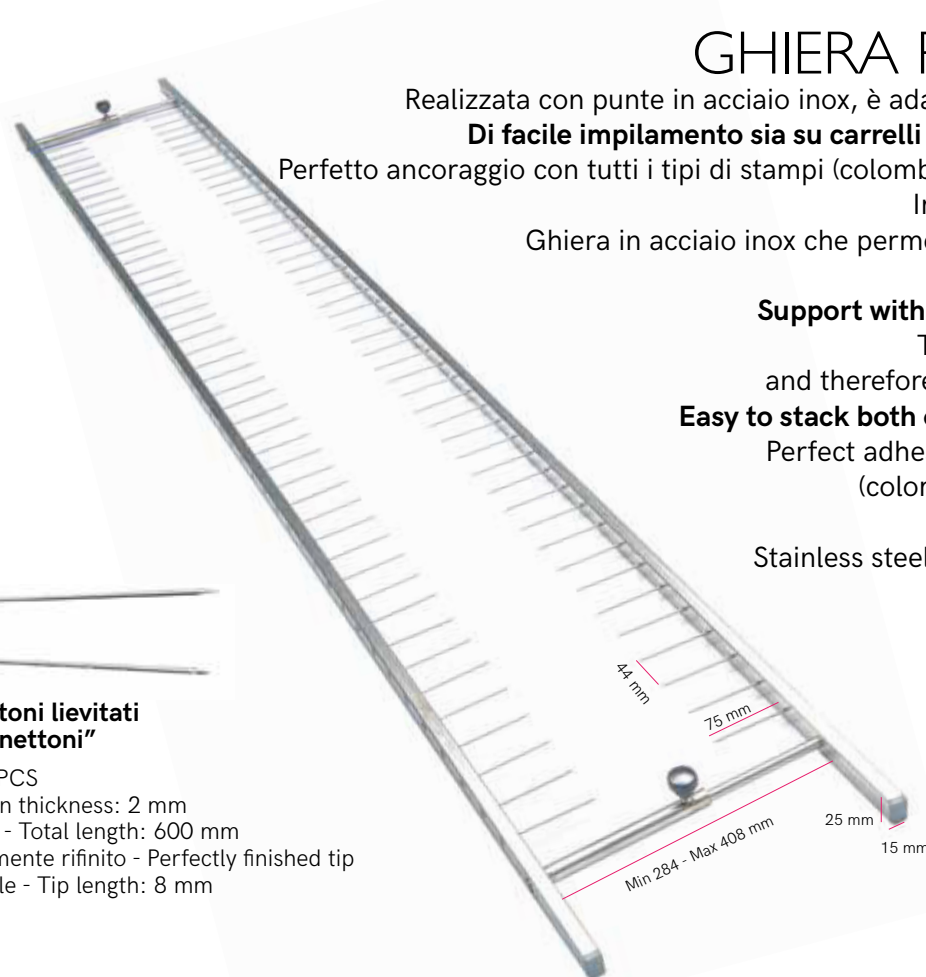

50GIRA02

Asse girapanettoni

"Panettoni" cake turning rod

Acciaio inox - Stainless steel

Lunghezza - Total size: 221 cm

Aghi fissi - fixed pins Ø2,7 mm

CLASSIC SYSTEM

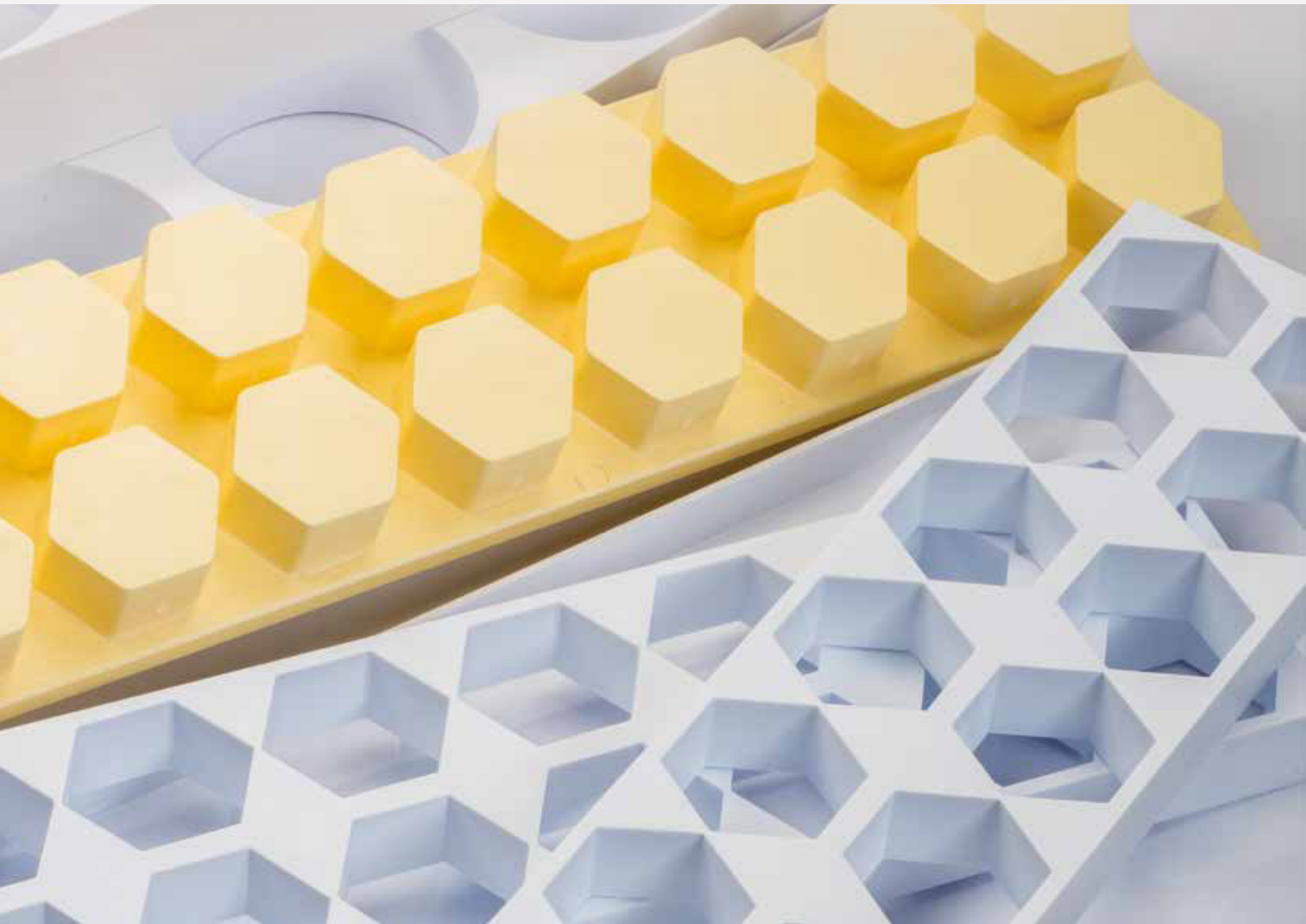

Barre in plastica per la produzione, sia dolce che salata, di monoporzioni e mignon. Il materiale rigido conferisce stabilità per una maggior precisione nella preparazione e maneggiabilità durante la lavorazione. Facili da riempire, anche senza teglia, e da spatolare per la chiusura. L'estrazione risulta facile anche con il prodotto non completamente congelato e grazie all'acetato non sarà necessario glassare.

Plastic bars for the production, both sweet and savoury, of single portions and mignons. The rigid material gives stability for greater precision in preparation and handling during processing. Easy to fill, even without baking tray, and to spatulate for closing. Extraction is easy even when the product is not completely frozen and thanks to acetate there is no need to glaze.

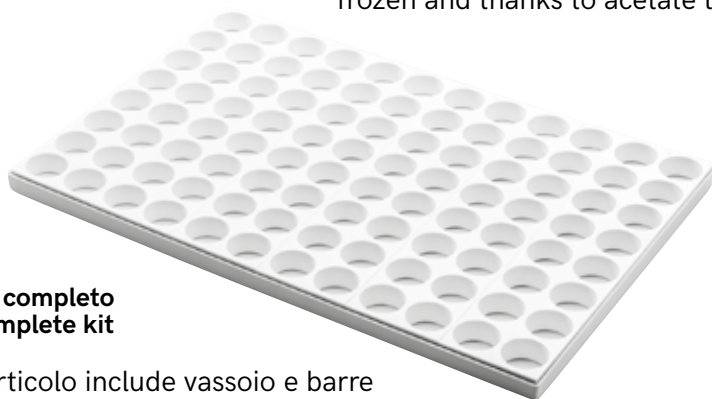

Kit completo
Complete kit

L'articolo include vassoio e barre
The article includes tray and bars



Estrattori
Extractors

Non inclusi
Not included



Tagliapasta
Cutters

Non inclusi
Not included



MIGNON

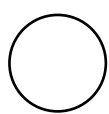

CIRCLE
Ø 42,5 h 25 mm
CAP. 23 ML

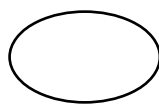

OVAL
53x32 h 25 mm
CAP. 33 ML

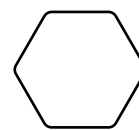

EXAGONAL
46x41 h 25 mm
CAP. 36 ML

Prod.	Codice - Code	Extractor	Cutter
32	MIGNON A001	ED 1	TPM 1
48	MIGNON B001	ED 1	TPM 1
96	MIGNON C001	ED 1	TPM 1

Prod.	Codice - Code	Extractor	Cutter
32	MIGNON A002	ED 2	TPM 2
48	MIGNON B002	ED 2	TPM 2
96	MIGNON C002	ED 2	TPM 2

Prod.	Codice - Code	Extractor	Cutter
32	MIGNON A003	ED 3	TPM 3
48	MIGNON B003	ED 3	TPM 3
96	MIGNON C003	ED 3	TPM 3

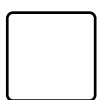

SQUARE
37x37 h 25 mm
CAP. 24 ML



HEART
48x44 h 25 mm
CAP. 35 ML

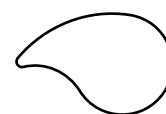

COMMA
55x35 h 25 mm
CAP. 32 ML

Prod.	Codice - Code	Extractor	Cutter
32	MIGNON A005	ED 5	TPM 5
48	MIGNON B005	ED 5	TPM 5
96	MIGNON C005	ED 5	TPM 5

Prod.	Codice - Code	Extractor	Cutter
32	MIGNON A007	ED 7	TPM 7
48	MIGNON B007	ED 7	TPM 7
96	MIGNON C007	ED 7	TPM 7

Prod.	Codice - Code	Extractor	Cutter
32	MIGNON A009	ED 9	TPM 9
48	MIGNON B009	ED 9	TPM 9
96	MIGNON C009	ED 9	TPM 9

MIGNON A
20X40CM
2 Barre/Moulds
32 mignon

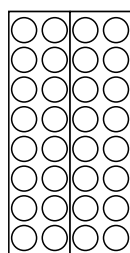

MIGNON B
30X40CM
3 Barre/Moulds
48 mignon

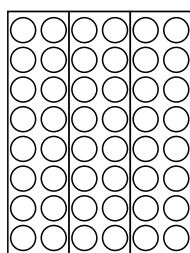

MIGNON C
60X40CM
6 Barre/Moulds
96 mignon

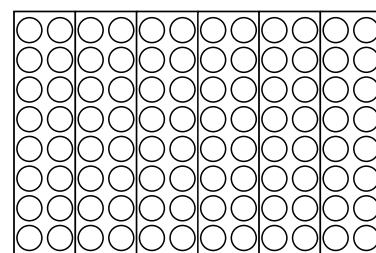



INDIVIDUAL DESSERT

MONOP. A

17X40CM

2 Barre/Moulds

10 monoportion

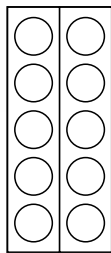

MONOP. B

26X40CM

3 Barre/Moulds

15 monoportion

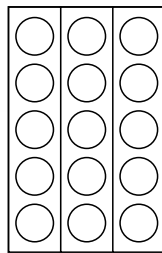

MONOP. C

60X40CM

7 Barre/Moulds

35 monoportion

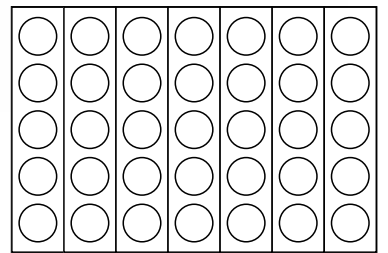

Kit completo
Complete kit

L'articolo include vassoio e barre
The article includes tray and bars



Estrattori
Extractors

Non inclusi
Not included



Tagliapasta
Cutters

Non inclusi
Not included

CIRCLE

Ø65 h.40 mm

CAP. 133 ML

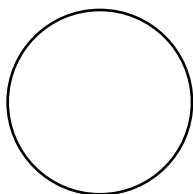

Prod.	Codice - Code	Extractor	Cutter
10	MONOP. A001	EM 1	TPG 1
15	MONOP. B001	EM 1	TPG 1
35	MONOP. C001	EM 1	TPG 1

CIRCLE

Ø60 h 45 mm

CAP. 127 ML

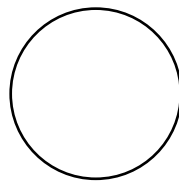

Prod.	Codice - Code	Extractor	Cutter
10	MONOP. A1	EM 01	TPG 01
15	MONOP. B1	EM 01	TPG 01
35	MONOP. C1	EM 01	TPG 01

OVAL

87x51 h 40 mm

CAP. 139 ML

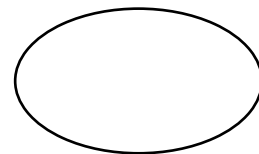

Prod.	Codice - Code	Extractor	Cutter
10	MONOP. A002	EM 2	TPG 2
15	MONOP. B002	EM 2	TPG 2
35	MONOP. C002	EM 2	TPG 2

SQUARE

59x59 h 40 mm

CAP. 139 ML

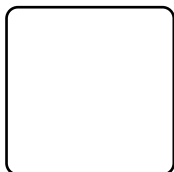

Prod.	Codice - Code	Extractor	Cutter
10	MONOP. A005	EM 5	TPG 5
15	MONOP. B005	EM 5	TPG 5
35	MONOP. C005	EM 5	TPG 5

HEART

78,5x72,5 h 40 mm

CAP. 143 ML

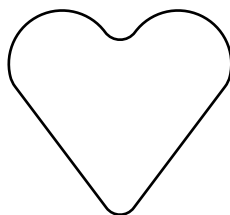

Prod.	Codice - Code	Extractor	Cutter
10	MONOP. A007	EM 7	TPG 7
15	MONOP. B007	EM 7	TPG 7
35	MONOP. C007	EM 7	TPG 7

DROP

89x57,5 h 40 mm

CAP. 138 ML

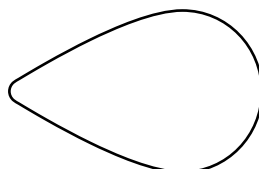

Prod.	Codice - Code	Extractor	Cutter
10	MONOP. A008	EM 8	TPG 8
15	MONOP. B008	EM 8	TPG 8
35	MONOP. C008	EM 8	TPG 8

COMMA

92x60 h 40 mm

CAP. 143 ML

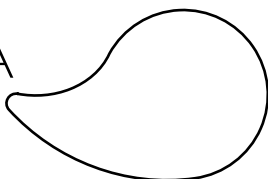

Prod.	Codice - Code	Extractor	Cutter
10	MONOP. A009	EM 9	TPG 9
15	MONOP. B009	EM 9	TPG 9
35	MONOP. C009	EM 9	TPG 9

OBLONG

94x38 h 40 mm

CAP. 130 ML



Prod.	Codice - Code	Extractor	Cutter
10	MONOP. A0013	EM 13	TPG 13
15	MONOP. B0013	EM 13	TPG 13
35	MONOP. C0013	EM 13	TPG 13



CAKE SLICE



SLICE 150 ML

117x62 h 40 mm

Prod.	Codice - Code	Extractor	Cutter
8	MONOP. A0016	EM 16	TPG 16
12	MONOP. B0016	EM 16	TPG 16
28	MONOP. C0016	EM 16	TPG 16

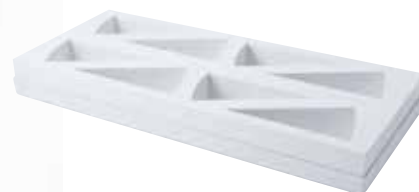

12 fette/slices = 1 torta/cake Ø24cm
L'articolo include vassoio e barre
The article includes tray and bars

SPECIAL SIZE

Stampi per monoporzioni extra size per rispondere alle esigenze di misure diverse dall'ordinario. L'articolo include vassoio 60x40 cm e 7 barre.

Moulds for extra-size single-portion to meet the needs of non-standard sizes. The item includes 60x40 cm tray and 7 bars.
Prod. 28 dolci / cake

ml	mm	h mm	Cod.	Extractor	Cutter
200	Ø 80	40	EXTRA C	EEX1	TPEX 1



Stampi per pratici mini cake biporzione adatti alle richieste delle moderne tendenze. L'articolo include vassoio 60x40 cm e 5 barre.

Moulds for practical mini double portion cakes suitable for modern trends' demands. The article includes 60x40 cm tray and 5 moulds.
Prod. 15 dolci / cake

ml	mm	h mm	Cod.	Cutter
350	Ø 100	45	MONOP. C101	TPB1



ACETATI - ACETATE

Extra trasparenti, super resistenti, prodotti con materiale di alta qualità. Facili da usare per rivestire stampi e per realizzare e sfornare monoporzioni e mignon. Antiaderenti per uso alimentare. Adatti al raffreddamento in abbattitore, congelatore e frigo, ma non adatti alla cottura.

Extra-clear, super-strong, made of high-quality material. Easy to use for coating moulds and for making and unmoulding monoportions and mignons. Non-stick for food use. Suitable for cooling in blast chillers, freezers and fridges, but not suitable for baking.

Il materiale multistrato con il quale sono realizzati i nostri nastri proviene parzialmente da plastica riciclata. La loro speciale composizione li rendono idonei al contatto alimentare e rispettosi dell'ambiente.

The multi-layer material with which our ribbons are made comes partly from recycled plastic. Their special composition makes them suitable for food contact and environment-friendly.



NASTRI - RIBBONS

80my - 305 mt

Tutti i rotoli sono adatti alla taglianastri:

MART CUTTER
AUTOMATIC RIBBON CUTTER



NSA H 25
H 25 mm



NSA H 30
H 30 mm



NSA H 35
H 35 mm



NSA H 40
H 40 mm



NSA H 45
H 45 mm



NSA H 50
H 50 mm



NSA H 55
H 55 mm



NSA H 60
H 60 mm

FOGLI CHITARRA GUITAR SHEETS



NSA60X40MO
590x390 mm
Pack 50 pcs - 120 MY

NSA39X39MO
390x390 mm
pack 100 pcs
75 MY

NSA27X27MO
270x270 mm
pack 100 pcs
75 MY
ideal for 50TLMINI

Ideali per creare decorazioni di cioccolato, trasferiscono lucentezza al prodotto finito e facilitano il distacco. Ideal for creating chocolate decorations as they transfer shine to the finished product and facilitate the detachment.

FOGLI - SHEETS

80 micron - 50 pcs



NSA300X300
300x300 mm

NSA400X600
388x588 mm

Disponibili altre misure e spessori su richiesta. Other sizes and thicknesses available on request.

STRISCE - STRIPS

90 micron - 1000 pcs



NSA30X240 h 30x240 mm
NSA40X240 h 40x240 mm

NSA25X150
h 25x150 mm

Dessert idea



La tradizione crea la modernità

Combinare gli elementi per dare vita a monoporzioni che, giocando con le proporzioni dei sapori, creano nuove armonie di gusto. Nasce con questo intento un progetto di dessert, pensato per la ristorazione, ma perfetto per la pasticceria moderna, che utilizzando semplici attrezzature consente risultati di alto livello.

Monoporzioni che accostano gusti, consistenze e colori per stimolare la voglia di assaggiare dei clienti, combinandoli a misure e forme diverse.

Tradition creates modernity

Combining the elements to give life to single portions that, playing with the proportions of flavors, create new harmonies of taste. With this intent a dessert project was born, designed for catering, but perfect for modern pastry making, which by using simple equipment allows high level results.

Monoporzioni that combine flavors, textures and colors to stimulate customers' desire to taste, combining them with different sizes and shapes.



Circle

30IDEA01

Ø83 h 25mm ~ 130ml
Prod. 12 pcs

2 barre-bars + 1 estrattore-extractor



Tagliapasta - Cutter

TPIDEA01

2 pcs - 2 sizes



Rectangle

30IDEA02

62x48 h 25mm ~ 70ml
Prod. 18 pcs

2 barre-bars + 1 estrattore-extractor



Tagliapasta - Cutter

TPIDEA02

2 pcs - 2 sizes



Log

30IDEA03

118x47 h 25mm ~ 130ml
Prod. 9 pcs

2 barre-bars + 1 estrattore-extractor



Tagliapasta - Cutter

TPIDEA03

2 pcs - 2 sizes



Triangle

30IDEA04

42x38 h 25mm ~ 25ml
Prod. 48 pcs

2 barre-bars + 1 estrattore-extractor



Dot

30IDEA05

Ø35 h 25mm ~ 25ml
Prod. 48 pcs

2 barre-bars + 1 estrattore-extractor



Square

30IDEA06

31,5x31,5 h 25mm ~ 25ml
Prod. 48 pcs

2 barre-bars + 1 estrattore-extractor

Ogni confezione comprende:
2 barre ed 1 estrattore.



EASY LOG



CLASSIC



30TT104S

400x100 - h60 mm
Plastic mould

ACCESSORIES



Fogli acetato - Acetate sheets

NSA163X360

360x163mm - 50 fogli - sheets



Stampi per inserti - Moulds for inserts

30TB3S

Kit 2 stampi plastica - 2 plastic moulds kit
35x180 h30 mm



TRIANGULAR



ST1
480x65 - h65 mm



FANCY



ST3
480x65 - h50 mm



DOME



ST2
480x65 - h50 mm

ST4
480x50 - h40 mm



Pralina Stella

MA1984

Polycarbonate mould
40x42 h16 mm
15 pcs ~ 10 gr



SEMIFREDDO MATS

360x163 mm
FOR CLASSIC MOULD

LISCIO
SMOOTH
30TS000



I tappeti in silicone sapranno arricchire i vostri tronchetti.

Il materiale rende possibile un'ottimale sformatura del semifreddo donando al dessert decori di grande effetto.

The silicone mats will enrich your log-shaped dessert.

The material features ensure easy removal of the semifreddo from the mould, creating impressive decorations.

Arabic
30TS001



FLOREAL
30TS002



O'CLOCK
30TS003



MEDIEVAL
30TS005



STONE
30TS006

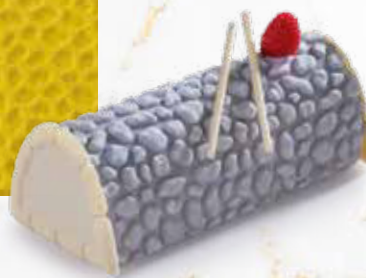

WAVES
30TS007



HOLLY
30TS008



SNOWFLAKE
30TS009



COMET
30TS010



BRICK
30TS012



QUADRI
30TS016



DECORATIONS

Arabic
20TES001



Floreal
20TES002



Flower
20TES004



Medieval
20TES005



Stone
20TES006



Waves
20TES007



Kit 2 plastic moulds to realize 12 decorations

Individual Cake

Silicone Moulds

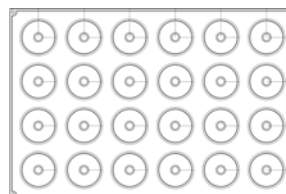

Donuts

30SILO1N

Ø75 h 25 mm - vol. ~ 90 ml
prod. 24 pcs

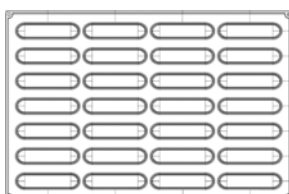

Eclair

30SILO2N

130x30 h 28 mm - vol. ~ 85 ml
prod. 28 pcs



Stampi in silicone per monoporzioni, in formato 600x400 mm per un'alta produttività.
Silicone moulds for single- portions, in a 600x400 mm format for high productivity.



+230° / -60°C
+446° / -76°F

Mould size 595x395 mm

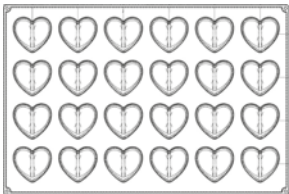

Love

30SILO3N

75x68 h 30 mm - vol. ~ 90 ml
prod. 24 pcs

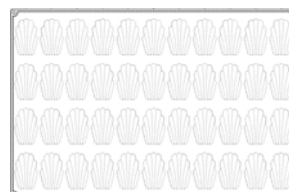
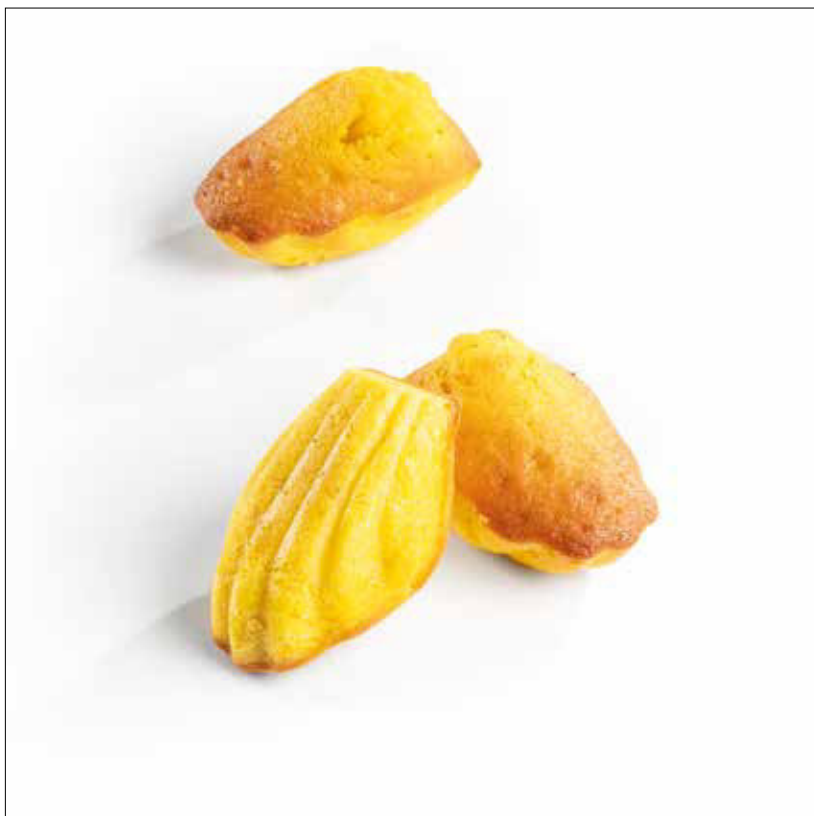

Madeleine

30SILO8N

74x45 h 18 mm - vol. ~ 35 ml
prod. 44 pcs

Individual Cake

Silicone Moulds

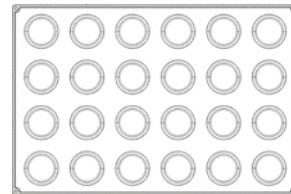

Muffin

30SILO7N

Ø69 h 39 mm - vol. ~ 120 ml
prod. 24 pcs

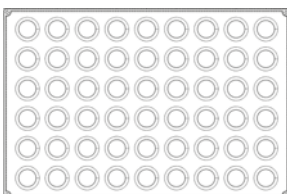

Mini Muffin

30SILO6N

Ø50 h 28 mm - vol. ~ 40 ml
prod. 54 pcs



Stampi in silicone per monoporzioni, in formato 600x400 mm per un'alta produttività.
Silicone moulds for single-portions, in a 600x400 mm format for high productivity.



+23° / -60°C
+446° / -76°F

Mould size 595x395 mm

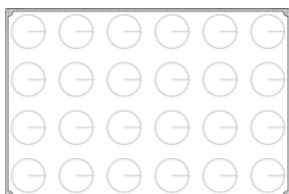

Sphere

30SILO4N

Ø70 h 35 mm - vol. ~ 90 ml
prod. 24 pcs

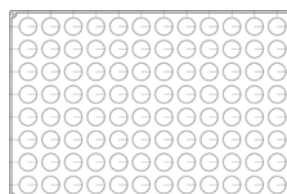

Mini Sphere

30SILO5N

Ø35 h 17,5 mm - vol. ~ 10 ml
prod. 96 pcs

Individual Cake

Silicone Moulds



HALF SPHERE
SF001
Ø 80 h 40 mm
5 fig.



HALF SPHERE
SF002
Ø 70 h 35 mm
6 fig.



HALF SPHERE
SF003
Ø 60 h 30 mm
6 fig.



HALF SPHERE
SF004
Ø 50 h 25 mm
8 fig.



HALF SPHERE
SF005
Ø 40 h 20 mm
15 fig.



HALF SPHERE
SF006
Ø 30 h 15 mm
24 fig.



HALF SPHERE
SF500
Ø 45 h 22,5 mm
15 fig.



HALF SPHERE
SF501
Ø 35 h 17,5 mm
18 fig.



HALF SPHERE
SF502
Ø 25 h 12,5 mm
28 fig.



PIRAMIDE - PYRAMID
SF007
71x71 h 40 mm
6 fig.



PIRAMIDE - PYRAMID
SF008
36x36 h 22 mm
15 fig.



POMPONETTE
SF009
Ø 34 h 16 mm
24 fig.



SAVARIN
SF010
Ø 41 h 12 mm
18 fig.



SAVARIN
SF011
Ø 65 h 21 mm
8 fig.



SAVARIN
SF012
Ø 72 h 23 mm
6 fig.



TARTELETTA - TARTLET
SF013
Ø 45 h 10 mm
15 fig.



TARTELETTA - TARTLET
SF014
Ø 50 h 15 mm
15 fig.



TARTELETTA - TARTLET
SF015
Ø 60 h 17 mm
8 fig.



TARTELETTA - TARTLET
SF016
Ø 70 h 20 mm
6 fig.



OVALI - OVAL
SF017
55x33 h 20 mm
16 fig.

Stampi in silicone alimentare antiaderente e sono adatti all'uso in abbattitore e in forno, Moulds made of non-stick food grade silicone suitable for use in blast chillers and ovens.



+230° / -60°C
+446° / -76°F

Mould size 175x300 mm



OVALI - OVAL
SF018
70x50 h 20 mm
9 fig.



BABÀ
SF019
Ø 35 h 38 mm
15 fig.



BABÀ
SF020
Ø 45 h 48 mm
11 fig.



BABÀ
SF021
Ø 55 h 60 mm
8 fig.



MUFFIN
SF022
Ø 51 h 28 mm
11 fig.



MUFFIN
SF023
Ø 69 h 35 mm
6 fig.



MUFFIN
SF024
Ø 81 h 32 mm
5 fig.



FINANZIERE
SF025
49x26 h 11 mm
20 fig.



CAKE
SF026
79x29 h 30 mm
12 fig.



PETITE FOUR
SF027
Ø40 h 20 mm
15 fig.



CILINDRO - CYLINDER
SF028
Ø60 h 35 mm
8 fig.



FIorentINE
SF029
Ø60 h 12 mm
8 fig.



FIorentINE
SF030
Ø35 h 5 mm
24 fig.



MADELEINE
SF031
44x34 h 10 mm
15 fig.



MADELEINE
SF032
68x45 h 17 mm
9 fig.



BORDELAIS
SF033
Ø35 h 35 mm
18 fig.



BRIOCHETTE
SF034
Ø76 h 37 mm
6 fig.



BRIOCHETTE
SF035
Ø79 h 30 mm
6 fig.



CUORE - HEART
SF036
Ø65 h 60 mm
6 fig.



OTTAGONO - OCTAGON
SF037
Ø38 h 26 mm
15 fig.

Individual Cake

Silicone Moulds



BARCETTA - BOAT
SF038
72x30 h 15 mm
12 fig.



BARCETTA - BOAT
SF039
100x44 h 15 mm
9 fig.



CUORE - HEART
SF040
Ø60 h 35 mm
8 fig.



HALF EGG
SF041
102x73 h 36 mm
5 fig.



DISCO - SPONGE BASE
SF042
Ø100 h 20 mm
3 fig.



TORTINA - FLAN
SF043
Ø40 h 13 mm
15 fig.



TORTINA - FLAN
SF044
Ø50 h 14 mm
15 fig.



TORTINA - FLAN
SF045
Ø60 h 17 mm
8 fig.



TORTINA - FLAN
SF046
Ø70 h 17 mm
6 fig.



TORTINA - FLAN
SF047
Ø80 h 18 mm
6 fig.



DIAMANTE - DIAMOND
SF048
Ø35 h 23 mm
18 fig.



DIAMANTE - DIAMOND
SF049
Ø68 h 45 mm
6 fig.



BORDELAIS
SF050
Ø55 h 50 mm
8 fig.



BAVARESE
SF051
Ø57 h 57 mm
8 fig.



MUFFIN
SF052
Ø75 h 60 mm
6 fig.



KRAPFEN
SF053
Ø60 h 20 mm
6 fig.



FINANZIERE
SF054
95x45 h 12 mm
7 fig.



OVALI - OVAL
SF055
75x55 h 35 mm
8 fig.



MARGUERITE
SF056
Ø70 h 28 mm
6 fig.



GUGELHOPF
SF057
Ø55 h 36 mm
8 fig.

Stampi in silicone alimentare antiaderente e sono adatti all'uso in abbattitore e in forno, Moulds made of non-stick food grade silicone suitable for use in blast chillers and ovens.



+230° / -60°C
+446° / -76°F

Mould size 175x300 mm



GUGELHOPF
SF058
Ø70 h 36 mm
6 fig.



BORDELAIS
SF059
Ø45 h 45 mm
18 fig.



TORRONCINI - NOUGAT
SF060
50x25 h 20 mm
20 fig.



MIX
SF061
Ø75 h 40 mm
2x3 fig.



MUFFIN GRANDE
SF102
Ø68 h 38 mm
6 fig.



SAVOIARDO
SF103
127,5x47 h 17 mm
6 fig.



MINI BRIOCHETTE
SF109
Ø58 h 22 mm
6 fig.



MARSIGLIESE
SF114
95x35 h 25 mm
7 fig.



WAFFLE CLASSIC
SF155
130x81 h 17mm
4 fig.



ÉCLAIR
SF161
125x28 h 5mm
8 fig.



MINI CAKE SQUARE
SF168
69x69 h 60mm
6 fig.



DONUTS
SF170
Ø75/25 h28 mm
6 fig.



PASTILLE
SF180
Ø27 h11 mm
40 fig.

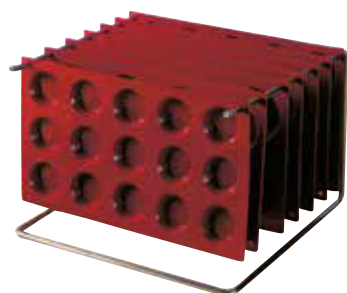

Sostegno per teglie - Support to tray

DRIP

In acciaio inox per sgocciolare le teglie.
Stainless steel support to leave the tray dry.

Baking Pan

Silicone Moulds

Stampi in silicone alimentare antiaderente e sono adatti all'uso in abbattitore e in forno, Moulds made of non-stick food grade silicone suitable for use in blast chillers and ovens.



+230° / -60°C
+446° / -76°F



CUORE - HEART

SFT 210/Y
220x218 h 40 mm



MARGUERITE

SFT 220/Y
Ø220 h 45 mm



CIAMBELLA - SAVARIN

SFT 224/Y
Ø240 h 60 mm



GUGELHOPF

SFT 250/Y
Ø220 h 110 mm



ROSA - ROSE

SFT 251/Y
Ø220 h 100 mm



RECTANGULAR

SFT 300/Y
280x220 h 40 mm



BRIOCHE

SFT 522/Y
Ø220 h 80 mm



STAR BUNDT

SFT 600/Y
Ø240 h 100 mm



PLUM CAKE

SFT 730/Y
300x145 h 80 mm



PLUM CAKE

SFT 326/Y
240x105 h 65 mm



PLUM CAKE

SFT 330/Y
260x100 h 70 mm



CROSTATATA - FLAN PAN

SFT 424/Y
Ø240 h 30 mm

SFT 426/Y
Ø260 h 30 mm

SFT 428/Y
Ø280 h 30 mm



TONDO - ROUND

SFT 118/Y
Ø180 h 40 mm

SFT 120/Y
Ø200 h 40 mm

SFT 122/Y
Ø220 h 42 mm

SFT 124/Y
Ø240 h 42 mm

SFT 1205/Y
Ø200 h 50 mm

SFT 126/Y
Ø260 h 45 mm

SFT 128/Y
Ø280 h 47 mm



Stampi per gelatine, in puro silicone alimentare,
per la realizzazione di gelatine alla frutta, fondenti, ecc.
Cornice in plastica.

Jelly moulds, in pure food-grade silicone, for making fruit jellies,
fondants, etc. Plastic frame.



**FETTA ARANCIA
ORANGE SLICE**

SG 01

Size:45x18 h 15 mm
24 fig.



**CUORE
HEART**

SG 03

Size:34x30 h 18 mm
24 fig.



**ANANAS
PINEAPPLE**

SG 07

Size:33x23 h 18 mm
24 fig.



**FRAGOLA
STRAWBERRY**

SG 08

Size:36x30 h 20 mm
24 fig.



**PESCA
PEACH**

SG 09

Size:35x25 h 20 mm
24 fig.



**MORA
BERRY**

SG 06

Size:Ø30 h 24 mm
24 fig.



**SEMISFERE
HALFSPHERE**

SG 04

Size:Ø27 h 13,5 mm
24 fig.



**PERA
PEAR**

SG 02

Size:40x26 h 15 mm
24 fig.



**BON BON
PASTILLE**

SG 05

Size:Ø30 h 11 mm
24 fig.

Stampo - Mould: 180x335 mm

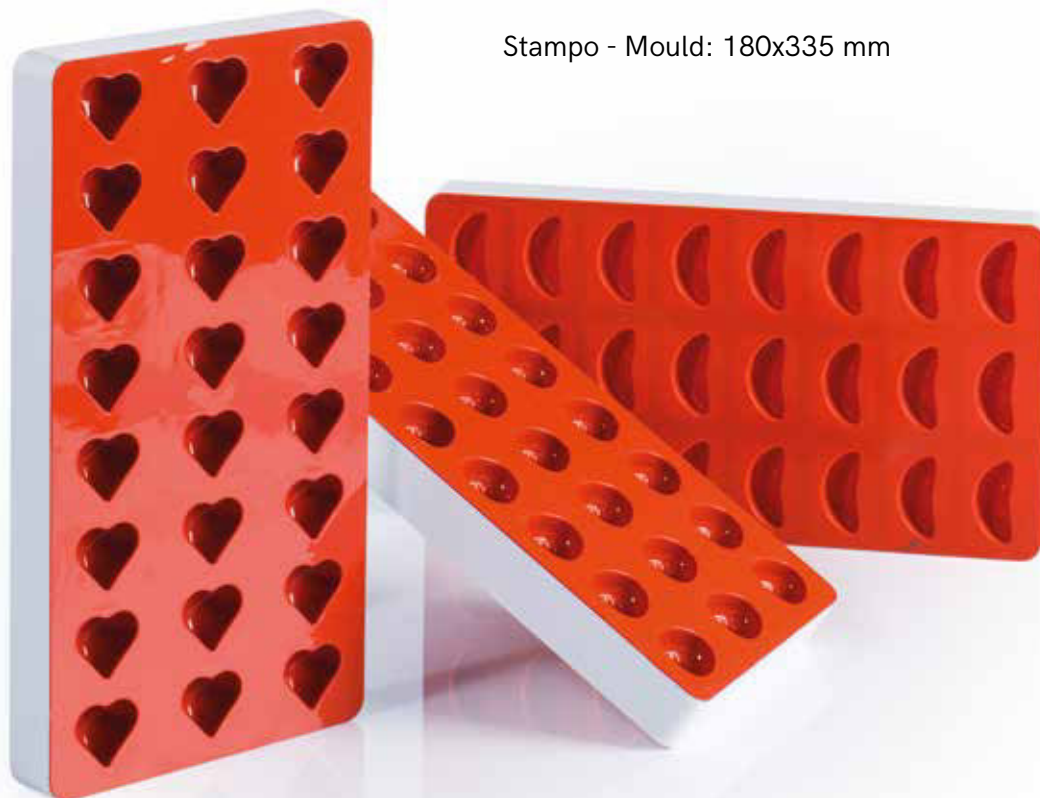

Eclair

MANIA



TAPPETI SILICONE SILICONE MATS

Eclair 25x125mm

30TE6001R

58,5x38,6 cm - 36 pcs

30TE3001R

29,8x39,8 cm - 18 pcs

Mini Eclair 18x60mm

30TE6002R

58,5x38,6 cm - 70 pcs

30TE3002R

29,8x39,8 cm - 35 pcs



STAMPI PER DECORAZIONI DI CIOCCOLATO MOULDS FOR CHOCOLATE DECORATIONS

Eclair 25x125mm

20EC01

Kit 6 stamper / moulds
prod 36 pcs

Mini Eclair 18x60mm

20EC02

Kit 6 stamper / moulds
prod 72 pcs



TAGLIAPASTA PER DECORAZIONI PASTRY CUTTER FOR DECORATIONS

Eclair 25x125mm

31CUT01

Mini Eclair 18x60mm

31CUT02

Macaron

MANIA



TAPPETI SILICONE SILICONE MATS

Macaron Ø40mm

30TM6001R

58,5x38,6 cm
70 gusci/shells

Macaron Ø40mm

30TM3001R

30x40cm
34 gusci/shells



DIME / TEMPLATE

Il prodotto va posizionato su foglio di carta da forno, la cui trasparenza permette di vedere dove posizionare l'impasto di Eclair / Macaron, e sfilato prima della cottura.

Non adatto alla cottura

The product must be placed on a sheet of baking paper, whose transparency allows to see where to place the mixture of Eclair / Macaron, and removed before baking.

Not suitable for cooking

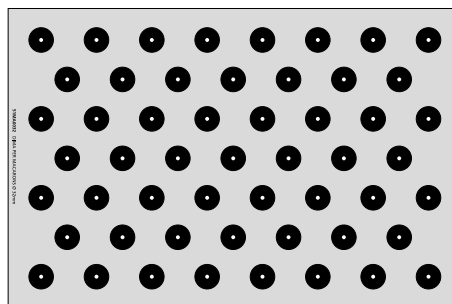

Macaron Ø32mm

51MA0032

Dima in plastica - Plastic template 59x39 cm
Prod. 53 gusci/shells

ICE CREAM

Ice Tube

Lo stampo best seller per rinfrescare l'estate. Con Icetube si ottengono splendidi ghiaccioli da esporre in vetrina per ingolosire i clienti e da consegnare loro come contenitore.

Riutilizzabili e lavabili in lavastoviglie: 50 lavaggi, 100 % riciclabile, BPA free

The best seller mould to refresh the summer. With Icetube you can obtain wonderful icicles to display in the window to tempt customers and to give them as a container.

Reusable and dishwasher safe: 50 washes, 100% recyclable, BPA free.





Ice tube

CLP01

100 pcs ~150 ml
 Ø53 x 174 mm

— PLEXIGLASS DISPLAYS —



Supporto plastica bianca per abbattitore
White plastic holder for blast chiller

CLPESPOB

290x390 h120 mm
 28 sedi - holes



Espositore trasparente vetrina verticale
Transparent display for vertical cabinets

CLPESPOBTRA

280x360 h120 mm
 25 sedi - holes



Espositori satinati per vetrina gelato
Satin-finish displays for standard ice-cream

CLPESPO21

250x360 h45 mm
 21 sedi - holes

CLPESPO15

160x360 h45 mm
 15 sedi - holes

STECCO MOULDS



Stampo in **silicone alimentare** per dolci da passeggio a forma di lingotto. Proposto con due diverse grammature consente di produrre **gelati e mini snack**, ricoperti per diventare ancora più golosi.

Food grade silicone mould for walking gelato in the shape of an ingot. Proposed with two different weights allows you to produce **ice cream and mini snacks**, that once covered become even more delicious.



BRICK

104002

Ice cream: 35 x 25 h 93 mm
 Prod. 12 pcs - Weight ~ 74 ml
 2 Stampi/moulds 390 x 146 mm
 Vassoio/tray 410 x 305 mm
 50 Bastoncini/sticks



DISPLAY

Plexiglass display

10E007
 370x230 h 50 mm - Cap. 24 pcs
 Ideal for Brick

10E006
 370x235 h 39 mm - Cap. 40/48 pcs
 Ideal for Brick Mini



BRICK MINI

104003

Ice cream: 26,5 x 21 h 70 mm
 Prod. 16 pcs - Weight ~ 35 ml
 2 Stampi/moulds 390 x 118 mm
 Vassoio/tray 410 x 255 mm
 50 Bastoncini/sticks



STICKS

Wooden sticks

10SL114
 9,5 h 114 mm - 500 pcs
 Ideal for Brick

10SL072
 8 h 72 mm - 500 pcs
 Ideal for Brick Mini

STECCO MOULDS



Lo **stampo in silicone** perfetto per realizzare **ricoperti o semplici gelati su stecco**.
La sua forma classica e lineare consente di creare infinite proposte, sia dolci che salate.

Classic **silicone mould** to prepare **covered or simple ice creams on a stick**.
Its linear shape allows to create endless proposals, both sweet and savory.



CLASSIC

104000

Ice-cream: 44x22 h 93 mm
Prod: 12 pcs - 80 ml

2 Stampi/Moulds 390x146 mm
Vassoio/Tray 410x310 mm
50 Bastoncini/Sticks



DISPLAY

Plexiglass display

10E007

370x230 h 50 mm - Cap. 24 pcs
Ideal for Classic

10E006

370x235 h 39 mm - Cap. 40/48 pcs
Ideal for Classic Mini

CLASSIC MINI

104001

Ice-cream: 33x18 h 69 mm
Prod: 16 pcs - 35 ml

2 Stampi/Moulds 390x118 mm
Vassoio/Tray 410x255 mm
50 Bastoncini/Sticks



STICKS

Wooden sticks

10SL114

9,5 h 114 mm - 500 pcs
Ideal for Classic

10SL072

8 h 72 mm - 500 pcs
Ideal for Classic Mini

GhiaccioloFlex

La rivoluzione dedicata alla produzione artigianale di ghiaccioli su stecco. Lo straordinario materiale plastico utilizzato per la sua produzione lo rende particolarmente flessibile e assolutamente indeformabile.

The revolution dedicated to the artisan production of ice lollies on stick. The extraordinary plastic material selected and used for its production makes it absolutely non-deformable and particularly flexible.





Heart
105001
90 ml
 42x40 h 102 mm
 Prod: 24 pcs ~ 80/85 gr



Recouvert
105002
90 ml
 56x33 h 102 mm
 Prod: 24 pcs ~ 80/85 gr



Twig
105003
90 ml
 Ø35 h 100 mm
 Prod: 24 pcs ~ 80/85 gr



Wave
105000
86 ml
 49x22 h 125 mm
 Prod: 24 pcs ~ 80/85 gr

PLEXIGLASS DISPLAYS

Espositore in plexiglass per vetrina orizzontale
Plexiglass display for horizontal showcases

10-E002
 Misura - Size: 360x250 h50mm
 Cap. 24 pcs

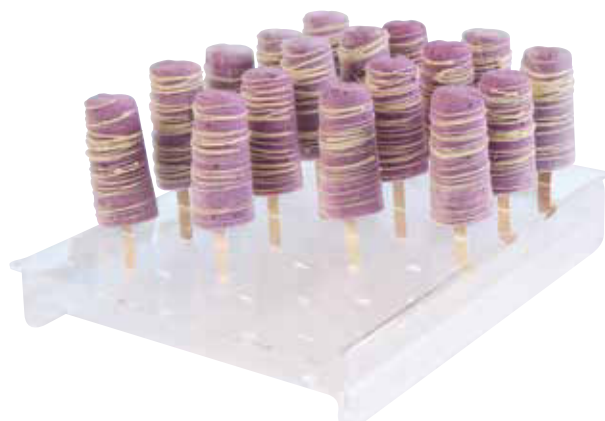

Baby Ice®

Un ottimale connubio di simpatia delle forme e genuinità degli ingredienti che solo la vera produzione artigianale può offrire. Grazie agli stampi in plastica a forma di animali si potranno produrre coloratissimi e freschissimi ghiaccioli. Lavabili in lavastoviglie e riutilizzabili.

The perfect mix of funny shapes and genuine ingredients that can be provided only by artisan production. A kit of plastic moulds to produce colorful and fresh animal shaped ice lollies. Reusable and dishwasher safe.



Cow x10 pcs
65x33 h90mm



Bear x10 pcs
66x28 h87mm



Cat x10 pcs
61x35 h89mm



Mouse x10 pcs
60x35 h80mm



Dog x10 pcs
74x29 h90mm



Pig x10 pcs
53x37 h87mm



Hippo x10 pcs
68x31 h95mm



Chick x10 pcs
85x33 h90mm

SBIKIT01

80 pcs (8 mod.x10 pcs)
bastoncini inclusi - stick included

BST100

Sticks 100 pcs (mix)



PLEXIGLASS DISPLAYS



Espositore per vetrina orizzontale
Display for horizontal showcases

ESPICE14

Size: 160x360 h35 mm
Cap. 14 pcs



L'equilibrato mix di caratteristiche che rendono questo prodotto unico nel suo genere sono: funzionalità, praticità, eleganza e versatilità. Lo stampo, dopo la produzione, diventa un sistema di esposizione in vetrina o negli eleganti banchetti. Ideale per la realizzazione di dolci semifreddi o stuzzicanti aperitivi. Lavabili in lavastoviglie e riutilizzabili.

The balanced mix of features that make this product unique are: functionality, practicality, elegance and versatility. After production, the mould becomes a display system in the showcase or in elegant banquets. Ideal for making semifreddo desserts or tasty appetizers. Reusable and dishwasher safe.



Tondi - Rounds
GST01
 100 pcs
 Ø40 h 188mm ~ 90ml



MINI Tondi - Rounds
GST10
 100 pcs
 Ø35 h 196mm ~ 50ml

PUSH UP POPS DISPLAYS



Supporto plastica bianca per abbattitore
White plastic holder for blast chiller
GSTESPOB
 310x400 h90 mm
 28 sedi - holes

Supporto plastica bianca per abbattitore
White plastic holder for blast chiller
GSTESPOBM40
 310x400 h90 mm
 40 sedi - holes

PLEXIGLASS DISPLAY



Portaconi piccoli
Small ice cream holders
AG09002
 Cap. 27 pcs
 Misure-Size: 350x140 h52 mm
 fori-Holes: Ø18mm

Portaconi piccoli
Small ice cream holders
AG09003
 Cap. 45 pcs
 Misure-Size: 350x223 h52 mm
 fori-Holes: Ø18mm

"Eclair"



Coppetta/Cup

PMOCL001

137 X 37 h 41 mm - cap. 120 ml

Coperchio/Lid

PMOCL001C

**Tagliapasta
Eclair 25x125mm**

31CUT01



"Bucket"



Coppetta/Cup

PMOTO005

Ø78 H 57 MM - CAP. 210 ML

Coperchio/Lid

PMOTO005/C

**Tagliapasta
Bucket Ø78mm**

31CUT03



Black & White

IL TUO STILE IN VETRINA
YOUR STYLE IN THE SHOP WINDOW



vaschette porta gelato, conferiscono un tocco di modernità all'interno delle gelaterie.

Le nuove vaschette in plastica bianca o nera sono un'originale alternativa all'acciaio e danno risalto ai colori del gelato. Possono essere personalizzate con il vostro logo, sono resistenti agli urti e sono lavabili in lavastoviglie.

ice cream basins, to give a touch of modernity inside the ice cream parlors.

The new white and black plastic basins are an original alternative to steel and they will emphasize the colors of ice cream. They can be customized with your logo, are shock resistant and dishwasher safe.



Bianco - White
AG36258POLB
25x36 - h8 cm - 3,6 L

Nero - Black
AG36258POLN
25x36 - h8 cm - 3,6 L



Bianco - White
AG362512POLB
25x36 - h12 cm - 5,8 L

Nero - Black
AG362512POLN
25x36 - h12 cm - 5,8 L

personalizzabili con logo
customizable with logo

LIGHT ICE CREAM BASINS

Vaschette e coperchi in plastica leggera per vetrine gelato orizzontali
Light plastic icecream basin and leads for ice-cream horizontal showcases



5 L - Vaschetta - Ice cream basin (PST)
360x165x h120 mm

10VP1201

10VP1202

Pack 90 pcs - 70 gr

Pack 90 pcs - 90 gr



**Coperchio trasparente
Transparent lid (PET)**

AGCOP2

360X165 mm x h70 mm - Pack 180 pcs



**Coperchio piatto trasp.
Transp. flat lid (PET)**

AGCOP1

360X165 x h15 mm - Pack 180 pcs



6,5 L - Vaschetta - Ice cream basin (PST)
360x250x h80 mm - Pack 80 pcs

10VP0801

10VP0802

Pack 80 pcs - 70 gr

Pack 80 pcs - 90 gr



**Coperchio trasparente
Transparent lid (PET)**

AGCOP3

360X250 x h70mm - Pack 100 pcs



6 L - Vaschetta carapina monouso
Ø200x245 mm - Pack 66 pcs

AG20245MO

Coperchio/Lid

AGECMO

Pack 132 pcs

ICE CREAM SPATULAS

Una linea completa di spatole per dare un tocco di colore alle vetrine gelato. Disponibili in 7 differenti colori, nelle versioni classica o per carapina, le spatole Martellato sono interamente made in Italy. I materiali sono di alta qualità: cucchiaio in acciaio inox e manico ergonomico in plastica, personalizzabile su richiesta con scritte e loghi.

A complete line of spatulas to give a touch of color to the ice cream display cases. Available in 7 different colors, in classic or carapina versions, Martellato spatulas are entirely made in Italy. The materials are of high quality: stainless steel spoon and ergonomic plastic handle, customizable on request with lettering and logos.



Super confort, con impugnatura ergonomica.
Super comfort, with ergonomic handle.

CLASSIC

Lunghezza totale/ Total length: 26cm
Manico/ Handle: 13cm

10SG00	10SG01	10SG02	10SG03	10SG04	10SG05	10SG06	10SG07	10SG100
Trasparente Transparent	Bianco White	Lilla Lilac	Rosa Pink	Azzurro Sky Blue	Verde Green	Giallo Yellow	Nero Black	Finto legno Wood-like

CARAPINA

Lunghezza totale/ Total length: 20cm
Manico/ Handle: 10cm



Trasparente Transparent	Bianco White	Lilla Lilac	Rosa Pink	Azzurro Sky Blue	Verde Green	Giallo Yellow	Nero Black	Finto legno Wood-like
10SGC00	10SGC01	10SGC02	10SGC03	10SGC04	10SGC05	10SGC06	10SGC07	10SGC100

FLUO



SGM00
Trasparente
Transparent

Lunghezza totale/ Total length: 27cm
Manico/ Handle: 14cm



SGM001
Arancio - Orange



SGM002
Blu - Blue



SGM003
Bianco - White



SGM004
Giallo - Yellow



SGM007
Rosa - Pink



SGM008
Rosso - Red



SGM009
Verde - Green



SGM100
Finto legno
Wood-like

PORZIONATORI ICE CREAM SCOOPS



Ideali per realizzare palline di gelato di diverse dimensioni e grammature. I porzionatori a molla Martellato sono realizzati in acciaio inox e presentano un pratico manico rivestito in plastica isolante.

Ideal for making ice cream balls of different sizes and weights. The Martellato spring-loaded portioners are made of stainless steel and feature a practical handle covered in insulating plastic.

1/65 Lt	1/40 Lt	1/30 Lt	1/24 Lt	1/20 Lt
Ø 38 mm	Ø 44 mm	Ø 48 mm	Ø 50 mm	Ø 57 mm
10PG01	10PG02	10PG03	10PG04	10PG05

CUCCHIAI SPOONS



I cucchiaini in alluminio ultraleggero consentono una perfetta maneggiabilità.

The ultralight aluminum spoons allow perfect handling.

Cap. 30 gr	Cap. 42 gr	Cap. 60 gr	Cap. 70 gr
10CG01	10CG02	10CG03	10CG04

SEGNAGUSTO FLAVOUR MARKER

IMMERSIONE - IMMERSION

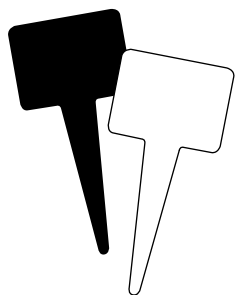

180x84 mm - plexiglass

10SI002B
pack 10 pcs colore bianco

10SI002N
pack 10 pcs colore nero

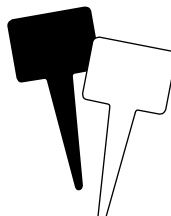

150x70 mm - plexiglass

10SI001B
pack 10 pcs colore bianco

10SI001N
pack 10 pcs colore nero



Supporti in plastica per segnagusto
Plastic supports for ice-cream flavour

10SEG

Cartellini non inclusi - Labels not included.

kit 10 pcs - h 19 cm



kit 30 pcs

10SEG05

kit 30 inserti neutri per segnagusto 10SEG
(supporti in plastica non inclusi)

kit 30 neutral inserts for plastic support 10SEG
(plastic supports not included)



APPOGGIO - FREE-STANDING

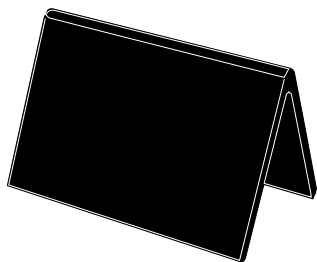

10SA001N

FREE STANDING
85 h 50,5 mm - plexiglass
pack 10 pcs colore nero

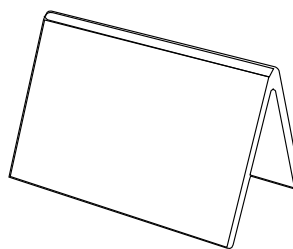

10SA001B

FREE STANDING
85 h 50,5 mm - plexiglass
pack 10 pcs colore bianco



Porta cartellino in plastica
Transparent plastic marker holder

10SEGB

Misure - Size: 87x52mm
Cartellini non inclusi - Labels not included.
kit 10 pcs



kit 30 pcs

10SEG06

kit 30 inserti neutri per segnagusto 10SEGB
(supporti in plastica non inclusi)
kit 30 neutral inserts for plastic support 10SEGB
(plastic supports not included)

raschietti - scrapers

RTRA1-5

Set 5 raschietti decorativi misti - Set composed of 5 different decorative scrapers
Misura - Size 14,5x15cm

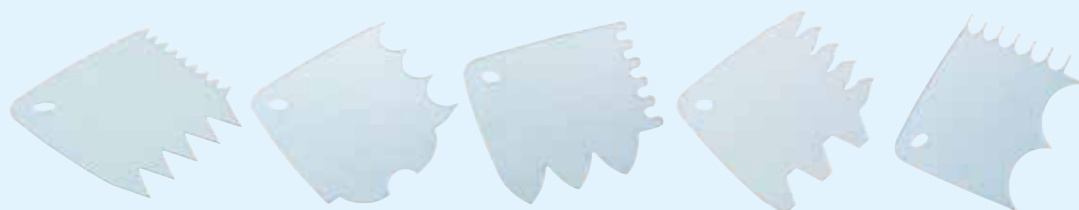

DeepMeltinchoc

MADE IN ITALY

Scioglitore a secco pensato per le gelaterie, grazie alla sua forma e dimensione è ideale per coperture in cioccolato di gelati e semifreddi su stecco. Presentato con colorazione classica, che ricorda i toni del cioccolato per adattarsi ad ogni tipologia di arredo e per essere utilizzato direttamente sul banco. Le caratteristiche tecniche del scioglitore analogici, tra cui il termostato che consente di regolare la temperatura e la vasca estraibile in alluminio anodizzato per una più facile pulizia, fanno di DEEP-MELTINCHOC un articolo essenziale.

Dry melter designed for ice cream parlours, thanks to its shape and size it is ideal for chocolate coatings of ice creams and semifreddi on sticks. Presented with the classical colour that recalls chocolate to be adaptable to any type of environment and to be used straight on the counter. The technical features of the analogical melter, including the thermostat that allows the temperature to be adjusted and the removable anodised aluminium tank for easier cleaning, make DEEP-MELTINCHOC an essential item.



Scocca, coperchio e fondo in resistente materiale plastico
Body, lid and bottom in durable plastic material

1,7 L

Deep Meltinchoc

MC10

Ø20,5 h21,2 cm



Vaschetta - Basin

MC001001

Vasca estraibile in alluminio anodizzato
Removable basin in anodized aluminum
Ø14 h18 cm

PLEXIGLASS ACCESSORIES





Porta conì 6 sedi con porta cucchiaini
Cones holder 6 holes with spoons holder

AG00930

25,5x18cm - h60,5cm
 foro superiore/upper hole 3,5 cm - inferiore/lower 2 cm
 cassetto inferiore estraibile/removable lower drawer



Porta conì 12 sedi
Cones holder 12 holes

AG00908 (nero)

Base 33x25 h50cm - Int. Ø5,2cm
 foro superiore/upper hole 3,5 cm - inferiore/lower hole 2 cm

- AG00908
- AG00902
- AG00903
- AG00904
- AG00906
Satinato/Glazed



Porta conì Girevole 18 sedi
Revolving cone holder 18 holes

AG00708N (nero)

Base Ø32 h60cm
 foro superiore/upper hole 3,5 cm
 inferiore/lower hole 2 cm

- AG00708
- AG00702
- AG00703
- AG00704
- AG00706
Satinato/Glazed



Reggi cono da banco 4 sedi
Counter top cone holder 4 holes

AG00208N (nero)

19x19cm - h24cm (Fori/Holes Ø3,5cm)

- AG00208N
- AG00202N
- AG00203N
- AG00204N
- AG00206N
Satinato/Glazed



Contenitore multiuso
Multipurpose container

AG01720 17,5x27 h31 cm

AG01710 12,5x18 h20,5 cm



Reggi cono da banco satinato 3 sedi
Counter top cone holder 3 holes satin-finish

AG03206

21x9 h11cm - 3 fori / holes Ø3,5cm

Reggi cono da banco satinato 4 sedi
Counter top cone holder 4 holes satin-finish

AG03306

28,5x9 h11cm - 4 fori / holes Ø3,5cm

PLEXIGLASS ACCESSORIES



Contenitore porta palette
Spons container

AG00606
22X26 h 21cm



Contenitore porta palette
Spons container

AG01701 18,5x30 h19cm
AG01801 17x26 h16cm



Porta palette e coppette
Spons and cups container

AG05301
28x25cm - h55cm



Porta coppette 3 scomparti
Cups holder 3 compartments

AG00501
30,5x11,5cm - h30 cm







Barattoli con coperchio - Jars with lids

AG07001 ø12 h 8 cm
AG07101 ø10 h15 cm
AG07201 ø12 h15 cm
AG07301 ø15 h15 cm
AG07401 ø18 h15 cm



TRIPLE da banco - table top
3 file - dispenser

DC32501 (transparent)
42X30 h58 - cilindro/cylinder h25 cm cap. 7,5 lt
*3 cassetti inclusi/3 drawers included 10-20-40 g

-  **DC32501**
transparent
-  **DC32508**
-  **DC32500**
-  **DC32504**

SPECIAL EQUIPMENT

artellato



GIUSEPPE
GAGLIARDI
MAESTRO
PASTICCERE

LEVEL

BISCUIT & MORE

STRATIFICAZIONE PERFETTA

Level: stendi impasto su ruote maneggevole e pratico che permette di creare rapidamente strati precisi ed uniformi, anche negli spessori più sottili. Facilita e velocizza la stesura uniforme di biscuit, pan di spagna, cioccolato e prodotti simili, scorrendo su diverse superfici, come carta forno o tappeti in silicone.

Level è progettato per razionalizzare la produzione: velocizza i tempi, semplifica i passaggi e riduce i costi.

PERFECT LAYERING

Level: handy and practical wheel-mounted dough spreader that allows you to quickly create precise and regular layers, even in the thinnest thicknesses. It facilitates and speeds up the uniform spreading of biscuit, sponge cakes, chocolate and similar products, sliding on different surfaces, such as baking paper and silicone mats.

Level is designed to rationalise production: it speeds up times, simplifies steps and reduces costs.

“Level è uno strumento che ho pensato per tutti coloro che come me cercano precisione e funzionalità, per creare prodotti perfetti.”

“Level is a tool that I have designed for all those who, like me, are looking for precision and functionality to create perfect products.”

Level

50LE001

Stendi impasto
in acciaio inox.
Dough spreader
stainless steel.



CARATTERISTICHE TECNICHE

Completamente in acciaio inox

Scala graduata millimetrica

Manopole di regolazione

Ruote direzionali per scorrimento veloce

Parete mobile per regolazione spessore

Divisori interni per regolare il flusso

Kit accessori per regolazione precisa degli spessori sottili

Capacità max 12 lt

Peso: 4,3 kg

Misura totale: 480x200 h200 mm

Larghezza apertura: 380 mm

TECHNICAL FEATURES

Made entirely of stainless steel

Millimetric graduated scale

Adjustment knobs

Directional wheels for fast sliding

Movable wall for thickness adjustment

Internal dividers for flow adjustment

Accessory kit for precise adjustment of thin shims

Maximum capacity 12 litres

Weight: 4,3 kg

Total size: 480x200 h200 mm

Slot width: 380 mm

MADE IN ITALY





Guarda il video
nel canale YouTube
di Martellato.

Watch the video
on Martellato's
YouTube channel.

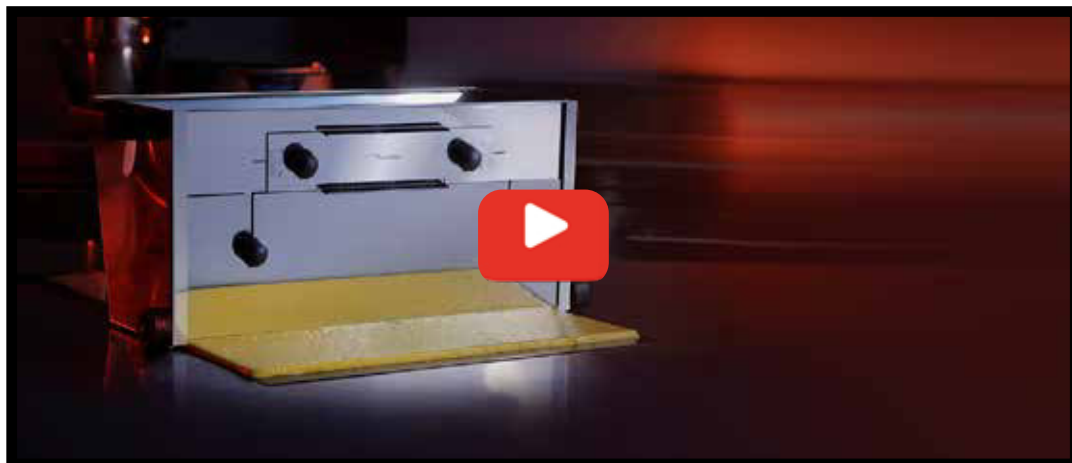

THERMAL

WARMING PLATE

Piastra elettrica riscaldante con piano in vetro temperato idoneo al contatto alimentare, ideale nella lavorazione del cioccolato. E' inoltre perfetta per riscaldare e mantenere caldi i cibi, risultando la soluzione **adatta ai buffet di catering, alberghi e ristoranti**. L'apparecchiatura è composta da una robusta struttura metallo, con fondo riscaldante, il piano in vetro temperato, il termostato per la regolazione della temperatura e piedini antiscivolo per garantire **stabilità e sicurezza** anche durante il funzionamento.

Facile da trasportare, grazie al design compatto ed al peso ridotto, e facile da pulire con un panno morbido e umido.

Caratteristiche principali:

Struttura in metallo

Superficie in vetro temperato

Range temperatura: 30°C - 85°C

Spia luminosa di funzionamento

Potenza 260 W

Peso: 2.5 Kg

Electric warming plate with a tempered glass top suitable for food contact, ideal for working with chocolate. Perfect for heating and keeping food warm, it also represents the **solution for catering buffets, hotels and restaurants**. The equipment has a strong metal structure provided with a heating base, a tempered glass top, a thermostat for temperature regulation and non-slip pads to guarantee stability and safety, even during operation.

Thanks to the compact design and low weight, it is easy to carry and clean with a soft damp cloth.

Main features:

Metal construction

Tempered Glass surface

Temperature range: 30°C - 85°C

Operating indicator light

Power 260 W

Weight: 2.5 Kg



Thermal

50PR002

Warming Plate
64 x45.5 x h.7.5 cm



Su richiesta disponibili con cablaggio GB - USA - AUSTRALIA/ On request available with GB - USA - AUSTRALIA wiring



Mart cutter

50MC001

Taglianastri automatico
Automatic ribbon cutter

Dimensioni macchina chiusa/closed machine
dimensions: 250 x 175 h 290 mm

Include: taglierina, supporto per bobine e vassoio in plex,
copertura di cotone.

Includes: cutter, reel stand and plex tray, cotton cover.



MART CUTTER

AUTOMATIC RIBBON CUTTER

TAGLIATO PER LA PASTICCERIA CUT OUT FOR PASTRY

Mart Cutter è il taglianastri elettrico ideale per tagliare automaticamente le bobine di acetato della lunghezza desiderata, nella quantità necessaria. Lo strumento consente di ottimizzare e gestire con maggiore semplicità lo stock delle diverse misure, producendo la quantità necessaria di ciascuna lunghezza, evitando errori di taglio e perdite di tempo.

Mart Cutter is the ideal electric ribbon cutter for automatically cutting rolls of acetate to the desired length, in the necessary quantity. The tool makes it easier to optimise and manage the stock of different sizes, producing the necessary quantity of each length, avoiding cutting errors and waste of time.



Selezione manuale o preimpostata di:

Lunghezza di taglio

Numero di pezzi

La macchina si imposta, scegliendo sul display digitale la misura o uno dei programmi preimpostati e la quantità di strisce desiderate.

Manual or preset selection of:

Cutting length

Number of pieces

The machine is set up by choosing on the digital display the size, or one of the programmes that you have preset, and the quantity of strips desired.

Supporto bobine con sedi per accogliere bobine di diverse larghezze mantenendo la centratura di taglio

Roll support with slots to accommodate different heights while maintaining cutting centring



Display digitale a LED per visualizzare le impostazioni scelte e l'avanzamento dello stato del lavoro.

Digital LED display to show selected settings and work status progress.

Vassoio per la raccolta delle strisce tagliate. Dopo l'uso può comodamente essere chiuso per ridurre l'ingombro e proteggere la macchina.

Tray for collecting cut strips. It can be easily folded away after use to reduce clutter and protect the machine.

caratteristiche tecniche/ technical features:

Larghezza bobine Reel width	fino a 60mm Max
Ø Bobine Ø Reel	Ø 210 mm Max
Spessore acetato Acetate thickness	80/150 my
Misure di taglio Length range of cuts	da 5 a 999 mm from 5 to 999 mm

Lunghezze preimpostabili Pre-settable lengths	fino a 6 misure up to 6 sizes
Peso / Weight	2.9 Kg
Potenza / Power	25 W
Tensione elettrica Electric voltage	100V, 120V, 220-240V
Altri cavi alimentazione Other power cable	Su richiesta On request



Scopri di più guardando video di Mart Cutter nel canale YouTube di Martellato
Discover more about Mart Cutter videos on Martellato YouTube channel.

NASTRI - RIBBONS

80my - 305 mt

Extra trasparenti, super resistenti, prodotti con materiale di alta qualità. Facili da usare per rivestire stampi e per realizzare e sformare monoporzioni e mignon. Antiaderenti per uso alimentare. Adatti al raffreddamento in abbattitore, congelatore e frigo, ma non adatti alla cottura.

Extra-clear, super-strong, made of high-quality material. Easy to use for coating moulds and for making and unmoulding monoportions and mignons. Non-stick for food use. Suitable for cooling in blast chillers, freezers and fridges, but not suitable for baking.



Il materiale multistrato con il quale sono realizzati i nostri nastri proviene parzialmente da plastica riciclata. La loro speciale composizione li rendono idonei al contatto alimentare e rispettosi dell'ambiente.

The multi-layer material with which our ribbons are made comes partly from recycled plastic. Their special composition makes them suitable for food contact and environment-friendly.



Tutti i rotoli sono adatti alla taglianastri:

**MART
CUTTER**
AUTOMATIC RIBBON CUTTER



NSA H 25
H 25 mm



NSA H 30
H 30 mm



NSA H 35
H 35 mm



NSA H 40
H 40 mm



NSA H 45
H 45 mm



NSA H 50
H 50 mm



NSA H 55
H 55 mm



NSA H 60
H 60 mm



GUITAR

CUTTER *by* MARTELLATO

Versatile, funzionale e resistente: le caratteristiche della nuova chitarra in alluminio la rendono il tuo partner nella produzione quotidiana. Uno strumento che ti permetterà di lavorare in modo preciso semplificando i passaggi ed **umentando la produttività**. Sarà veloce e facile tagliare cremi, ganache, pasta frolla e sfoglia, tutte le masse morbide, le materie prime ed i prodotti finiti. La struttura è progettata per conferire maggior stabilità e forza nel taglio, ridurre lo sforzo, ottimizzare la produzione, riducendo sprechi, elevando gli standard e l'efficienza.



Versatile, functional and durable: thanks to its features, the new aluminum guitar is your essential partner in daily production.

A tool that will allow you to work precisely, simplifying steps and **increasing productivity**. It will be quick and easy to cut creams, ganaches, shortcrust and puff pastry, all soft masses, raw materials and finished products.

The structure is designed to give greater stability and strength in the cutting process, reducing effort and waste, optimizing production, raising standards and efficiency.



Watch the video in
Martellato's YouTube channel.





- Misura telaio/Frames sizes:
62,2x44,2 cm
- Misura base/Base sizes:
60x40 h 10 cm
- Piano di taglio/Cutting surface:
38x40 cm
- Misura totale/Total sizes:
63,6 x 44,2 h 10,9 cm
- Peso Base/Base weight:
5,5 kg
- Peso Telaio/Frame weight:
5,5 kg

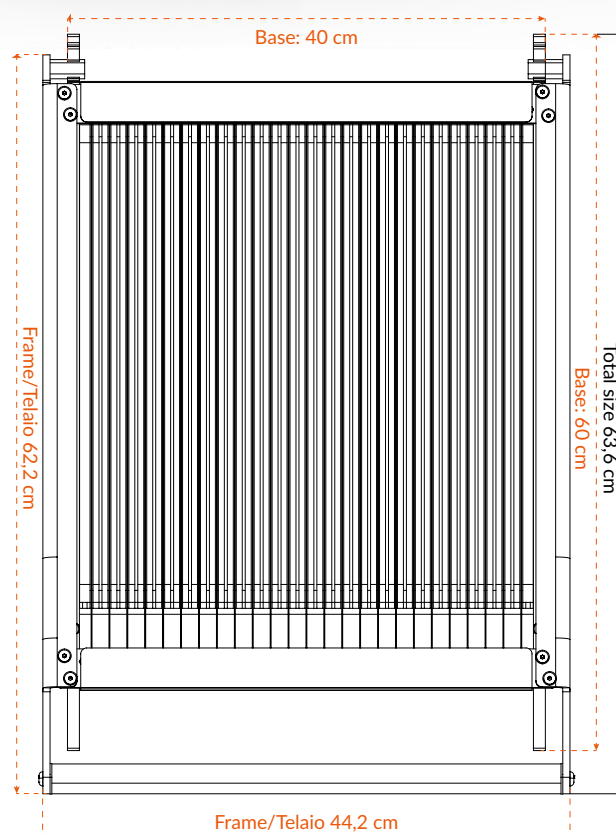

Every Day

with you

BASE

La base, realizzata completamente in alluminio, ha l'**angolo di taglio più ampio per dare maggiore forza meccanica** e ridurre lo sforzo del professionista. E' inoltre più ampia ed allungata per una **maggiore stabilità durante il taglio**. La sua struttura garantisce maggiore maneggevolezza e facilità di pulizia.

The base, made entirely of aluminum, has a **wider cutting angle to give greater mechanical strength** and reduce the professional's effort. It is also wider and longer to give more stability during cutting. Its structure ensures greater handling and ease of cleaning.

FRAME

Telai in acciaio, con manico ergonomico, facilmente intercambiabili grazie a **Easy System**, l'esclusivo sistema di incastro che ne facilita l'inserimento. Sono disponibili in **diverse misure di taglio per consentire varie combinazioni** e creare mignon, monoporzioni, cremini, praline e altro. Sono inclusi vassoio in acciaio e la raplette in plastica per facilitare lo spostamento dei prodotti.

Steel frames, with ergonomic handle, are easily interchangeable thanks to the **Easy System**, the exclusive interlocking system that facilitates insertion. They are available in **different cut sizes to allow various combinations** and create mignons, single portions, cremini, pralines and more. The steel tray and the plastic raplette are included to facilitate the movement of the products.



Full Set



50CS200

- 1 Base 600 x 400 h 100 mm
- 3 telai/frames, misure di taglio/cutting distances:
22,5 - 30 - 45 mm
- 1 Raplette
- 1 Piatto acciaio inox/Stainless steel plate
- 1 Kit assistenza/Service kit
- Misura totale/Total size: 636 x 441 h 109 mm

Base



50CSBA

Piano di taglio/Cutting surface: 380x400 mm
Misura totale/Total size: 600x400 h 100 mm

Frames



50CSTE15 Misura taglio/Cutting size: 15 mm

50CSTE22 Misura taglio/Cutting size: 22,5 mm

50CSTE30 Misura taglio/Cutting size: 30 mm

50CSTE37 Misura taglio/Cutting size: 37,5 mm

50CSTE45 Misura taglio/Cutting size: 45 mm

CHITARRE - GUITARS



Nuova maniglia arrotondata per una comoda impugnatura
New rounded handle for a comfortable grip

Sistema ad incastro
Interlocking system

Elementi in resistente materiale plastico
Resistant plastic elements

Misura di taglio su ogni telaio
Cutting size on each frame

Filo sostituibile singolarmente
Individually replaceable wire

Telai universali in acciaio inox smontabili per agevolare le operazioni di pulizia e manutenzione

Universal stainless steel removable frames to facilitate cleaning and maintenance

La chitarra è lo strumento ideale per tagliare in modo preciso cremini, ganache, gelatine, mignon e masse morbide.

La base di taglio è realizzata in resistente materiale plastico, i telai sono in acciaio inox e i fili intercambiabili singolarmente. La chitarra è composta da una solida base in plastica e da telai di diverse misure, fornibili separatamente in base alle esigenze del singolo operatore, oltre ad essere predisposta per il taglio e il calibro di grandi quantità di prodotti in modo preciso e privo di imperfezioni. Nella confezione delle basi sono presenti: 1 piatto in acciaio inox - 1 racla PST - 3 fili di ricambio - 2 chiavi per il fissaggio fili.

The guitar is the ideal tool for cutting cremini, ganache, jellies, mignons and soft masses precisely.

The cutting base is made of strong plastic material, the frames are made of stainless steel and the wires are individually interchangeable. The guitar consists of a solid plastic base and frames of different sizes, which can be supplied separately according to the needs of the individual operator, as well as being predisposed for cutting and calibrating large quantities of products precisely and without imperfections. In the packaging of the bases there are: 1 stainless steel plate - 1 plastic spatula - 3 spare wires - 2 keys for fixing wires.

DOUBLE

La chitarra doppia permette di tagliare rapidamente il prodotto in un unico passaggio.
Ideale per produrre perfetti quadrati e rettangoli di diverse dimensioni.

The double guitar allows you to quickly cut the product in a single operation.
Ideal for producing perfect squares and rectangles of different sizes.

50-CD100N

BASE CON PIANO DI TAGLIO
BASE WITH CUTTING SURFACE

36X35CM

TELAI NON INCLUSI.
FRAMES NOT INCLUDED.



Telaio base in alluminio
Aluminum base frame

SINGLE

50-CS100

BASE CON PIANO DI TAGLIO
BASE WITH CUTTING SURFACE

36X42CM

TELAI NON INCLUSI.
FRAMES NOT INCLUDED.



Base in polietilene
Polyethylene base

TELAI - FRAMES

Misura-Size: 615x427 mm



TELAIO PER TAGLIO FRONTALE/
FRAME FOR FRONTAL CUTTING

15 mm
50-C015

TELAI PER TAGLIO FRONTALE E LATERALE /
FRAMES FOR FRONTAL AND SIDE CUTTING

22 mm 30 mm 45 mm
50-C022 50-C030 50-C045

Maniglia arrotondata per una comoda impugnatura
Rounded handle for a comfortable grip

Parti ricambio - Spare parts

Piatto Inox
Steel Sheet
CHITRIC 6/D

Spatola Plastica
Plastic spatula
50SPB43
430 h80 mm

Chiavi fissaggio
Special Spanner
CHITRIC 8
2 pcs

Filo Inox
Inox wire
CHITRIC 9
1 pc

Viti e Dadi
Bolts and Nuts
CHITRIC 10
2+2 pcs

CHITARRE MINI GUITARS

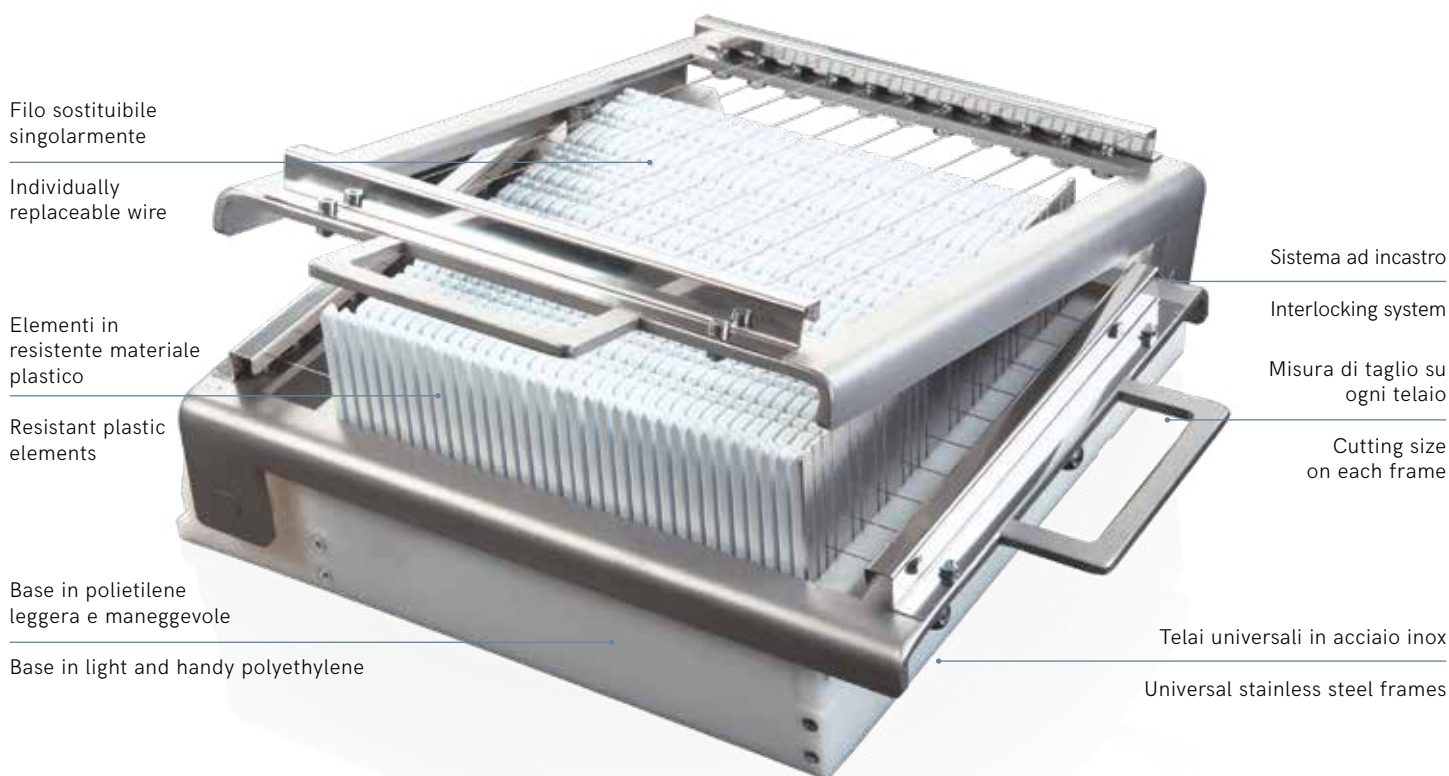

Filo sostituibile singolarmente

Individually replaceable wire

Elementi in resistente materiale plastico

Resistant plastic elements

Base in polietilene leggera e maneggevole

Base in light and handy polyethylene

Sistema ad incastro

Interlocking system

Misura di taglio su ogni telaio

Cutting size on each frame

Telai universali in acciaio inox

Universal stainless steel frames

La MiniChitarra, ideale per ristoranti, gelaterie e cioccolaterie, è adatta a piccole produzioni di prodotti dolciari. Grazie alle dimensioni contenute può essere facilmente riposta anche in piccoli spazi e utilizzata all'occorrenza. Inclusi nella confezione: 1 piatto inox - 1 racla PST - 3 fili di ricambio - 2 chiavi per il fissaggio fili.

The Mini Guitar, ideal for restaurants, ice-cream and chocolate shops, is suitable for small productions of confectionery products. Thanks to its small size it can be easily stored even in small spaces and used when necessary. Included in the package: 1 stainless steel plate - 1 plastic spatula - 3 spare wires - 2 keys for wire fixing.

SINGLE

BASE CONPIANO DI TAGLIO
BASE WITH CUTTING SURFACE

25X28CM

1 TELAIO INCLUSO.
1 FRAME INCLUDED.



COMPLETE CHITMINI15
con 1 telaio 15 mm
with 1 frame 15 mm

COMPLETE CHITMINI
con 1 telai 22 mm
with 1 frame 22 mm

COMPLETE CHITMINI30
con 1 telai 30 mm
with 1 frame 30 mm

BASE SINGLE CHITBA24
Base - senza telai
Base - without frames

DOUBLE

La chitarra doppia permette di tagliare rapidamente il prodotto in un unico passaggio.
Ideale per produrre perfetti quadrati e rettangoli di dimensioni differenti.
Telai smontabili per agevolare le operazioni di pulizia e manutenzione.

The double guitar allows you to quickly cut the product in one step.
Ideal for producing perfect squares and rectangles of different sizes.
Removable frames to facilitate cleaning and maintenance.



BASE CON PIANO DI TAGLIO
BASE WITH CUTTING SURFACE

24X25CM

2 TELAI INCLUSI
2 FRAMES INCLUDED

COMPLETE
CHITMINID22
con 2 telai da 22 mm
with 2 frames 22 mm

COMPLETE
CHITMINID30
con 2 telai da 30 mm
with 2 frames 30 mm



BASE DOUBLE
CHITBAD24
Base - senza telai
Base - without frames

TELAI - FRAMES

Misura-Size: 443x314 mm



TELAIO PER TAGLIO FRONTALE /
FRAME FOR FRONTAL CUTTING

15 mm
CHIT15

TELAIO PER TAGLIO FRONTALE E LATERALE /
FRAME FOR FRONTAL AND SIDE CUTTING

22,5 mm
CHIT22
intercambiabile
interchangeable

30 mm
CHIT30
intercambiabile
interchangeable

Parti ricambio - Spare parts

Piatto Inox
St. steel Sheet
CHITP

Spatola Plastica
Plastic spatula
50SPB30
300 h80 mm

Chiavi Fissaggio
Special Spanner
CHITRIC 8
2 pcs

Filo Inox
Inox wire
CHITRIC 9
1 pc

Viti e Dadi
Bolts and Nuts
CHITRIC 10
2+2 pcs

CHITARRE A SPINTA DRIVING-FORCE GUITARS

Ideale per tagliare cremeni e ganache con frutta secca o prodotti duri e piccola pasticceria anche a bassa temperatura. L'avanzamento del piano di lavoro avviene manualmente, attraverso un volantino azionato dall'operatore, che può controllarne la velocità. Il filo corto garantisce una maggiore resistenza meccanica e consente quindi di tagliare in porzioni precise anche gli impasti più duri o congelati. Facile da pulire, questo strumento non richiede alcuna manutenzione.

Ideal for cutting cremeni and ganache with dried fruit or hard products and small pastries even at low temperature. The advancement of the work table is done manually, through a handwheel operated by the user, who can control its speed. The short wire guarantees greater mechanical resistance and therefore allows even the hardest or frozen dough to be cut into precise portions. Easy to clean, this tool does not require any maintenance.



Manopola di avanzamento grande per permettere un taglio più preciso e delicato

Large hand wheel to allow a more precise and delicate cut

Base di avanzamento asportabile per una migliore pulizia

Removable base for better cleaning

Inserimento dei telai ad incastro

Frame insertion by interlocking

Parti ricambio - Spare parts

Piatto Inox
Steel Sheet

CSM0602

Ideal for:
CSM060 BIG

Spatola
Spatula

CSMSPB60

Ideal for:
CSM060 BIG

Piatto Inox
Steel Sheet

CSM0402

Ideal for:
CSM040 SMALL

Spatola
Spatula

CSMSPB40

Ideal for:
CSM040 SMALL

Chiavi di fissaggio
Spanners

CHITRIC 8

Filo Inox
Inox wire

CHITRIC 9

Inclusi nella confezione delle basi: 1 piatto inox - 1 racla PST - 2 chiavi per il fissaggio fili.
Included in the package: 1 stainless steel plate - 1 plastic spatula - 2 keys for wire fixing.



CSM060

PIANO DI TAGLIO
CUTTING SURFACE

60X60CM

TELAI NON INCLUSI.
FRAMES NOT INCLUDED.

Misura chitarra chiusa
Closed guitar size:
73x103 h30 cm
Misura apertura massima
Maximum open size:
73x167 cm

60X60CM

TELAI - FRAMES

10 MM - CSM06001
15 MM - CSM06002
20 MM - CSM06003
25 MM - CSM06004
30 MM - CSM06005
35 MM - CSM06006
40 MM - CSM06007
50 MM - CSM06008
60 MM - CSM06009

CSM040

PIANO DI TAGLIO
CUTTING SURFACE

40X40CM

TELAI NON INCLUSI.
FRAMES NOT INCLUDED.

Misura chitarra chiusa
Closed guitar size:
53x83 h30 cm
Misura apertura massima
Maximum open size:
53x126 cm

40X40CM

TELAI - FRAMES

10 MM - CSM04001
15 MM - CSM04002
20 MM - CSM04003
25 MM - CSM04004
30 MM - CSM04005
35 MM - CSM04006
40 MM - CSM04007
50 MM - CSM04008
60 MM - CSM04009



PERFECT LAYERS

Stratificazione perfetta! Telai precisi e facili da usare per creare cremini, ganache e gelatine di frutta multi-strato con pesi ed altezze sempre costanti.
Perfect layering! Precise and easy to use frames to create cremini, ganaches and multi-layer fruit jellies with constant weights and heights.

50TLSPECIAL
MISURA INTERNA
INTERNAL SIZE

36X36 CM

2+2 QUADRI INCLUSI.*
2+2 FRAMES INCLUDED.*

* h 3 mm

50TLS03

* h 5 mm

50TLS05

* **Plastic spatula**

50SPB43

430 h80 mm

FOGLI ACETATO

NSA39X39MO

390x390 mm

pack 100 pcs



50TLMINI
MISURA INTERNA
INTERNAL SIZE

24X24 CM

2+2 QUADRI INCLUSI.*
2+2 FRAMES INCLUDED.*

* h 3 mm

50TLM03

* h 5 mm

50TLM05

* **Plastic spatula**

50SPB30

300 h80 mm

FOGLI ACETATO

NSA27X27MO

270x270 mm

pack 100 pcs



SINGLE LAYERS

Telai in acciaio inox per creare precise stratificazioni in cioccolato, biscuit e altri impasti in modo semplice e veloce.
Stainless steels frames to produce perfect layers in chocolate, biscuit and other doughs in easy and fast way.

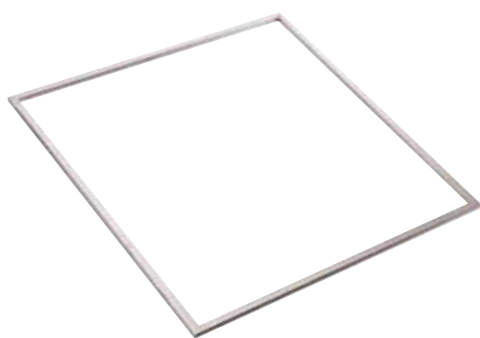

FIXED FRAMES MISURA INTERNA INTERNAL SIZE **36X36CM**

50QG03
h 3 mm

Misura esterna/
External Size: 38x38 cm

50QG10
h 10 mm

Misura esterna/
External Size: 37x37 cm

50QG05
h 5 mm

Misura esterna/
External Size: 38x38 cm

50QG15
h 15 mm

Misura esterna
External Size: 37x37 cm

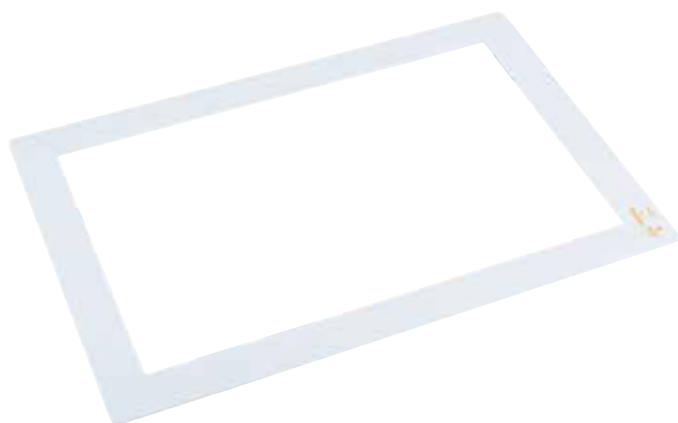

PLASTIC FRAMES MISURA INTERNA INTERNAL SIZE

37X57CM

Misura esterna
External Size: 47x67 cm

TL 03
h 3 mm

TL 04
h 4 mm

TL 05
h 5 mm

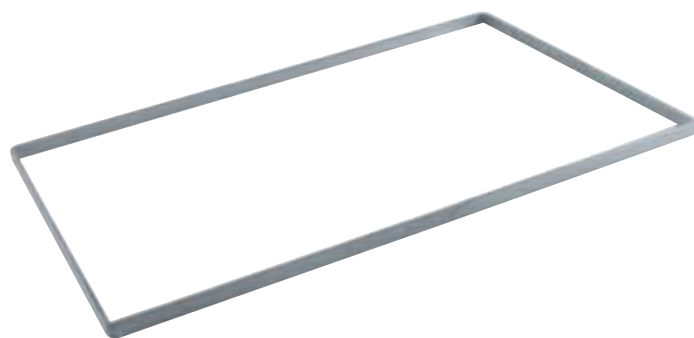

CHARLOTTE FRAME MISURA INTERNA INTERNAL SIZE

38X58CM

Misura esterna
External Size: 39x59 cm

TL 15
h 15 mm

SPINNER

E-Turning Cake

L'indispensabile giratorta elettrico per il tuo laboratorio
Electric Cake Turntable: an essential tool for your laboratory



Composto da un **corpo stabile** con trascinatore circolare sul quale ruota un **piano perfettamente planare** in plexiglass, con **scala graduata** in cm ed inch, consente il corretto e costante posizionamento del prodotto e la misurazione del decoro.

The cake turntable is composed by a **stable base** with circular guide and **planar Plexiglas plate**, with **graduated scale** for the correct and constant positioning of the product and the measurement of the decoration.

Con il regolatore puoi **variare la velocità** e il **senso di rotazione**. I **led direzionali** indicano il senso di rotazione ed in base all'intensità la velocità. Il pratico tappetino in silicone antiscivolo garantirà maggiore stabilità durante la lavorazione.

The regulator allow to **vary speed** and **direction of rotation**. **LEDs indicate direction** and speed of rotation. The practical non-slip silicone mat will ensure greater stability during processing.

Il giratorta elettrico: compatto, pratico e leggero, che semplifica e aiuta il tuo lavoro.

The electric turning cake: compact, practical and light, that simplifies and helps your work.

SPINNER

Misure / Size: 27x26 h 12 cm

Peso / Weight: 1,6 Kg

MADE IN ITALY



Regolatore di velocità

Speed regulator

Anello trascinatore circolare

Roller ring support

Piatto in plexiglass e tappeto in silicone

Plexiglass plate and silicone mat

Piatto con scala graduata da 60 a 220 mm

Graduated plate between 2,36 and 8,66 inch

Luminosità LED proporzionale alla velocità

LED brightness proportional to speed

Rotazione oraria ed antioraria

Clockwise and anti-clockwise rotation



GIRATORTA - CAKE TURNTABLE

Giratorota in alluminio di alta qualità. High quality aluminium alloy cake turntable.

GIRA5

Ø29cm
Giratorota in lega di alluminio, resistente e planare.

Aluminum alloy cake turntable, resistant and flat.



High quality

GIRA6

Ø30cm
Giratorota professionale in lega di alluminio anodizzato, resistente alle abrasioni, agli acidi e facile da pulire.

Professional cake turntable in anodised aluminium alloy, resistant to abrasion, acids and easy to clean.



Giratorota in plastica, semplici e leggeri. Economici, sono strumenti che non possono mancare in pasticceria.

Plastic cake turntable, simple and light. Cost-effective, these tools are a must have in any pastry shop.

Plastica - Plastic

GIRA

Ø32 h10cm



Plastica - Plastic

GIRA7

Ø30,4 h3,2cm



Inclinabile - Tilting

40-W125

Ø23 h14cm
Plastica - Plastic

Giratorota inclinabile, fino a 20°, con tappeto antiscivolo per mantenere stabile e in posizione i dolci.

Tilting cake turner, up to 20°, with non-slip mat to keep cakes stable and in position.



PALA PER DOLCI - CAKE LIFTER

Pala per dolci che rende facile lo spostamento di torte, crostate, pane e articoli da forno. Cake Lifter for easy handling and moving of a whole cakes, tarts, pastry, bread and bakery items.

Acciaio inox - Stainless steel

TS1

Ø28 cm



STENDI PASTA - ROLLING MACHINE

La stendi pasta permette una grande economia di tempo e soprattutto non necessita di personale specializzato per operare. È stata ideata e realizzata per risolvere i problemi di formatura dei dischi per la preparazione di pizze, pane, focacce, tortine, ecc. La macchina lavora a freddo e non altera le caratteristiche della pasta.

La stendi pasta è di semplice utilizzo e offre una qualità costruttiva di altissimo livello.

Selezionare gli spessori per l'impasto finale è un'operazione rapida ed intuitiva.

The rolling machine allows a great economy of time and above all it does not require specialised personnel to operate. It is designed and manufactured to solve the problems of forming discs for the preparation of pizzas, bread, focaccia, cakes, etc.. The machine works cold and does not alter the characteristics of the dough.

The rolling machine is easy to use and offers the highest level of construction quality.

Selecting the thicknesses for the final dough is a quick and intuitive operation.



31 CM

LUNGHEZZA RULLO
ROLLER LENGTH

40-W200

Ingombro totale - Total overall size:
45x35,5 - h37,5cm

50 CM

LUNGHEZZA RULLO
ROLLER LENGTH

40-W20045

Ingombro totale - Total overall size:
65x35,5 - h37,5cm

Scocca di protezione: protezione dei rulli in plexiglass trasparente per la massima sicurezza, senza alterare la visibilità.

Protective Shell: transparent plexiglass roller protection for maximum safety, without altering visibility.

Monorullo in teflon
Teflon single roller

Manopola per la regolazione del spessore
Thickness adjuster knob

1 • 2 • 3 • 4 mm

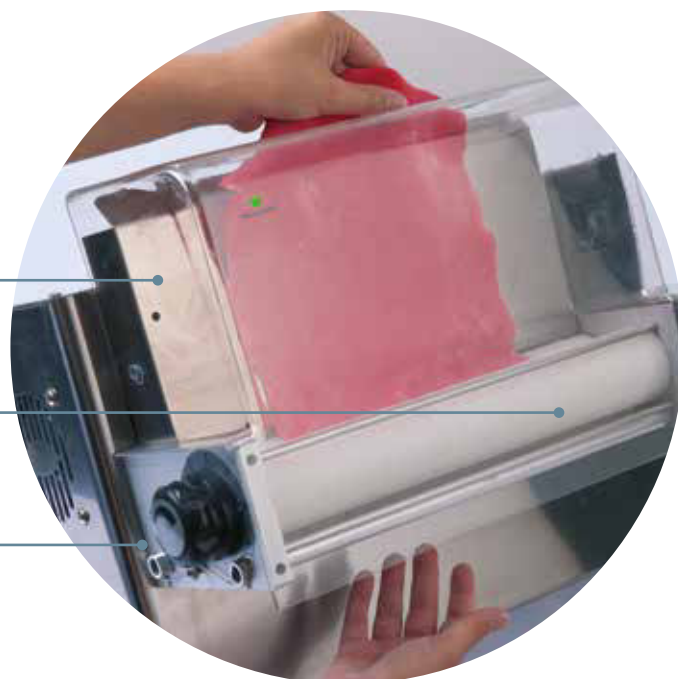

Potenza motore monofase: KW 0,25 - Alimentazione: 230 1ph 50Hz
Single-phase motor power: KW 0,25 - Power supply: 230 1ph 50Hz

EASY COVERS

IL SISTEMA PIÙ COMPLETO PER CONSERVARE I TUOI PRODOTTI
THE MOST COMPLETE SYSTEM TO PROTECT YOUR PRODUCTS

MADE IN ITALY



LEGGEREZZA

Realizzati in materiale plastico di alta qualità, sono ultra leggeri e facili da trasportare

LIGHTNESS

Made of high quality plastic material, they are ultra-light and easy to transport

RESISTENZA

Infrangibili, indeformabili e con elevata elasticità, resistono agli urti anche a bassissime temperature

RESISTANCE

Unbreakable, non-deformable and with high elasticity, they resist to impact even at very low temperatures



PROTEZIONE

La superficie trasparente ed opalescente protegge dalla luce e consente di vedere il prodotto all'interno

PROTECTION

The opalescent and transparent surface protects from light and allows you to see the product inside





COPERCHI E VASSOI IN DIVERSE ALTEZZE E MISURE PER STOCCARE E PROTEGGERE LE VOSTRE CREAZIONI

COVERS AND TRAYS OF DIFFERENT HEIGHTS AND SIZES TO STORE AND PROTECT YOUR CREATIONS

COPERCHI E VASSOI LIDS AND TRAYS

Size cm	Code
59,5x39,5 h 4,2	VC60X404
59,5x39,5 h 6,2	VC60X40
59,5x39,5 h 8,2	VC60X408
30x40 h 6,2	VC30X40

COPERCHI LIDS

Size cm	Code
59x39 h 4	COVER 3H4
59x39 h 4,5	COVER3H45
59x39 h 4,8	COVER3H48
59x39 h 6	COVER 3
59x39 h 8	COVER 8
30x40 h 6	COVER 4



VASSOI TRAYS

Size cm	Code
59,8x39,6 h 2	VASSOIOCMO
39,5x29,8 h 2	VASSOIOBMI

ALTRE MISURE OTHER SIZE

Size cm	Code
59x39,6 h 2,5	VASSOIOCMI
39,5x17,3 h 2	VASSOIOAMO
44x20 h 2	VASSOIOAMI
39,5x25,8 h 2	VASSOIOBMO

CHEF WHIP

Sifone per panna Cream whipper

Lo Chef Whip è adatto per la preparazione veloce di panna montata, spugne mousse, dolci, schiume fredde e salse calde e fredde, oltre ad essere ideale per guarnire cappuccini, caffè, dolci e gelati.

The Chef Whip is suitable for the quick preparation of whipped cream, mousse sponges, sweets, cold foams and hot and cold sauces, as well as being ideal for garnishing cappuccinos, coffee, sweets and ice creams.



Il kit comprende: bottiglia, testata, 3 beccucci e porta capsule in acciaio. Guarnizione di testata in silicone.

The kit includes: bottle, head, 3 spouts and steel capsule holder. Silicone head gasket.

500 ml

50SI01

Sifone per panna
Cream whipper

1000 ml

50SI02

Sifone per panna
Cream whipper



RICARICHE PER SIFONE CREAM CHARGES

50SI01

Cartucce per sifone panna NO2
NO2 cream whipper cartridges
Pack 10 pcs

 Martellato

PISTON FUNNEL

Dosatori professionali in acciaio inox ideale per dosare piccole quantità di prodotto nei bicchierini o negli appositi stampi, in modo **facile e senza sprechi**. Ottimo per salse, gelatine, crème brûlée e marmellate liquide, è fornito di un set di bocchette per una migliore applicazione.

Professional stainless steel funnel ideal for dosing small quantities of product in small cups or in the suitable moulds, in an **easy and waste-free way**. Excellent for sauces, jellies, crème brûlée and liquid jams, it is equipped with a set of nozzles for a better application.



50C001 800 ml

Colino professionale completo: la confezione comprende un piedistallo in metallo e tre bocchette da \varnothing 2 - 4 - 5 mm.
Complete professional funnel: packaging includes a metal support and three nozzles: \varnothing 2 - 4 - 5 mm.



50C002 1900 ml

Colino professionale completo: la confezione comprende un piedistallo in metallo e tre bocchette da \varnothing 4 - 5 - 6 mm.
Complete professional funnel: packaging includes a metal support and three nozzles: \varnothing 4 - 5 - 6 mm.

GRIGNOTTINA - COOKIES MAKER

Strumento per creare velocemente ed in modo preciso "roches", biscotti e altri dolci.
Composto da: 1 telaio in plastica senza fondo - 2 teglie forate (Ø30 - 40 mm) - 1 spatola in plastica

Dosing tool to quickly and precisely create "roches", biscuits and other sweets.
Composed of: 1 plastic saucepan without bottom - 2 perforated trays (Ø30 - 40 mm) - 1 plastic spatula

CIOK 1
60x40 h5 cm



PALLINATORE - BALL MACHINE

Strumento ideale per la produzione di "Baci di Dama", praline e palline di marzapane.
Ideal tool for the production of "Lady's Kisses", pralines and marzipan balls.



Ø 1,6 CM
PALL1

Ø 1,9 CM
PALL2

Ø 2,4 CM
PALL3

BILANCE - SCALES

Precise e facili da usare: pannello touch, funzione tara, indicazione di sovraccarico, indicatore di bassa potenza.
Precise and easy to use: touch panel, tare function, overload indication, low power indicator.



Bilancia piccola - Small scale
50BI01

Superficie in vetro temperato
Tempered glass surface
Div 1g - 0,05oz / 1ml (1/8cup) - max 5 Kg
Batterie incluse - Batteries included
Misura - Size: 22x16 cm



Bilancia grande - Big scale
50BI02

Superficie in acciaio inossidabile
Stainless steel surface
Div 1g - 0,05oz - max 15 Kg
Batterie incluse - Batteries included
Misura - Size: 26x31 cm

RIFRATTOMETRO - REFRACTOMETER

Rifrattometro ottico universale con scala 0-90% Brix, in grado di misurare con precisione, la concentrazione percentuale di sostanze solide, come lo zucchero, in una soluzione fluida.

Universal optical refractometer with 0-90% Brix scale, able to accurately measure the percentage concentration of solid substances, such as sugar, in a fluid solution.



50RI01
Ø3,8 X 14 cm
0-90 % BRIX

TERMOMETRI - THERMOMETERS

Termometri digitali con sonda o ad infrarossi precisi e funzionali.
Precise and functional thermometers with probe or infrared technology.



Termometro elettronico
Electronic thermometer
50T001

Sonda ad immersione
Dipping probe
Celsius -50°C / 300°C
Fahrenheit -58°F / 572°F



Termometro ad infrarossi
Infrared thermometer
50T002

LCD display

Celsius -50°C / 420°C
Fahrenheit -58°F / 788°F



Termometro digitale
Digital thermometer
50T003

Sonda ad immersione - Display e Timer
Dipping probe - Display and Timer

Celsius 0°C / 250°C
Fahrenheit -32°F / 482°F

CONTAINERS

ISOTHERMAL



coperchio incluso
cover included

MAXI 60X40

50CI316040 - Cap. 82,3 Lt
Internal size: 625x425x310 mm
External size: 685X485X370 mm

50CI276040 - Cap. 71,7 Lt
Internal size: 625x425x270 mm
External size: 685X485X330 mm

50CI216040 - Cap. 55,8 Lt
Internal size: 625x425x210 mm
External size: 685X482X270 mm

50CI166040 - 42,5 Lt
Internal size: 625x425x160 mm
External size: 685X485X240 mm



**Piastra eutettica
Eutectic plate**
- 12°C / 0°

50CIA007
Size: 600x400x30 mm
x MAXI

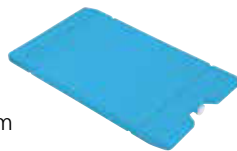

**Piastra eutettica
Eutectic plate**
-6°C / 0°C

50CIA008
Size: 380x215x30 mm
x GASTRONORM
x MAXI



**Carrello plastica
Plastic trolley**

50CIA003
Size: 610x410 mm
x GASTRONORM



GASTRONORM

50CI540GN - Cap. 83 Lt
Internal size: 540x330x480 mm
External size: 650X500X610 mm

MAXI 60X40

50CI6040 - Cap. 128,1 Lt
Internal size: 600x400x500 mm
External size: 720x600x630

ISOTHERMAL RING SYSTEM

50X50



**Terminale
End piece**

50CI5050BC

Internal size: 510x510x63 mm
External size: 570x570x95 mm



**Estensore
Extensor**

50CI5050ES

Internal size: 510x510x95 mm
External size: 570x570x95 mm



PLASTIC BOX

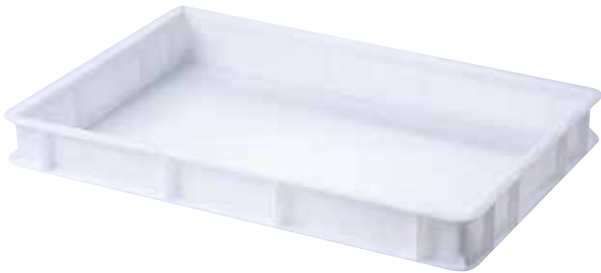

**Cassa fondo chiuso senza maniglie
Closed bottom case without handles**

50CA604007C

50CA604010C

Cap. 12 Lt - 60x40 h 7 Cap. 18 Lt - 60x40 h 10



**Cassa fondo chiuso con maniglie
Closed bottom case with handles**

50CA604013C

Cap. 24 Lt - 60x40 h 13



**Coperchio per casse 60x40
Crate lid 60x40**

50CA6040COP

60x40 cm

MACARON

Espositori in plexiglass per macaron.
Plexiglass displays for macarons.



Gli espositori per macaron possono essere sovrapposti, componendo modelli grandi per aumentarne la capacità.

Macaron displays are stackable, in order to have larger models to increase their capacity.



MACARON 24

80DM01

Ø180x175 mm
cap. 24 pcs
pack 5 displays



MACARON 36

80DM02

Ø245x230 mm
cap. 36 pcs

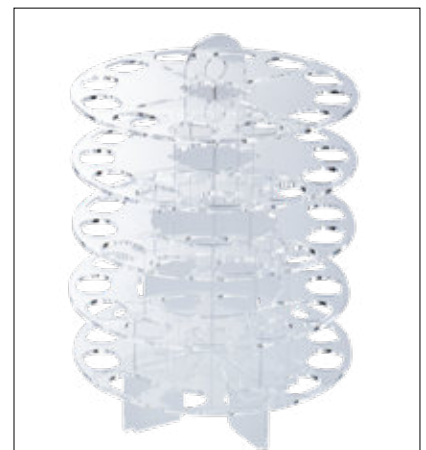

MACARON 60

80DM03

Ø245x355 mm
cap. 60pcs

MACARON

Espositori in plexiglass per macaron.
Plexiglass displays for macarons.



AG05701

460x330 h145 mm
7 file / rows
cap. 70 pcs approx



AG05601

270x330 h145 mm
4 file / rows
cap. 70 pcs approx

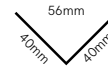

AG05801

315x325 h65 mm
5 file / rows
cap. 50 pcs approx



AG07901

350x350 h450 mm
cap. 60 pcs



AG07701P
Ø240 h 280 mm
cap. 30 pcs



AG07701
Ø280 h430 mm
cap. 62 pcs

PLEXIGLASS DISPLAY CASES





Vetrina con porta - Display with door

VB00900

bianco - white

49,5x37,5 h52 cm - 2 piani - shelves



Vetrina con porta - Display with door

VB00904

rosso - red

49,5x37,5 h52 cm - 2 piani - shelves



Vetrina con porta - Display with door

VB00908

nero - black

49,5x37,5 h52 cm - 2 piani - shelves

VETRINE - DISPLAY CASES



Vetrina con 2 ripiani e porta
Display with 2 shelves and door

VB00802

31,5x30,5 h.30,5 cm - 2 ripiani/shelves
distanza fra i piani/shelves distance h.16 cm



Vetrina con 3 ripiani e porta
Display with 3 shelves and door

VB00804

31,5x30,5 h.45 cm - 3 ripiani/shelves
distanza fra i piani/shelves distance h.16 cm



Vetrinetta multiuso
Multi-function display

VB00803

37x31 h.32,5 cm - 2 ripiani/shelves
distanza fra i piani/shelves distance h.15 cm

Ideale per esporre coni e brioches
Ideal to display cones and brioches



Vetrina 1 porta
Display with 1 door

VB00306 - 41x36,5 - h44 cm

3 piani inclinati - inclined shelves 11cm



Vetrina con 1 porta
Display with 1 door

VB00408 - 37x31 - h31 cm
3 piani/shelves 10cm



Vetrina a LED - 3 piani inclinati e porta
LED display - 3 inclined shelves & door

VB00308 - 39,5x32,5 - h50,5



Vetrina con 3 piani inclinati e porta
Display with 3 inclined shelves and door
 42x31 h 42,5 - 27,5x39,5cm

VB00200 Bianco - White

VB00201 Trasp. - Trans.

VB00208 Nero - Black



Vetrina con 2 ripiani e 4 porte
Display with 2 shelves and 4 doors

VB00102 - 60x37 h 40cm

4 porte su due lati - 4 doors on two sides



Vetrina con 2 ripiani e 2 porte
Display with 2 shelves and 2 doors

VB00501 - 2 piani/shelves
 50x38 h45,5 cm



Vetrina con 2 vassoi e porta
Display with 2 trays and door

AR02801 - 49,5x31 - h27 cm

1 lato aperto - 2 cassetti

1 open side - 2 drawers

Misure personalizzabili su richiesta
 Measures can be changed on request

Proteggi brioches
Plexiglass food shields

Misure personalizzabili su richiesta
 Measures can be changed on request



AR0001 - 49,5x30 - h27 cm

AR00011 - 99,5x30 - h27 cm



Con battuta 4 cm - With 4cm batting

AR0001B - 49,5x30 - h27 cm

AR00011B - 99,5x30 - h27 cm

PLEXIGLASS DISPLAYS



Vetrina - Display

VP00101

60x36cm - h16cm

Accessori interni non inclusi
Internal accessories not included



Vassoio - Tray

VP00401

34X11cm - h2cm



Piatto - Plate

VP00501

32X9cm - h0,2cm

Vassoio - Tray

VP00700

18X29cm - h2,5cm



Piatto - Plate

VP00801

13X24cm - h0,2cm

Vassoio - Tray

50VP00402

14x40 h.2 cm

Praline mini display

COD. 604

22x27 h30 cm



Alzata 5 piani - 5 plates display

COD. 605

piani/plates: ø 36, 28, 20, 12, 5 - h27cm

altezza tra i piani 5 cm

height between plates 5 cm



PLEXIGLASS PLATES



Su richiesta ampia gamma di colori e misure realizzabili
On request different colors and sizes



145 x 400 h 20 mm

Colore - Color	Code
Bianco - White	50VP0500
Nero - Black	50VP0508

145 x 289 h 20 mm

Colore - Color	Code
Bianco - White	50VP0600
Nero - Black	50VP0608

204 x 258 h 20 mm

Colore - Color	Code
Bianco - White	50VP0700
Nero - Black	50VP0708

294 x 394 h 20 mm

Colore - Color	Code
Bianco - White	50VP0800
Nero - Black	50VP0808

plexiglass nero - black plexiglass

Size mm	thickness	Code
200x100	5	50VP201008
200x200	5	50VP202008
250x120	5	50VP251208
250x250	5	50VP252508
600x100	5	50VP601008
600x250	5	50VP602508



Vassoio - Tray
VP00500
32x20cm - h2,5cm



Piatto - Plate
VP00601
26x15cm - h0,2cm



Vassoio - Tray
VP00206
17x17cm - h2cm

Piatto - Plate
VP00301
16,5x16,5cm - h0,2cm

Vassoio - Tray
VP01106
17x23cm - h2cm

Piatto - Plate
VP01201
16,5x22,5cm - h0,2cm

Vassoio - Tray
VP00906
10x50cm - h2cm

Piatto - Plate
VP01001
9,5x49,5cm - h0,2cm



PROFESSIONAL TOOLS

Mart Poche



UNA LINEA COMPLETA DI SAC À POCHE MONOUSO
A COMPLETE LINE OF DISPOSABLE PASTRY BAGS

MADE IN ITALY by MARTELLATO



RESISTENTI, ANTISCIVOLO, IGIENICHE, FACILI
DA UTILIZZARE, CON SALDATURA SOTTILE
RESISTANT, NON-SLIP, HYGIENIC, EASY TO USE,
WITH THIN SEAL

ALTA QUALITÀ MADE IN ITALY

Pensate per facilitare il lavoro quotidiano dei professionisti grazie alle caratteristiche dei diversi modelli, le sac à poche monouso Martellato sono conosciute ed apprezzate in tutto il mondo.

La produzione è interamente italiana, dalla materia prima accuratamente selezionata alla lavorazione, sotto l'attento controllo di Martellato che, grazie all'impiego delle più **moderne tecnologie** e nel rispetto delle direttive internazionali, è in grado di offrire **sacchetti di alta qualità**.

I NOSTRI PLUS

Velocità e precisione, **presa sicura antiscivolo** e **alta resistenza**, fanno delle sac à poche prodotte da Martellato un prezioso alleato di pasticceri e chef. Un'**unica saldatura, più sottile** per consentire maggiore praticità e **più resistente** per evitarne la rottura durante l'uso, insieme al **materiale multistrato di alta qualità**, garantiscono la durata delle sac à poche per molto tempo, consentendo di riempirle **più volte durante l'utilizzo**. Possono essere utilizzate con composti caldi e freddi, duri o morbidi e sono adatte per l'utilizzo sia in abbattitore che in microonde.

HIGH QUALITY MADE IN ITALY

Designed to facilitate the daily work of professionals thanks to the characteristics of the different models, the Martellato disposable pastry bags are known and appreciated all over the world.

The production of the pastry bags is entirely Italian, from the raw material to processing, under the careful control of Martellato that, thanks to the use of the most **modern technologies** and in compliance with international directives, can offer **high quality bags**.

OUR PLUS

Speed and precision, non-slip **secure grip** and **high resistance**, make the pastry bags produced by Martellato a precious ally of both confectioners and chefs. **A single seall, thinner** for improved practicality and more resistant to prevent any breakage during use, together with the high quality **multi-layered material**, guarantee these pastry bags last over time, allowing to fill them over and over again during the use. They can be used with hot or cold, hard or soft preparations and are suitable for refrigerators and microwave ovens.

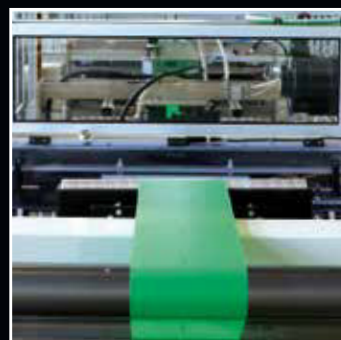

Soft touch: funzionalità e comfort
Soft touch: functionality and comfort

Blue Poche

EXTRA
COMFORT



Sacchetti monouso in polietilene multistrato con **esclusivo trattamento antiscivolo** all'esterno che conferisce una **piacevole sensazione al tatto** e **maggiore flessibilità**. L'interno liscio facilita la fuoriuscita dei composti, dei composti caldi, freddi, duri o morbidi.

Disposable pastry bags in multi-layered polyethylene, with **exclusive anti-slip treatment** on the outside them gives it a **pleasant sensation at the touch** and **greater flexibility**. The slick interior facilitates the release of doughs, whether hot, cold, hard or soft.

MYCRON
80
MY



H 30 CM
50-2030
Dispenser box
100 pcs

H 40 CM
50-2040
Dispenser box
100 pcs

H 55 CM
50-2055
Dispenser box
100 pcs

H 65 CM
50-2065
Dispenser box
100 pcs

GRIP EFFECT

MYCRON
80
MY



Antiscivolo, resistente e sicuro:
massima qualità made in Italy
Resistant, non-slip and safe:
top quality made in Italy

Green Poche

Sacchetti monouso in polietilene **multistrato** verde con rivestimento **antiscivolo all'esterno** pensato per assicurare, anche con mani umide, una presa sicura. All'interno, invece, la superficie è liscia per consentire al prodotto di uscire facilmente.

Disposable pastry bags in green multilayer polyethylene with non-slip coating on the outside designed to ensure a secure grip, even with wet hands. Inside, however, the surface is smooth to allow the product to come out easily.



H 30 CM
50-1030
Dispenser box
100 pcs

H 40 CM
50-1040
Dispenser box
100 pcs

H 55 CM
50-1055
Dispenser box
100 pcs

H 65 CM
50-1065
Dispenser box
100 pcs

H 30 CM
50103020STD
Roll 20 pcs

H 40 CM
50104020STD
Roll 20 pcs

H 55 CM
50105520STD
Roll 20 pcs



SUPER RESISTANT

MYCRON
80
MY



Trasparente, super resistente:
un alleato indispensabile nel tuo laboratorio
Transparent, super-resistant:
an indispensable help in your laboratory

Crystal Poche

Sacchetti monouso in polietilene **trasparente extra forte**, adatti anche per gli impasti più duri e **riempibili numerose volte**.

Extra-strong, transparent polyethylene disposable pastry bags, suitable for even the toughest mixes and can be filled many times over.



H 30 CM
ROLL H 30
Dispenser box
100 pcs

H 40 CM
ROLL H 40
Dispenser box
100 pcs

H 55 CM
ROLL H 55
Dispenser box
100 pcs

H 65 CM
ROLL H 65
Dispenser box
100 pcs

H 30 CM
ROLLH3020STD
Roll 20 pcs

H 40 CM
ROLLH4020STD
Roll 20 pcs

H 55 CM
ROLLH5520STD
Roll 20 pcs



COTTON

Sacchetti per pasticceria riutilizzabili, prodotti con fibre naturali di **cotone** rivestito di poliuretano per dare maggiore resistenza alla pressione, con asola e **punta rinforzata**.
Ideali per impasti più duri.

Pastry bags made of **natural cotton** fibers coated with polyurethane to give greater resistance to pressure. Turned and sewed rimes, **reinforced tip**.
Ideal for harder doughs.



Size cm	Code
25	STD 025 CM
28	STD 028 CM
34	STD 034 CM
40	STD 040 CM
46	STD 046 CM
50	STD 050 CM
55	STD 055 CM
60	STD 060 CM
65	STD 065 CM
70	STD 070 CM
75	STD 075 CM

FLEX

Sacchetti per pasticceria riutilizzabili, prodotti con fibre di **poliestere** rivestite di poliuretano, con asola.

Pastry bags made of polyurethane coated **polyester** fibers, with welded seam.



Size cm	Code
25	FLEX 025 CM
28	FLEX 028 CM
34	FLEX 034 CM
40	FLEX 040 CM
46	FLEX 046 CM
50	FLEX 050 CM
55	FLEX 055 CM
60	FLEX 060 CM
65	FLEX 065 CM
70	FLEX 070 CM

SuperFlex

Simply **unbreakable!**

Il nuovo sacchetto è realizzato in materiale innovativo, idoneo al contatto alimentare, che conferisce al prodotto un'elevata resistenza, flessibilità e morbidezza.

Superflex presenta una superficie liscia all'interno, che facilita la fuoriuscita del prodotto, e ruvida all'esterno, per garantire un'impugnatura più sicura.

Elevatissima resistenza alla trazione e facilità di lavaggio e pulizia, conferiscono una durata di molto superiore a quella degli altri sacchetti in commercio, che utilizzano materiali diversi.

Grazie allo speciale sistema di saldatura del sacchetto, l'igiene è maggiormente garantita. Non trattiene né assorbe lo sporco e l'impermeabilizzazione è resistente nel tempo, non essendo soggetta ad usura

Resiste fino a 100°C ed è adatto al microonde.

The new pastry bag is made of an innovative material that is suitable for food contact and gives the product high resistance, flexibility and softness.

Superflex has a inner smooth surface which facilitates the release of the cream, and a rough one on the outside in order to ensure a safer handle.

Very tensile strong and easy to wash and clean, they give a much longer durability than other bags on the market, made of different materials.

Thanks to the special sealing system of the bag, hygiene is highly guaranteed.

As not subject to wear, the pastry bag neither retain nor absorb dirt and the waterproofing will be resistant over time.

It resists up to 100°C and is suitable for microwave use.



Senza Imballo - Unpacked

34 CM
SPR034

45 CM
SPR045

50 CM
SPR050



Con Imballo - With package

34 CM
SPR034/C

45 CM
SPR045/C

50 CM
SPR050/C

PRECUT

Sac à poche monouso pretagliati per alimenti in polietilene trasparente, **spessore 80 micron**.
Disposable precut pastry bags for food made of transparent polyethylene, **80 microns thick**.

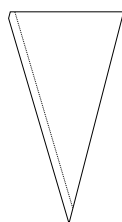

Confezionati in cartone con euroforo.
Packed in cardboard boxes with euro-perforation.

Size cm	pcs box	Code	Size cm	pcs box	Code
23x45	100	SAC45X100	30x55	100	SAC58X100

Vaso porta sac à poche Pastry bag holder

Accessorio ideale per riporre la sac à poche in uso.

Ideal accessory for storing the pastry bag in use.



50VA001A
Ø200 - h240 mm
Arancione - Orange



50VA001V
Ø200 - h240 mm
Verde - Green

Piping tips

Ampia gamma di bocchette in acciaio inox prodotte senza saldature per garantire la massima resistenza
Wide range of stainless steel nozzles produced without welding to guarantee maximum resistance

pack 5 pezzi - pieces

Dove non espressamente indicato le confezioni si intendono da **5 pezzi** - le misure sono in millimetri
If not indicated, the package contains **5 pieces** - the measurements are in millimeters

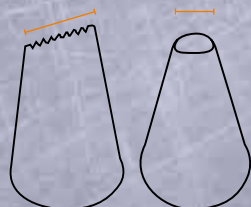

TIP

misura foro di uscita
spout hole size

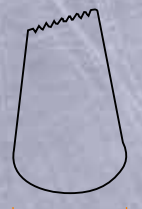

misure esterne
external size

TONDA - ROUND



KIT 10 pcs Mix - Ø 4 - 5 - 6 - 7 - 8 - 9 - 10 - 12 - 13 - 15 mm
BS 10 T

TIP Ø2 BT 202 Ø25 h 50	TIP Ø3 BT 203 Ø25 h 50	TIP Ø4 BT 204 Ø25 h 45	TIP Ø5 BT 205 Ø25 h 45	TIP Ø6 BT 206 Ø25 h 45
TIP Ø7 BT 207 Ø25 h 45	TIP Ø8 BT 208 Ø25 h 45	TIP Ø9 BT 209 Ø25 h 45	TIP Ø10 BT 210 Ø30 h 50	TIP Ø11 BT 211 Ø30 h 50
TIP Ø12 BT 212 Ø30 h 47	TIP Ø13 BT 213 Ø30 h 47	TIP Ø14 BT 214 Ø30 h 47	TIP Ø15 BT 215 Ø35 h 50	TIP Ø16 BT 216 Ø35 h 50
TIP Ø17 BT 217 Ø35 h 50	TIP Ø18 BT 218 Ø35 h 50	TIP Ø20 BT 220 Ø35 h 47	TIP Ø22 BT 222 Ø35 h 47	TIP Ø24 BT 224 Ø35 h 43

STELLA APERTA - OPEN STAR



KIT 10 pcs Mix - Ø 4 - 5 - 6 - 7 - 8 - 9 - 10 - 12 - 13 - 15 mm
BS 10 S

TIP Ø2 BS 102 Ø25 h 50	TIP Ø3 BS 103 Ø25 h 50	TIP Ø4 BS 104 Ø25 h 50	TIP Ø5 BS 105 Ø25 h 50	TIP Ø6 BS 106 Ø25 h 45
TIP Ø7 BS 107 Ø25 h 50	TIP Ø8 BS 108 Ø25 h 45	TIP Ø9 BS 109 Ø25 h 40	TIP Ø10 BS 110 Ø30 h 50	TIP Ø11 BS 111 Ø30 h 50
TIP Ø12 BS 112 Ø30 h 50	TIP Ø13 BS 113 Ø30 h 50	TIP Ø14 BS 114 Ø35 h 55	TIP Ø15 BS 115 Ø35 h 50	TIP Ø16 BS 116 Ø35 h 50
TIP Ø17 BS 117 Ø35 h 50	TIP Ø18 BS 118 Ø35 h 50			

STELLA FRANCESE - FRENCH STAR



TIP Ø4 BF 310 Ø25 h 45	TIP Ø6 BF 311 Ø25 h 45	TIP Ø7 BF 312 Ø25 h 45	TIP Ø9 BF 313 Ø25 h 45	TIP Ø10 BF 314 Ø30 h 50
TIP Ø11 BF 314/11 Ø30 h 50	TIP Ø12 BF 315 Ø30 h 45	TIP Ø13 BF 316 Ø30 h 50	TIP Ø15 BF 317 Ø35 h 50	TIP Ø16 BF 318 Ø35 h 50
TIP Ø18 BF 319 Ø35 h 50	TIP Ø16 BF 0867 Ø35 h 50	TIP Ø20 BF 0869 Ø35 h 48		

STELLA CHIUSA - CLOSED STAR



TIP Ø2 BC 320 Ø25 h 47	TIP Ø3 BC 321 Ø25 h 47	TIP Ø4 BC 322 Ø25 h 47	TIP Ø5 BC 323 Ø25 h 47	TIP Ø6 BC 324 Ø25 h 43
TIP Ø7 BC 325 Ø35 h 50	TIP Ø8 BC 326 Ø30 h 50	TIP Ø9 BC 327 Ø30 h 50	TIP Ø10 BC 328 Ø35 h 53	TIP Ø11 BC 329 Ø35 h 50
TIP Ø12 BC 330 Ø35 h 50				

FANCY PIPING NOZZLES



TIP Ø5
BX 1820 - Ø30 H 42



TIP Ø23
BX0001 - Ø37 H 42



TIP Ø23
BX0009 - Ø37 H 42



TIP Ø20
BX 0252 - Ø30 H 40



TIP Ø20
BX 0250 - Ø30 H 40



TIP Ø 0,4
BX0028 - Ø18 H 37



TIP Ø 0,6
BX0029 - Ø18 H 35



TIP Ø 0,9
BX0030 - Ø18 H 36



TIP Ø4
BX0031 - Ø18 H 34



TIP 4x4
BX0032 - Ø18 H 34



TIP 3x3
BX0033 - Ø18 H 33



TIP 5x5
BX0034 - Ø18 H 33



TIP Ø8
BX0038 - Ø18 H 28



TIP Ø9
BX0047 - Ø18 H 26



TIP Ø5
BX0042 - Ø18 H 30



TIP Ø7
BX0045 - Ø18 H 31



TIP Ø10
BX0046 - Ø18 H 30



TIP Ø2
BX0048 - Ø18 H 30

BASKET PIPING NOZZLES



TIP 17
BX 9017
Ø30 h 50



TIP 20
BX 9022
Ø30 h 45



TIP 16x2
BD 300
Ø25 h 40



TIP 20x3
BD 301
Ø30 h 43



TIP 27
BD 302
Ø35 h 45

STRIPES & BORDER



TIP Ø10
BX9990 - Ø30 H 50



TIP Ø12
BX9991 - Ø30 H 50



TIP Ø14
BX9992 - Ø30 H 50



TIP Ø13 L20
BX 2312 - Ø25 H 40



TIP Ø12 L16
BX 2314 - Ø25 H 40



TIP Ø14 L20
BX 2315 - Ø30 H 45



TIP Ø13 L25
BX 1510 - Ø30 H 45



TIP 16
BX 1303 - Ø25 H 40



TIP 18x4
BX 1217 - Ø25 H 37



TIP 20x7
BX 1405 - Ø25 H 40



TIP 16x2
BX 0116 - Ø25 H 40



TIP 19x2
BX 0119 - Ø25 H 40



TIP 12x3
BX 1906 - Ø35 H 45



TIP 15x2
BX 0134 - Ø25 H 42



TIP Ø5
BX 3005 - Ø35 H 50



TIP 15x5
BX 0158 - Ø25 H 45



TIP 25
BX0026
Ø18 h 36



TIP 25
BX0027
Ø18 h 36



TIP Ø5
BX0039
Ø18 h 32



TIP 10
BX0043
Ø18 h 28



TIP Ø6
BX0040
Ø18 h 30



TIP Ø8
BX0044
Ø18 h 28



TIP Ø7
BX0049
Ø18 h 30



TIP 9
BX 8019
Ø17 h 28

pack 5 pezzi - pieces

FLOWER & PETALS NOZZLES



TIP Ø3 - BX 0190
Ø25 h 43



TIP Ø5 - BX 4014
Ø25 h 45



TIP 13 - BX 1013
Ø25 h 43



TIP 13 - BX 0108
Ø25 h 40



TIP Ø15 - BX 5017
Ø30 h 43



TIP Ø6 - BX 6018
Ø30 h 45



TIP 18 - BS 0F6K
Ø30 h 45



TIP 6 - BS 0D6K
Ø25 h 42



TIP Ø13 - BA 413
Ø30 h 47



TIP Ø15 - BA 415
Ø35 h 53



TIP Ø5 - BX 0510
Ø25 h 42



TIP Ø10 - BX 7020
Ø30 h 45



TIP Ø6 - BS 0195
Ø25 h 42



TIP Ø10 - BS 0195K
Ø25 h 40



TIP Ø8 - BC 0855
Ø30 h 45



TIP Ø15 - BR 330
Ø30 h 50



TIP Ø8 - BX 2013
Ø25 h 40



TIP Ø20 - BR 331
Ø30 h 45



TIP Ø8 - BR 332
Ø35 h 50



TIP Ø11 - BA 411
Ø30 h 50



TIP 17 - BX 0123
Ø24 h 40



TIP 13x2 - BX 0120
Ø24 h 43



TIP 17x2
BX 1105
Ø25 h 40



TIP 18
BX 1115
Ø25 h 50



TIP 16
BX 1123
Ø25 h 40



TIP 14
BX 1132
Ø25 h 40



TIP 8
BX 1605
Ø25 h 45



TIP 10
BX0041
Ø18 h 34



TIP 5x1
BX0035
Ø18 h 35



TIP 7x1,5
BX0036
Ø18 h 35



TIP 10x3
BX0037
Ø18 h 33

Floral piping tips



BX 2117
Ø25 h 40 TIP Ø1



BX 1713
Ø25 h 40 TIP Ø2



BX 0012
Ø37 h 42 TIP Ø23



BX 2219
Ø30 h 40 TIP Ø2



BX 0002
Ø37 h 42



BX 0004
Ø37 h 42



BX 0006
Ø37 h 42



BX 0008
Ø37 h 42



BX 0011
Ø37 h 42



BX 0014
Ø37 h 42



BX 0016
Ø37 h 42



BX 0017
Ø37 h 42



BX 0023
Ø37 h 42



BX 0051
Ø35 h 38



BX 0052
Ø35 h 38



BX 0053
Ø35 h 38



BX 0054
Ø37 h 42



BX 0055
Ø37 h 42



BX 0056
Ø37 h 42



BX 0057
Ø37 h 42



BX 0058
Ø37 h 42



BX 0059
Ø37 h 42



BX 0060
Ø37 h 42



BX 0061
Ø37 h 42



BX 0062
Ø37 h 42



BOS12FLO
Box 12 pcs

Sphere piping tips ball



TIP Ø22
BX0100
Ø32 h 60 TIP Ø22
Pack 1 pc



TIP Ø22
BX0101
Ø32 h 57
Pack 1 pc



TIP Ø22
BX0102
Ø32 h 57 TIP Ø22
Pack 1 pc



TIP Ø22
BX0103
Ø32 h 57 TIP Ø22
Pack 1 pc



TIP Ø22
BX0104
Ø32 h 57 TIP Ø22
Pack 1 pc

FILLING NOZZLES

TIP Ø4
BIM 340
Ø25 h 90
Pack 5 pcs



TIP Ø8
BIM 232
Ø25 h 95
Pack 5 pcs



TIP Ø6
BIM 230
Ø5 h 75
Pack 5 pcs



TIP 31
BXB01
Ø55 h 60 TIP Ø31
pack 1 pc



TIP 31
BXB02
Ø55 h 56 TIP Ø31
pack 1 pc



ADAPTERS



Piccolo - Small
50AD001
pack 1 pc
base Ø18 mm



Medi - Medium
50AD002
kit 2 pcs
base Ø25 - Ø31 mm



Grande - Large
50AD003
pack 1 pc
base Ø36mm



Floreal
piping tips



Sphere ball
piping tips

Floreal & Sphere Ball
50AD004
pack 2 pcs
Per bocchette a sfera e floreali
For sphere ball and floreal tips

Bi & Tri COLOR



Kit di adattatori, per realizzare decorazioni a due o tre colori.
Adapter kit suitable to prepare decorations with two or three colours.



BI & TRI COLOR
40-WA010
pack 2 pcs
Adatto a bocchette Ø30 h 50
Suitable for piping tips Ø30 h 50



Big Size
BOSPL1
Box 12 pcs
Plastica - Plastic



Scatola - Box
BOSPL3
Box 20 pcs
Bocchette in plastica - con adattatore
Plastic piping tips - with adapter



Kit 6 Pezzi
BPL6
6 pcs
Plastica - Plastic

Bruschino - Brush

BRU

Setole in nylon ed impugnatura in plastica.
Forma conica ideale per la pulizia di tutti i modelli di bocchetta.



Nylon bristles and plastic handle.
Conical shape ideal for cleaning all the nozzle models.



**Bocchette miste
Mixed piping tips**

BOS 36 BIG

h 50 mm

il kit include:

36 bocchette miste

3 adattatori

pratica scatola in plastica

the kit includes:

36 mixed piping tips

3 adapters

practical plastic box

**Bocchette da decorazione
Decorative piping tips**

BOS 52

h 33 mm

il kit include: 52 bocchette miste - 1 adattatore

2 chiodi per fiori - pratica scatola in plastica

the kit includes: 52 mixed piping tips - 1 adapter

2 nails for flowers - practical plastic box



Bocchette da decorazione- Decorative piping tips

BOS 26

h 33 mm

il kit include: 26 bocchette miste - 1 adattatore

2 chiodi per fiori - pratica scatola in plastica

the kit includes: 26 mixed piping tips - 1 adapter

2 nails for flowers - practical plastic box





Espositore in plexiglass
Plexiglass display

ESPOB60

Size: 515x315 h210mm
for 60 piping tips - with crowner



Portabocchette in plexiglass
Plexiglass piping tips holder

ESPOBO32

Size: 310x100 h390mm
con anta protettiva
with protective door

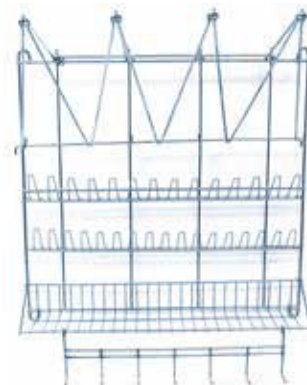

Espositore per bocchette e sacchetti
Wall rack for piping tips & pastry bags

Size: 510x350 h490mm

ESPO ST

Inox - Stainless steel



Le più iconiche tra le sac à poche prodotte da Martellato sono proposte in una inedita confezione da 20 pezzi, per rispondere alle diverse richieste dei professionisti.

Gli esclusivi box in plexiglass ne consentiranno l'esposizione nei punti vendita o lo stoccaggio organizzato in laboratorio.

The most iconic among the Martellato's sac a poche are now available in a brand new 20-piece package, to meet the different needs of professionals.

The exclusive plexiglass boxes will allow them to be displayed at points of sale or stored in the laboratory.

for ROLL H 30 CM

ESPOP30

190x250 h 210 mm
cap. 18 pcs

for ROLL H 40 CM

ESPOP40

250x250 h 230 mm
cap. 18 pcs

for ROLL H 55 CM

ESPOP55

310x250 h 260 mm
cap. 18 pcs

TOP

Spatula Pro

HIGH TEMPERATURE SPATULA



50SC350

Total 350x65 mm
Manico/Handle 235 mm

50SC400

Total 400x65 mm
Manico/Handle 285 mm



Spatole professionali per alte temperature multiuso di alta qualità con cucchiaino in silicone ed impugnatura ergonomica in plastica. Progettate per resistere alle alte temperature **fino a 230°C (446°F)**, la loro speciale impugnatura in fibra di vetro e nylon garantisce il comfort di una presa sicura durante l'uso.

High temperatures Spatulas, high quality, professional and multi-purpose with silicone blade and ergonomic nylon handle. That spatulas are designed to resist heat **up to 230°C (446°F)**. The sure-grip handle ensures a solid grip during use, increasing safety while maintaining comfort.

SPATOLE MORBIDE IN PLASTICA

SOFT PLASTIC SPATULAS

Spatola professionale bicomponente con cucchiaino in gomma e manico in plastica resistente rigida.
Resistente a temperature fino a 100°C
Professional two-component spatula with rubber spoon and resistant rigid plastic handle.
Temperature resistant up to 100°C



50GO300

Manico - Handle 195 mm
Total size 310x70 mm

50GO350

Manico - Handle 235 mm
Total size 350x70 mm

50GO400

Manico - Handle 285 mm
Total size 400x70 mm

50GO275

Manico - Handle 187 mm
Total size 275x49 mm
extra soft



Spatola professionale con anima interna rivestita in materiale termoplastico bianco morbido.
Resistente a temperature fino a 100°C
Professional spatula with internal core covered in soft white thermoplastic material.
Resistant to temperatures up to 100°C



50SG250B

Manico - Handle 170 mm
Total size 254x42 mm

50SG300B

Manico - Handle 198 mm
Total size 305x51 mm

50SG350B

Manico - Handle 237 mm
Total size 355x59 mm

Spatola professionale bicomponente con cucchiaino in gomma e manico in plastica resistente rigida.
Resistente a temperature fino a 70°C.
Professional two-component spatula with rubber spoon and rigid resistant plastic handle.
Resistant to temperatures up to 70°C.



MEL 250

Manico - Handle 165 mm
Total size 250 mm

MEL 350

Manico - Handle 235 mm
Total size 350 mm

MEL 450

Manico - Handle 335 mm
Total size 450 mm

SPATOLE RIGIDE IN PLASTICA

HARD PLASTIC SPATULAS

Spatola rigida monopezzo, materiale ABS bianco resistente a temperature fino a 100°C
Cucchiaino rettangolare sottile, manico ergonomico con foro per l'appendimento.

One-piece rigid spatula, white abs material resistant to temperatures up to 100 ° C
Thin rectangular spoon, ergonomic handle with hole for hanging.



50SR340

Manico - Handle 239 mm
Total size 339x59 mm

Spatola rigida monopezzo, materiale ABS bianco resistente a temperature fino a 100°C
Cucchiaino rigido, tre lunghezze di manico con foro per l'appendimento.

One-piece rigid spatula, white ABS material resistant to temperatures up to 100°C
Rigid spoon, three lengths handles with hole for hanging.



SCM 30

Manico - Handle 195 mm
Total size 300x55 mm

SCM 35

Manico - Handle 240 mm
Total size 345x55 mm

SCM 40

Manico - Handle 295 mm
Total size 400x55 mm

Spatola rigida monopezzo, materiale ABS bianco resistente a temperature fino a 100°C
Cucchiaino liscio extra forte, punta stondata, manico ergonomico con foro per l'appendimento.

One-piece rigid spatula, white ABS material resistant to temperatures up to 100 ° C
Extra strong smooth spoon, with rounded tip, ergonomic handle with hole for hanging.



50SP300B

Manico - Handle 208 mm
Total size 300x48 mm

50SP350B

Manico - Handle 254 mm
Total size 350x53 mm

50SP400B

Manico - Handle 301 mm
Total size 400x58 mm

Spatola rigida monopezzo, materiale poliammide resistente a temperature fino a 220°C

One-piece rigid spatula, polyamide material resistant to temperatures up to 220 ° C



MEX 250

Manico - Handle 130 mm
Total size 250 mm

MEX 300

Manico - Handle 180 mm
Total size 300 mm

MEX 400

Manico - Handle 255 mm
Total size 400 mm

MEX 500

Manico - Handle 290 mm
Total size 500 mm

Spatole con cucchiaino cavo in gomma e manico in resistente materiale termoplastica.
Resistente a temperature fino a 70°C

Spatulas with rubber hollow spoon and handle in resistant thermoplastic material.
Resistant to temperatures up to 70°C



MSP 250

Manico - Handle 160 mm
Total size 250 mm

MSP 350

Manico - Handle 260 mm
Total size 350 mm

Spatole professionali rigide monopezzo, materiale ABS bianco resistente a temperature fino a 100°C
One-piece hard professional spatulas, white ABS material resistant to temperatures up to 100°C



50SA150B

Manico - Handle 180 mm
Total size 324x40 mm

50SA250B

Manico - Handle 180 mm
Total size 424x40 mm



50SL300B

Manico - Handle 156 mm
Total size 300x30 mm

50SL370B

Manico - Handle 161 mm
Total size 370x40 mm

SPATOLE IN ACCIAIO ST. STEEL SPATULAS

Spatole professionali con lama dritta o angolare in acciaio inox. Lama rigida per distribuire uniformemente anche ganache più dure ma flessibile per un glassaggio ottimale. Manico realizzato in robusta plastica, ergonomico e antiscivolo, progettato con speciale appoggio per il pollice, ideale per una presa confortevole e sicura.

Professional spatulas with stainless steel straight or angular blade. Sturdy blade to spread also harder ganache but flexible for optimal glazing. Handle made of resistant plastic, ergonomic and anti-slip, with a special thumb support, for a comfortable and secure grip.



50SPANG09

Manico - Handle 120 mm
Lama - Blade 20x90 mm

50SPANG16

Manico - Handle 130 mm
Lama - Blade 29x160 mm

50SPANG20

Manico - Handle 130 mm
Lama - Blade 37x205 mm



50SPA15

Manico - Handle 130 mm
Lama - Blade 27x155 mm

50SPA20

Manico - Handle 130 mm
Lama - Blade 29x200 mm

50SPA25

Manico - Handle 130 mm
Lama - Blade 37x254 mm

50SPA30

Manico - Handle 130 mm
Lama - Blade 45x308 mm

FRUSTE PROFESSIONALI PROFESSIONAL WHISKS

Interamente realizzata in acciaio inox, 8 robusti fili d. 2,2 mm
Resistente ad alte temperature.

Entirely made of stainless steel, 8 sturdy wires d. 2.2 mm
Resistant to high temperatures.



50FA01

Total size: 25 cm

50FA02

Total size: 30 cm

50FA03

Total size: 35 cm

50FA04

Total size: 40 cm

50FA05

Total size: 45 cm

50FA06

Total size: 50 cm

Manico antiscivolo in plastica rinforzata con fibra di vetro, 16 fili sottili in acciaio inox.
Resistente ad alte temperature.

Glass fiber reinforced plastic non-slip handle, 16 thin stainless steel wires.
Resistant to high temperatures.



TFRU 25

Total size: 25 cm
Filo - wire Ø 1,5 mm

TFRU 30

Total size: 30 cm
Filo - wire Ø 1,8 mm

TFRU 35

Total size: 35 cm
Filo - wire Ø 1,8 mm

TFRU 40

Total size: 40 cm
Filo - wire Ø 1,8 mm

TFRU 45

Total size: 45 cm
Filo - wire Ø 2 mm

TFRU 50

Total size: 50 cm
Filo - wire Ø 2 mm

Manico in plastica rinforzata con fibra di vetro, 16 fili sottili in acciaio inox.
Resistente ad alte temperature.

Glass fiber reinforced plastic handle, 16 thin stainless steel wires.
Resistant to high temperatures.



MFRU 25

Total size: 25 cm
Filo - wire Ø 1,5 mm

MFRU 30

Total size: 30 cm
Filo - wire Ø 1,8 mm

MFRU 35

Total size: 35 cm
Filo - wire Ø 1,8 mm

MFRU 40

Total size: 40 cm
Filo - wire Ø 1,8 mm

MFRU 45

Total size: 45 cm
Filo - wire Ø 2 mm

MFRU 50

Total size: 50 cm
Filo - wire Ø 2 mm

Professional Choco SCRAPERS



Le nuove raschie progettate e prodotte in Italia da Martellato rispondono alle esigenze dei cioccolatieri più attenti. Composte da una robusta **LAMA RIGIDA** in **ACCIAIO INOX** e proposte in differenti misure ed altezze per le diverse esigenze: **CORTA** per una maggiore sensibilità della mano o **LUNGA** per maggiore superficie di lavoro.

Il **MANICO SAGOMATO** in plastica **ANTISCIVOLO** è adatto a diverse impugnature e avvolge la lama per una completa sicurezza ed igiene.

The new scrapers designed and produced in Italy by Martellato meet the needs of the most demanding chocolatiers. Composed of a sturdy **STAINLESS STEEL RIGID BLADE** and proposed in different sizes and heights for different needs: **SHORT** for greater sensitivity of the hand or **LARGE** for greater working surface.

The **ANTI-SLIP SHAPED** plastic **HANDLE** is suitable for different grips and it wraps the blade for maximum safety and hygiene.



MODELLI - MODELS

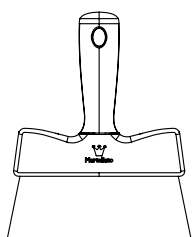

50RAS4

Total size: 180x145 mm
Manico - Handle: h 130x135,4 mm
Lama - Blade: 145 x h 50 mm

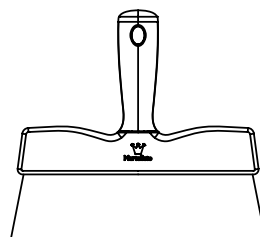

50RAS6

Total size: 180x200 mm
Manico - Handle: h 130x189,7 mm
Lama - Blade: 200 x h 50 mm

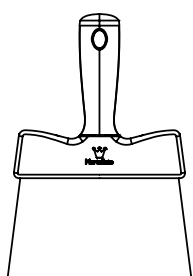

50RAS5

Total size: 210x145 mm
Manico - Handle: h 130x135,4 mm
Lama - Blade: 145 x h 80 mm

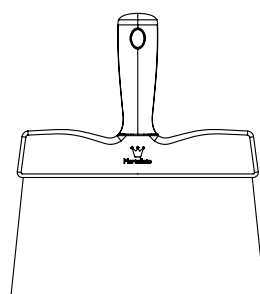

50RAS7

Total size: 225x200 mm
Manico - Handle: h 130x189,7 mm
Lama - Blade: 200 x h 95 mm

RASCHIE IN METALLO - METAL SCRAPERS

Raschie e spatole taglia impasto con lama in acciaio inox e manico in plastica.
Scrapers and spatulas for cutting dough with stainless steel blade and plastic handle



50RAS1 50RAS2
130 h105 175 h105

Lama Blade: Acciaio inox - Stainless steel
Spessore - Thickness 0,40 mm
Altezza - Height 80 mm



RAS 3
195 h145

Impugnatura in plastica - Plastic handle
Lama Blade: Acciaio inox - Stainless steel
Spessore - Thickness 0,50 mm
Altezza - Height 110 mm

TAGLIA IMPASTO - DOUGH CUTTERS

Spatole taglia impasto con impugnatura rotonda

Acciaio inox - Stainless steel
Altezza - Height 80 mm

Acciaio inox - Stainless steel
Altezza - Height 60 mm

Acciaio inox - Stainless steel
Altezza - Height 60 mm



RD105
105 x h105

RD125
125x h105



RC115
120 x h115



RC110
h110

RD150
150 x h105

RD175
175 x h105

RASCHIETTI IN PLASTICA - PLASTIC SCRAPERS

Raschietti in plastica per creme ed altri impasti. Confezioni 10 pezzi.

Plastic scrapers for creams and other doughs. Packs of 10 pcs.



145x95 MM

50RTD1

Rigido - Rigid



150x110 MM

50RTF1

Rigido - Rigid

50RTF2

Morbido - Soft



145x95 MM

50RTL1

Rigido - Rigid

50RTL2

Morbido - Soft



120x90 MM

50RTP1

Rigido - Rigid

50RTP2

Morbido - Soft



125x90 MM

50RTA1

Rigido - Rigid

50RTA2

Morbido - Soft



140x90 MM

50RTO1

Rigido - Rigid

50RTO2

Morbido - Soft



150x150 MM

50RTV1

Rigido - Rigid

50RTV2

Morbido - Soft



**BIG SIZE
215x130 MM**

50RTT1

Rigido - Rigid



**BIG SIZE
195x150 MM**

50RTS1

Rigido - Rigid

COLTELLI PROFESSIONALI PROFESSIONAL KNIVES

Robusta lama in acciaio inox temperato made in Italy. Manico ergonomico in polipropilene, materiale igienico, atossico e resistente in lavastoviglie. Confezione in blister sicuri.

Sturdy blade in tempered stainless steel, made in Italy. Ergonomic polypropylene handle, hygienic, non-toxic and dishwasher safe material. Secure blister packaging.



Cuoco 30 - Chef 30

50COL05

Lama - Blade: 300mm



Spelucchino 9 - Paring 9

50COL01

Lama - Blade: 90mm



Pasticceria 30 - Pastry 30

50COL02

Lama - Blade: 300mm



Cuoco 26 - Chef 26

50COL04

Lama - Blade: 260mm



Pasticceria 36 - Pastry 36

50COL03

Lama - Blade: 360mm



Salati e formaggi 26 - Salty and cheese 26

50COL06

Lama - Blade: 260mm



Pane e panettone 25 - Bread and panettone 25

50COL07

Lama - Blade: 250mm

PINZE CHEF CHEF TWEEZERS

Pinza professionale da cucina, caratterizzata dal design ergonomico, per una sicura e comoda maneggevolezza, che la rende adatta anche a decori e cibi più delicati.

Estremità antiscivolo, perfettamente allineate per afferrare con la massima precisione.
Pratica e comoda impugnatura con grip antiscivolo, garantisce una presa sicura e ferma.
Realizzata in acciaio inox di alta qualità, lavabile in lavastoviglie.

Professional cooking tweezer, the ergonomic design for safe and comfortable handling makes it suitable for delicate decorations and foods.

Non-slip ends, perfectly aligned, can precisely grab small detailed items with maximum precision without slipping.
Practical and comfortable thanks to the ridged handle that ensures a secure grip.
Made of high quality stainless steel, dishwasher safe.



50PI03 30 cm

50PI02 20 cm



50PI05 30 cm

50PI04 20 cm



50PI01 16 cm

GRATER & ZESTER

Ideale per cioccolato, formaggio, agrumi e altro.

Lama in **acciaio**, Manico **soft touch antiscivolo**, custodia protettiva.

Ideal for chocolate, cheese, citrus and more.

Stainless steel blade, **Non slip soft** handle, blade cover for safe storage.

Giallo - Yellow

50ZES01

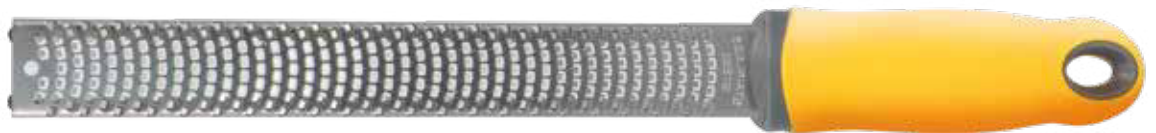

Rosso - Red

50ZES02



Nero - Black

50ZES03



PENNELLI - PASTRY BRUSHES

Pennello professionale per cucina: pennello multiuso con setole di alta qualità e impugnatura in plastica combinata a gomma, per una maggiore comodità. Resistente fino a 120°C. Lavabile in lavastoviglie. Made in Italy.

Professional cooking brush: multi-purpose brush with high quality bristles and comfortable handle in plastic and rubber. Heat resistant up to 120°C. Dishwasher safe. Made in Italy.



50PE30
30 mm

50PE40
40 mm

50PE50
50 mm

50PE60
60 mm

50PE70
70 mm

PINZE - PINCERS



PINZAX1
Pinze in acciaio inox
St. Steel pincers
190x17mm



PINZAX2
Pinze in acciaio inox
St. Steel pincers
190x36mm



PINZAX3
Pinze in acciaio inox
St. Steel pincers
190x38mm



PINZAX4
Pinze in acciaio inox
St. Steel pincers
190x58mm

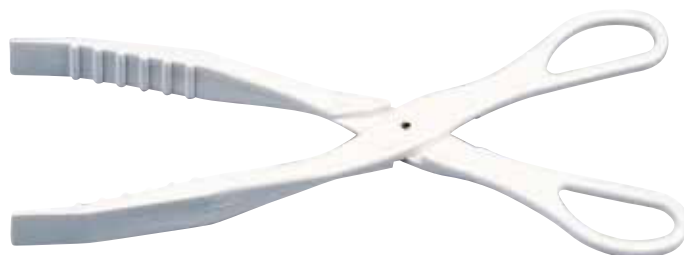

PINZA
Pinza in plastica
Plastic pincer
295x80mm

GRIGLIE - RACKS

Griglia di raffreddamento ideale per **glassare** e **raffreddare** torte. Resistente alle alte temperature.

Cromata, con piedini per facilitare il lavoro. Lavabile in lavastoviglie.

Cooling grid ideal for **cooling** and **glazing** cakes. Resistant to high temperatures.

Made of chromed iron with raised base to facilitate work. Dishwasher safe.



Ø30 CM
PR30

Ø40 CM
PR40

30x30 CM
PR30X30

50x50 CM
PR50X50

60x39 CM
PR40X60

Piedini più alti, perfetta per essere utilizzata con le teglie. Higher feet, perfect for use with trays.

SETACCI - SIEVES

Setacci in acciaio inox per farina. Trama setaccio 0,50 mm.

Stainless steel sieves for flour. Sieve weft 0,50 mm



Ø30 CM
SETAC30

Ø28 CM
SETAC28

Ø26 CM
SETAC26

Ø24 CM
SETAC24

Ø21 CM
SETAC21

Ø19 CM
SETAC19

Ø16 CM
SETAC16

Spargi Polvere

Diffusori a maglia fine con tappo a vite. Ideali per spolverare zucchero a velo e farina o aggiungere spezie e cacao. Il coperchio a rete fine diffonde il contenuto in modo leggero e uniforme, è sicuro e facile da rimuovere per riempire di nuovo il barattolo. Realizzati in acciaio inossidabile con una copertura di plastica ermetica per proteggere il contenuto.

Mesh Shaker

Fine mesh shakers with a screw cap. Ideal for sprinkling icing sugar and flour or adding spices and cocoa. The fine mesh lid spreads contents lightly and evenly, it is safe and easy to remove to refill the can. Made from stainless steel with an airtight plastic cover to protect the contents.



cap. 280 g
SETACIOK
Ø65 h90mm

cap. 450 g
SETACIOK2
Ø73 h120mm

TAGLIAPASTA ESTENSIBILE EXPANDABLE WHEELS CUTTER

Tagliapasta estensibile in acciaio, consente di tagliare in modo rapido e preciso strisce di impasti della stessa misura. Disponibile anche in versione doppia con lame dritte su un lato e alette scanalate sul retro. La distanza delle ruote è facilmente regolabile per ottenere strisce dai 10 ai 120 mm. Diametro ruota 5,5 cm. Le ruote possono essere bloccate nella posizione desiderata stringendo i dadi ad alette. Stoccaggio facile.

Extensible steel dough cutter, it allows to cut quickly and precisely strips of dough of the same size. Also available in double version with straight blades on one side and grooved blades on the back. The distance of the wheels is easily adjustable to obtain strips from 10 to 120 mm. Wheel diameter 5,5 cm. The wheels can be locked in the desired position by tightening the wing nuts. Easy storage.



5 Lame lisce - Straight Blades
ROTAPINOX 5 P



5 Lame ondulate - Curved Blades
ROTAPINOX 5 O



5 Lame ondulate - Curved Blades
5 Lame lisce - Straight Blades
ROTINOX 5 P/O



7 Lame lisce - Straight Blades
ROTAPINOX 7 P



7 Lame ondulate - Curved Blades
ROTAPINOX 7 O



7 Lame ondulate - Curved Blades
7 Lame lisce - Straight Blades
ROTINOX 7 P/O

RULLI FORAPASTA - CUTTING DOCKER

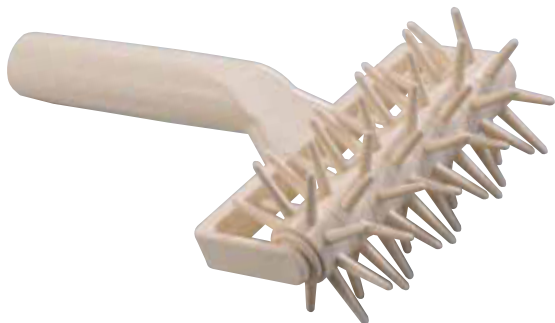

Rullo in plastica forapasta
Plastic spiked roller

6 CM

RFP 6

12 CM

RFP 12



Rullo in plastica per losanghe
Plastic lattice cutting rollers

6 CM

RPL 6

12 CM

RPL 12

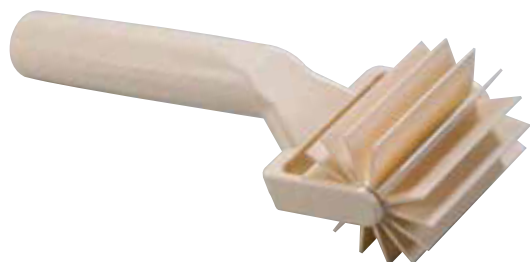

Rullo in plastica a lamelle
Plastic cutting roller

6 CM

RPS 6



Rullo forapasta in alluminio
Aluminum spiked roller

12 CM

RFP12INOX



Rullo in acciaio inox per losanghe
St. Steel lattice cutting roller

12 CM

RPL12INOX

Distanza tra lame 7 mm

Distance between blade 7 mm



Rotella tagliapasta
Pastry cutters

Ø 5,5 CM

PC55

Ø 6,5 CM

PC65

Ø 10 CM

PC100

Ø 12 CM

PC120

TAGLIA CROISSANT - CROISSANT CUTTERS

Rulli taglia croissant triangolari in acciaio inox con manico ergonomico in plastica.
Triangular stainless steel croissant cutting rollers with ergonomic plastic handle.

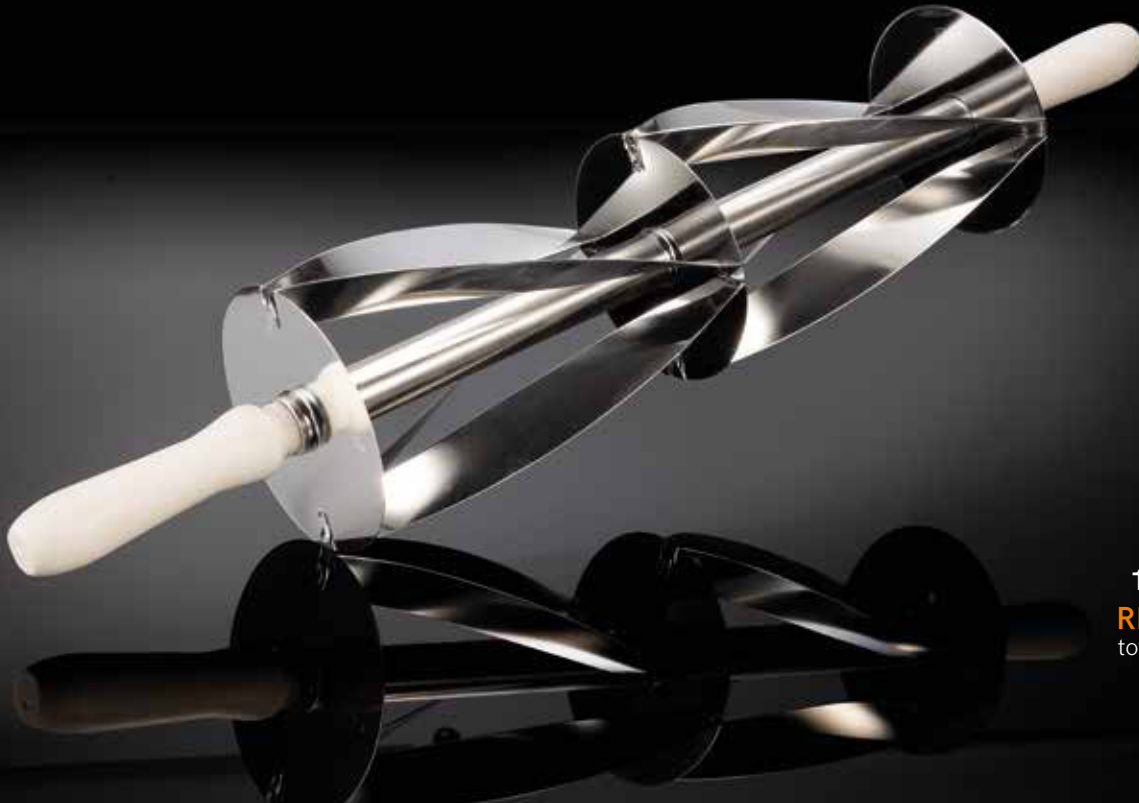

180x200 mm
RDC180X200
total size: 660 mm



misura di taglio **97x210 mm**
RSC97X210
total size: 460 mm

misura di taglio **180x140 mm**
RSC180X140
total size: 400 mm

misura di taglio **96x153 mm**
RSC96X153
total size: 410 mm

misura di taglio **180x200 mm**
RSC180X200
total size: 450 mm

misura di taglio **70x100 mm**
RSC70X100
total size: 360 mm

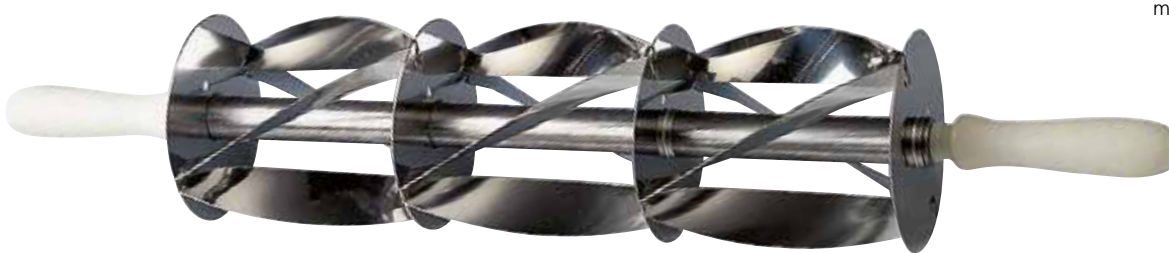

misura di taglio **180x200 mm**
RTC180X200
total size: 860 mm



La **misura del taglio** è riferita al triangolo di pasta.
The measure of the cut refers to the triangle of dough.

RULLI - ROLLING PINS

Rulli di legno Wooden rolling pins



50 CM RL 1 Ø 7CM	50 CM RL 2 Ø 8CM
60 CM RL 3 Ø 7CM	60 CM RL 4 Ø 8CM

Rulli di legno girevoli Revolving wooden rolling pins



30 CM RLS30 Ø 8CM	35 CM RLS35 Ø 8CM	40 CM RLS40 Ø 8CM
45 CM RLS45 Ø 8CM	50 CM RLS50 Ø 8CM	60 CM RLS60 Ø 8CM

Rulli in polietilene Polyethylene rolling pins



30 CM RLS50 PE Ø 7cm	40 CM RLS60 PE Ø 7cm	50 CM RLS70 PE Ø 7cm
--	--	--

Rulli in polietilene ideali per pasta di zucchero e cioccolato Polyethylene rolling pins for sugar paste and chocolate



23 CM 40-W021 Ø 2,5cm	35 CM 40-W154 Ø 4,5cm	50 CM 40-W022 Ø 4,5cm
---	---	---



Rullo taglia grissini in polietilene Breadstick cutter made of polyethylene

Per ottenere strisce di marzipane, pastafrolla e altri impasti.
To make marzipan, shortcrust pastry or other mixtures stripes.

15 MM
RLT 15
*19,5cm



QUICK DISKS

Utilizzate per ottimizzare produzione, le dime forate sono ideali per produrre perfetti dischi di pan di spagna, meringhe ed altri impasti, senza sprechi ed in poco tempo. Realizzate in plastica alimentare, resistente e lavabile in lavastoviglie, in diversi diametri.

Used to optimise production, the perforated frames are ideal for producing perfect sponge cake discs, meringues and other doughs, without waste and in a short time. Made of food-grade plastic, resistant and dishwasher-safe, in different diameters.

Spessore 8 mm - 8 mm thick

Ø 13,5 CM
50DF138
Prod 8 pcs

Ø 15,5 CM
50DF158
Prod 6 pcs

Ø 17,5 CM
50DF178
Prod 6 pcs

Ø 19,5 CM
50DF198
Prod 4 pcs

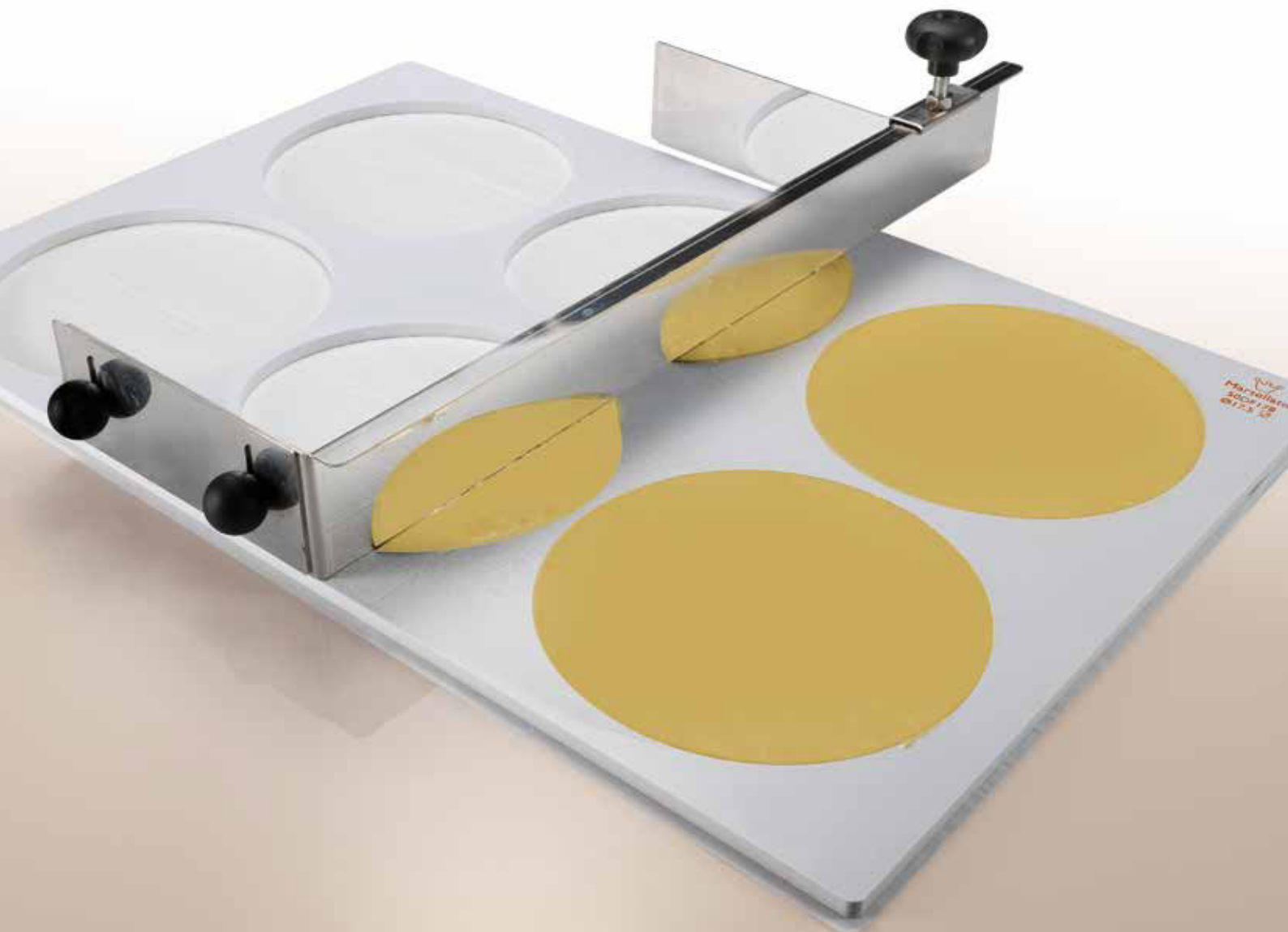

RAPLETTE

Raplette regolabile che consente di stendere e livellare in modo veloce, preciso ed uniforme impasti morbidi e cioccolato (anche multi-strato). Realizzata in resistente acciaio inox, conferisce al prodotto le dimensioni desiderate. La larghezza massima di stesura è 40 cm, lo spessore è variabile da 0.1 a 1.8 cm.

Adjustable Raplette for fast, precise and uniform spreading and levelling of soft dough and chocolate (also multi-layer). Made of resistant stainless steel, it gives the product the desired dimensions. The maximum spreading width is 40 cm, the thickness is variable from 0.1 to 1.8 cm.

SPB SPECIAL
MISURA MASSIMA
MAXIMUM SIZE

40CM

Misura esterna
External Size: 50x18 h 6



RAPLETTE

Raplette in plastica - Plastic spatulas

Raplette in plastica, consentono di stendere e livellare in modo veloce, preciso ed uniforme vari impasti. Perfette per lo spostamento di cremi sulle chitarre.

Plastic raplette, allow you to spread and level various mixtures quickly, precisely and evenly. Perfect for transferring cremi on guitars.



30 CM

50SPB30

x cod: 50TLMINI



43 CM

50SPB43

x cod: 50TLSPECIAL

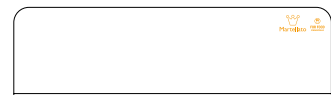

42 CM

CSMSPB40

x cod: CSM040

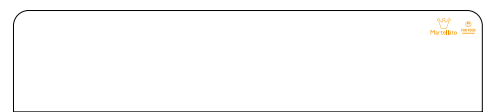

62 CM

CSMSPB60

x cod: CSM060

CANNOLI MOULDS

Stampi in acciaio per la produzione di cannoli.
Stainless steel moulds to make cannoli.



22x140 mm
50CI22X14
10 pcs



16x200 mm
50CI16X20
12 pcs



12x200 mm
50CI12X20
12 pcs



Ø30x120 mm
50CO30X12
12 pcs



Ø35x140 mm
50CO35X14
12 pcs



Ø40x160 mm
50CO40X16
12 pcs

Stampi in plastica speciale per la
produzione di cannoli.
Special plastic mould to make
cannoli.



Ø30x120 mm
CANNOLO
10 pcs

CARTA FORNO - BAKING PAPER

Carta da Forno Professionale antiaderente e resistente
alle alte temperature - Bisiliconata
Adatto per forno tradizionale e microonde - Multiuso

Professional Baking Paper non-stick and high
temperatures resistant - silicone on both sides
Suitable for traditional and microwave oven - Multiuse

60x40 CM
51CF6040
500 fogli - sheets



SEGNAPORZIONI - CAKE MARKERS

Porzionatori per torte utilizzabili in entrambi i lati.
Double faced cake portion markers.



Segnaporzioni Ø 25 cm in plastica per torte
Plastic cake markers Ø 25 cm

8-12 portions

PPT 8/12

12-16 portions

PPT 12/16

14-16 portions

PPT 14/16

12-18 portions

PPT 12/18

14-18 portions

PPT 14/18

12 portions

PPT 12



Segnaporzioni Ø 33 cm in acciaio per torte
St. Steel Cake markers Ø 33 cm

8 portions

PPT8X

10 portions

PPT10X

12 portions

PPT12X

14 portions

PPT14X

16 portions

PPT16X

18 portions

PPT18X



Griglia Tagliapasta per Crostate
Cutter for Tarts

Griglia per il taglio regolare della pasta in modo rapido e semplice.

Grid for regular cutting of dough in a quick and easy way.

Ø30 cm

DECOR 30

LIRA - CAKE SLICER



Lira per pan di spagna
Sponge cake slicer

CS3

460 mm

3 lame altezza variabile: da 10 a 90 mm.

3 variable height blades: from 10 until 90 mm.

CSL

lama di ricambio - spare blade

SET TAGLIA PASTA - CUTTERS KIT

Set tagliapasta in acciaio inox proposti in kit multi misura.
Stainless steel cutters set offered in multi size kits.

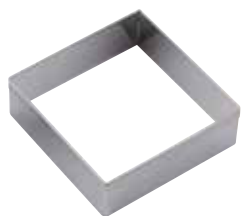

CUT5L7

7 pcs
65 - 57 - 50 - 45 - 40 - 35
- 27

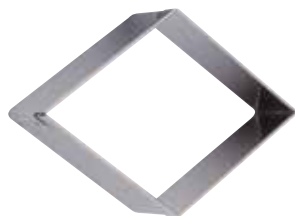

CUT6L7

7 pcs
90x60 - 80x50 - 70x45 -
60x40
50x30 - 40x25 - 30x20



CUT22L7

7 pcs
65x50 - 60x45 - 55x40
- 50x35 47x32 - 43x28 -
37x25



CUT3L7

7 pcs
75 - 67 - 63 - 57 - 52 - 47
- 42



CUT28L7

7 pcs
100x50 - 90x45 - 85x43 -
75x40
70x35 - 60x30 - 55x25



CUT8L7

7 pcs
90x60 - 80x50 - 70x45 -
65x40
55x33 - 45x25 - 35x20



CUT9L7

7 pcs
90x60 - 85x55 - 75x50
- 65x43 55x40 - 50x32 -
40x25



CUT16L7

7 pcs
80 - 75 - 67 - 60 - 50 - 40
- 33



CUT26L7

7 pcs
90 - 80 - 70 - 55 - 40 - 35
- 30



CUT18L7

7 pcs
90x65 - 80x60 - 70x50
- 55x40 45x30 - 33x23 -
25x18



CUT31L7

7 pcs
90 - 80 - 70 - 60 - 50 - 40
- 30

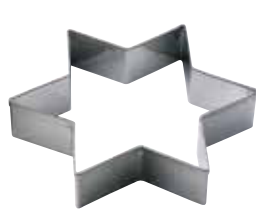

CUT10L9

9 pcs
37 - 51 - 66 - 82 - 96 - 110
125 - 137 - 150



CUT12L7

7 pcs
90 - 80 - 65 - 53 - 42 - 55
- 30



CUT20L7

7 pcs
90 - 75 - 70 - 55 - 45 - 40
- 25



CUT15L7

7 pcs
86x45 - 76x38 - 68x33
- 61x30 55x25 - 49x21 -
42x17



Ovali lisci
Smooth Oval

7 pcs
CUT2L7

85x70-75x65-65x55-55x45
45x35-35x25-23x18

9 pcs
CUT2L9

27x34-33x46-42x57-51x68
62x78-71x87-82x97-92x107
102x117



Tondi lisci
Smooth Round

7 pcs
CUT1L7

30-40-50-60
70-80-90

12 pcs
CUT1L12

30-40-50-60-70-80-90
100-110-120-130-140

Tondi Ondulati
Wavy Round

9 pcs
CUT1F9

30-40-50-60-70-80
90-100-110



9 PCS
CUT1L9

30-40-50-60-70
80-90-100-110

16 PCS
CUT1L16

20-30-40-50-60-70
75-80-85-90-95-100
110-120-125-140

12 pcs
CUT1F12

30-40-50-60
70-80-90-100
110-120-130-140



Cuori lisci
Smooth Heart

7 pcs
CUT7L7

35-40-45-55-65-75-85

12 pcs
CUT7L12

36-43-52-60-70-80-90-100
110-120-130-140

Cuori Ondulati
Wavy Heart

9 pcs
CUT7F9

60-70-80-90-100
110-120-130-140

Taglia pasta in acciaio inox, con manico.
Stainless steel cutter, with handle.

Ondulati - Wavy

CUT1FM12

Ø 120 x h20 mm

CUT1FM14

Ø 140 x h20 mm



Lisci - Smooth

CUT1LM12

Ø 120 x h20 mm

CUT1LM14

Ø 140 x h20 mm



MINI TAGLIA PASTA - MINI CUTTERS



Set tagliapasta - Praline cutters set

PRA 9

Tagliapasta inox per praline di marzipane
St. Steel marzipan pralines cutters set
H 50 mm



35x20



30x19



40x23



25x25



35x35



35x25



40x27



40x23



Ø28

GRIGLIE TAGLIAPASTA PLASTIC CUTTER GRIDS

Placca in plastica per la produzione di soggetti tematici di pasta frolla, sfoglia ed altri impasti.

Ideale per la preparazione di biscetteria dolce e salata.

Plastic grid for cutting shortcrust pastry, puff pastry and other doughs. Ideal for preparing sweet and savory biscuits.

Misure-Size: 60x40cm

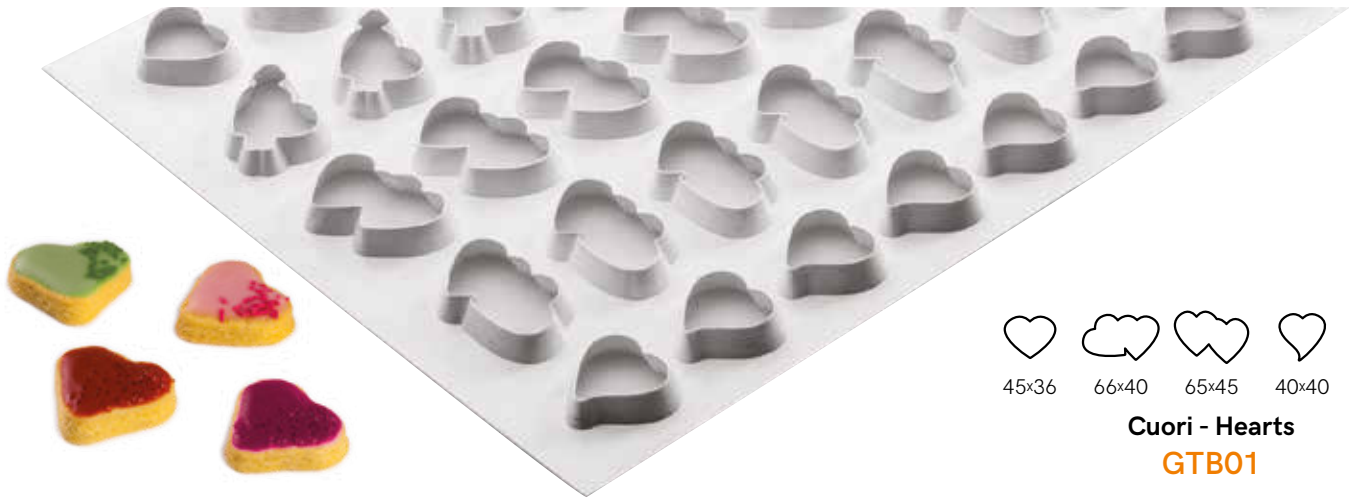

Cuori - Hearts

GTB01

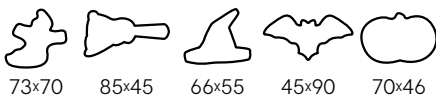

Halloween

GTB02

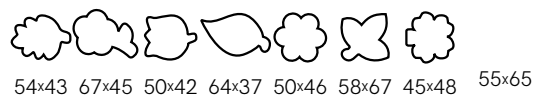

Fiori Foglie - Flowers Leaves

GTB05



Anim. domestici - Pets

GTB06

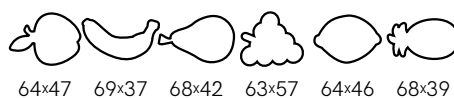

Frutta - Fruit

GTB08

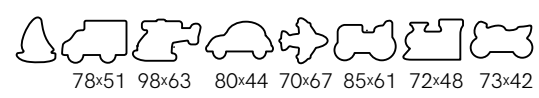

Trasporti - Transport

GTB10



58x46

50x46

50x52

50x50

Carte da gioco - Cards

GTB11



Ø39 - 40pcs

Tondo festonato
Wavy round

GTB15



42x38 - 35pcs

Stella - Star

GTB17



40x40 - 35pcs

Croce Festonata
Wavy Cross

GTB18



39x36 - 40pcs

Cuore - Heart

GTB19



Dolce San Martino

SMA320

320x340 mm

SMA260

260x280 mm

SMA180

180x200 mm

SMA110

110x125 mm



Biscotti San Martino

GTB13

100x77mm



FLACONI - BOTTLES



**Flacone per bagna e sciroppo
con tappo e copritappo**
Syrup soaker bottle with cap

1000ml
50FL00C
100x56 - h275 mm

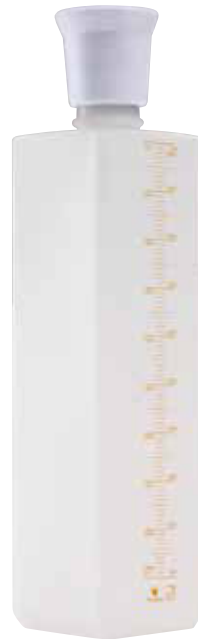

Flacone per bagna e sciroppo
Syrup soaker bottle

1000ml
FLACONE
70x70 - h270 mm

Flacone per bagna e sciroppo
Syrup soaker bottle

1000ml
50FL00
100x56 - h275 mm



Flacone annaffiatore per bagna
Syrup soaking bottle

1000ml **500ml**
FLAN1 **50FLAN2**
Ø85 h 250 mm



Flaconi nebulizzatori
Spraying bottles

1000 ml **500 ml**
FLACONE2 **50FLAN2T**
70x70 - h300 mm



Flacone dosatore
Completo di tappo con beccuccio.

Dosage bottle
Complete with cap and nozzle.

100 ml **250 ml**
BO100N **BO250N**
Ø40 - h138 mm Ø50 - h194 mm
500 ml **1000 ml**
BO500N **BO1000N**
Ø60 - h253 mm Ø79 - h283 mm

Porta Flacone - Bottles holder

PORTFLACONE
250x110 h 80 mm
Cap. 3 cod. FLACONE
Bottles not included



DIME - TEMPLATES

Dime di taglio in plastica trasparente per il taglio in strisce regolari di pasta frolla, cioccolato e biscuit.
Transparent plastic grids for cutting regular strips of shortcrust pastry, chocolate and biscuit.

50GD0022

Griglia speciale per tagli da 2,2 cm.
Special grid to cut 2,2 cm.

50GD0027

Griglia speciale per tagli da 2,7 cm.
Special grid to cut 2,7 cm.

50GD0037

Griglia speciale per tagli da 3,7 cm.
Special grid to cut 3,7 cm.

50GD2040

Griglia speciale per tagli da 2 e 4 cm.
Special grid to cut 2 and 4 cm.

50GD3060

Griglia speciale per tagli da 3 e 6 cm.
Special grid to cut 3 and 6 cm.

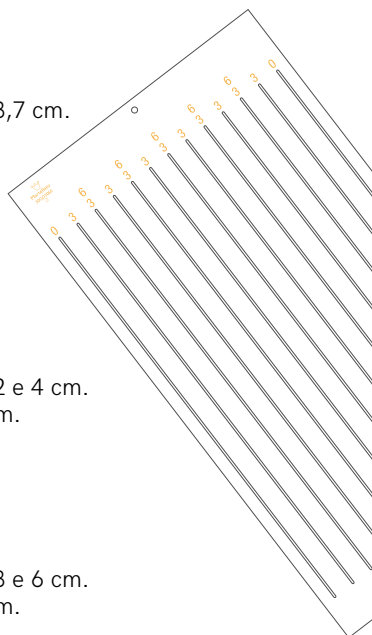

Righelli trasparenti in plastica - Plastic transparent rulers

RIGA64

5 Divisioni da 12 cm e 7 divisioni da 8 cm.
Five 12 cm divisions and seven 8cm divisions.

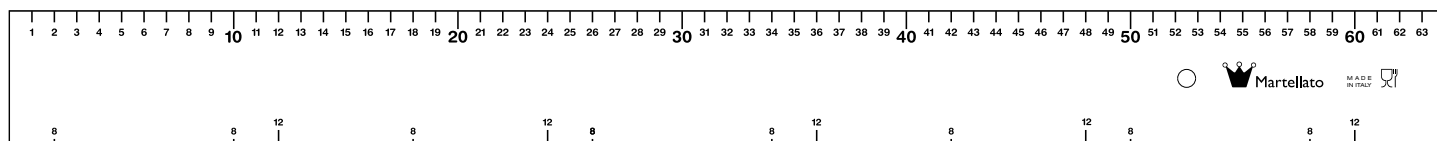

TAGLIERI - CUTTING BOARD

Taglieri Cutting board

Piano di lavoro in plastica
Plastic worktop

TAG5
50x30 h3 cm



TEGLIE FORNO - BAKING TRAY

Servizio teflonatura su richiesta
On demand tefloning service

TEGLIE ALLUMINIO ALUMINIUM TRAYS



53TA60404

2cm - 60x40 cm

Teglia in **alluminio** con **4 bordi**, spessore 1,5 mm
Aluminium baking tray with **4 edges**, 1,5 mm thick

53TA60402

2cm - 60x40 cm

Teglia in **alluminio** con **2 bordi**, spessore 1,5 mm
Aluminium baking tray with **2 edges**, 1,5 mm thick

TEGLIE FORATE ALLUMINIO PERFORATED ALUMINIUM TRAYS



53TAF60404

2cm - 60x40 cm

Teglia forata in **alluminio** con **4 bordi**, spessore 1,5 mm
Flat **perforated aluminium** baking tray with **4 edges**, 1,5 mm thick

53TAF40304

2cm - 40x30 cm

Teglia forata in **alluminio** con **4 bordi**, spessore 1,5 mm
Flat **perforated aluminium** baking tray with **4 edges**, 1,5 mm thick

53TAF40302

2cm - 40x30 cm

Teglia forata in **alluminio** con **2 bordi**, spessore 1,5 mm
Flat **perforated aluminium** baking tray with **4 edges**, 1,5 mm thick

TEGLIE ALLUMINATE ALUMINIZED TRAYS



53TL60404

2cm - 60x40 cm

Teglia **alluminata** con **4 bordi**, spessore 0,8 mm
Made of aluminized sheet with **4 edges**, 0,8 mm thick

53TL60402

2cm - 60x40 cm

Teglia **alluminata** con **2 bordi**, spessore 0,8 mm
Made of aluminized sheet with **2 edges**, 0,8 mm thick

TAPPETI COTTURA - BAKING MATS

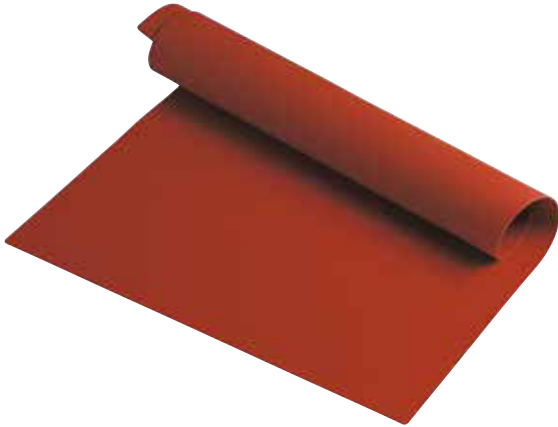

Tappeti antiaderenti in silicone per cottura e surgelazione di qualsiasi prodotto alimentare.

Non-stick silicon mats for baking and freezing every kind of food.

39,5x59,5 CM
SILICOPAT1/R

30X40 CM
SILICOPAT7/R

27x42 CM
SILICOPAT5/R

31x51 CM
SILICOPAT2/R

36x43 CM
SILICOPAT6/R



Tappeti antiaderenti in silicone con fibra di vetro per cottura e surgelazione di qualsiasi prodotto alimentare.

Ideali per la lavorazione dello zucchero.

Non-stick silicon mats with glass fibres for baking and freezing every kind of food. **Ideal to work with sugar.**

59x39 CM
SILICOPAT1/B

31x51 CM
SILICOPAT2/B

62X42 CM
SILICOPAT3/B

79x59 CM
SILICOPAT4/B



Tappetino antiaderente in teflon.
Non stick teflon mat.

59X39 CM
TEFLONPAT

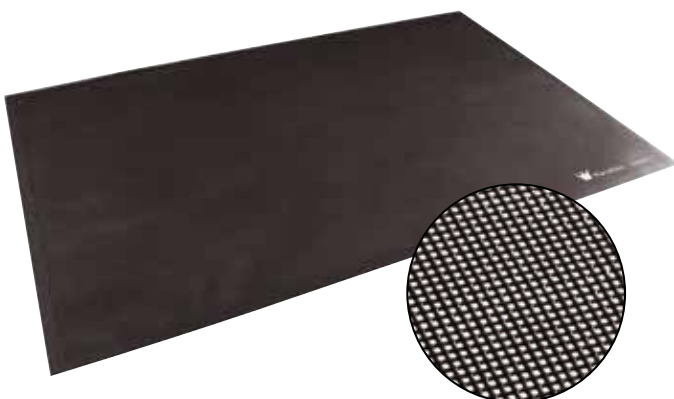

Tappeti silicone microforato con fibra di vetro.
Silicone mats perforated with glass fibres.

38,5x58,5 CM
MICROMAT60

38,5x28,5 CM
MICROMAT30

CARAFFE - CARAFES



**Caraffa graduata MAXI in plastica di alta qualità.
MAXI graduated carafe made of high quality plastic.**

Impugnatura chiusa rinforzata, plastica translucida,
scala graduata in rilievo.
Resistente agli urti anche alle basse temperature.

Reinforced closed handle, translucent plastic,
graduated scale in relief.
Impact resistant even at low temperatures.



**Caraffa con coperchio
Carafe with lid**

CFTRA6C - 6000 ML
coperchio paraschizzi apribile
openable splash protection lid

**Caraffa
Carafe**

CFTRA6 - 6000 ML



**Caraffe graduate plastica trasparente
Transparent plastic measuring cups**

Caraffa graduata in plastica impugnatura aperta.
Plastica trasparente - impilabili.

Graduated plastic carafe with open handle.
Transparent plastic - stackable.

500 ml

CFTRA1

1000 ml

CFTRA2

2000 ml

CFTRA3

3000 ml

CFTRA4

SESSOLE - FLOUR SCOOPS

Pratiche sessole in plastica con base piatta, per conferire stabilità anche se appoggiate, adatte anche a liquidi.
Practical plastic bailers with a flat base, in order to provide stability even if laid, suitable for liquids as well.



125 ml

SES 100

Size: 185x65 mm
Spoon: 110x65 mm

250 ml

SES 250

Size: 250x90 mm
Spoon: 150x90 mm

512 ml

SES 500

Size: 310x117 mm
Spoon: 190x117 mm

857 ml

SES 800

Size: 345x145 mm
Spoon: 230x145 mm

1520 ml

SES 1500

Size: 400x175 mm
Spoon: 275x175 mm

CIOTOLE - BOWLS

Ciotola in policarbonato trasparente
Transparent polycarbonate bowls



0,4 L

52BO13PC

Ø 13 cm

1 L

52BO17PC

Ø 17 cm

2,5 L

52BO23PC

Ø 23 cm

4 L

52BO28PC

Ø 28 cm

8 L

52BO32PC

Ø 32 cm

10 L

52BO38PC

Ø 38 cm

Ciotola in polipropilene bianco
White polypropylene bowls



0,4 L

52BO13PP

Ø 13 cm

1 L

52BO17PP

Ø 17 cm

2,5 L

52BO23PP

Ø 23 cm

4 L

52BO28PP

Ø 28 cm

8 L

52BO32PP

Ø 32 cm

10 L

52BO38PP

Ø 38 cm

STAMPI PANE - BREAD MOULDS



Stampo per pane kaiser
Kaiser bread mould

STPTA 6
Ø8cm



Stampo per pane kaiser
Kaiser bread mould

STPTA 7
Ø8cm



Stampo per pane girella
Girella bread mould

STPTA 8
Ø8cm



Stampo per pane zucca
Pumpkin bread mould

STPZ
Ø8cm

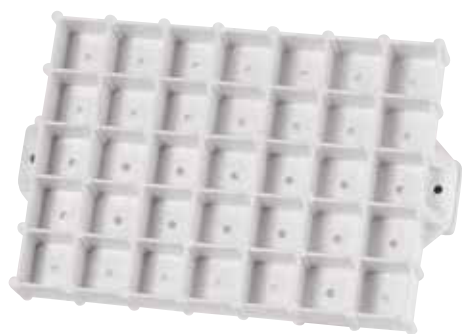

Stampo pane tartaruga quadrato
Square turtle bread mould

STPTA 1
14x10cm

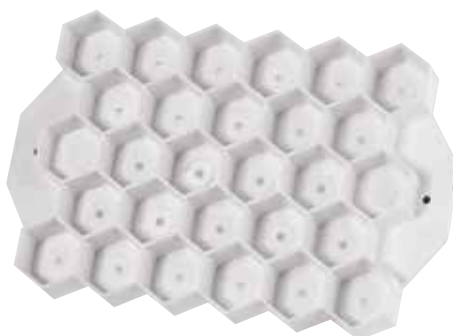

Stampo pane tartaruga esagonale
Hexagonal turtle bread mould

STPTA 2
14x11cm



Stampo pane margherita
Marguerite bread mould

STPTA 5
Ø12,5cm



Stampo pane sole
Sun bread mould

STPTA 3
Ø12,5cm



Marcatore girevole per pane kaiser
Kaiser bread revolving marker

STPK
L 200 - Ø6cm

TELI COPRI IMPASTO DOUGH PROOFING SHEETS

Ideali per proteggere gli impasti durante la lievitazione conservando il giusto livello di umidità, riparando da agenti esterni ed aria. I teli sono utili per coprire i prodotti da forno durante il raffreddamento in modo da trattenere gli aromi che si sprigionano subito dopo la cottura. Realizzati in **trasparente polietilene alimentare**, destinati ad uso professionale, garantiscono la massima igiene, praticità d'uso e durata nel tempo.

Ideal for protecting doughs during leavening and maintaining the right level of humidity, protecting from external agents and air. The sheets are also useful for covering baked goods during cooling in order to retain the aromas that are released immediately after cooking. Made of **transparent food-grade polyethylene**, for professional use, they guarantee maximum hygiene, practical use and durability.

55TP6080

60X80CM

PACK 50 pcs - 70 My

55TP22080

200X80CM

PACK 50 pcs - 70 My



CESTINI PANE - BREAD BASKET

Cestini per lievitazione
Leavening bread baskets



Cap. gr	Size cm	Code
1500	Ø25	BASKET 205
1000	Ø21,5	BASKET 206
500	Ø18	BASKET 207
250	Ø13	BASKET 208

Cap. gr	Size cm	Code
1500	40x14	BASKET 105
1000	35x13	BASKET 106
500	27x12	BASKET 107

Cap. gr	Size cm	Code
1000	29x18	BASKET 102
500	22x14	BASKET 103
750	24x14	BASKET 108

TAGLIERINI - BREAD CUTTERS



Lama liscia - Plain blade
INOX

CUTTER 7
9cm



Lama ondulata - Fluted blade
INOX

CUTTER 8
9cm



Lama liscia - Plain blade
INOX

50COL50
7cm



Coltellino plastica lama girevole
Plastic cutter with rotating blade

CUTTER 4



Coltellino doppia lama ondulata
Cutter with double fluted blade

CUTTER 12
8cm



Lama ondulata
Fluted blade
INOX

50COL51
8cm



Coltellino plastica lama fissa
Plastic cutter with fixed blade

CUTTER 1



Lama segna pane
Marking bread blade

CUTTER 15



Coltellino con protezione lama
Cutter with blade cover

CUTTER14



Cutter baguette con manico plastica
Plastic cutter for bread

CUTTER13
kit 2 pcs



Coltellino plastica lama fissa
Plastic cutter with fixed blade

CUTTER5
1 Cutter + 25 lame/blades



Coltellino plastica lama fissa
Plastic cutter with fixed blade

CUTTER5/A
1 Cutter

SPAZZOLE - BRUSHES



Spazzola per farina
Flour brush

SPZ SE
400x40 mm
Temp. MAX 90° C

con setole naturali.
with natural bristles.



Spazzola in Plastica
Plastic brush

SPZ PL3
400x40 mm
Temp. MAX 130° C

con setole in poliestere.
with polyester bristles.



Spazzola Pane
Bread brush

SPZ PL1
210x65 mm
Temp. MAX 130° C

con setole in poliestere.
with polyester bristles.



Spazzola inox
Inox brush

SPZ INOX
145x55 mm

con setole in acciaio inox.
with stainless steel bristles.

GUANTI - GLOVES



Manopole in pelle - Leather mitten

GL1

380x150 mm

Resistenti fino ad una temperatura di ca. 250°C
Realizzate in pelle morbida e rivestimento interno di gomma piuma.

Heat resistant up to a temperature of approx. 250 ° C
Made of soft leather and foam inner lining

CE marking: II CAT. EN 388:2016 EN 407:2004



Manopole in pelle polso lungo - Long leather mitten

GL2

450x150 mm

Resistenti fino ad una temperatura di ca. 250°C
Ideali per la protezione della mano e dell'avanbraccio.
Realizzate in pelle morbida e rivestimento interno di cotone.

Heat resistant up to a temperature of approx. 250°C
Ideal for arm and hand protection.
Made of soft leather and inner lining of cotton.

CE marking: II CAT. EN 388:2016 EN 407:2004



Guanti in pelle a tre dita - Three-fingers leather oven gloves

GL3

340x140 mm

Resistenti fino ad una temperatura di ca. 250°C
Realizzati in pelle morbida e rivestimento interno di cotone.

Heat resistant up to a temperature of approx. 250 ° C
Made of soft leather and inner lining of cotton.

CE marking: II CAT. EN 388:2016 EN 407:2004



Manopole in cotone Short cotton mitten

GL10

100% cotone - cotton
27x15cm



Manopole lunghe in cotone Long cotton mitten

GL11

100% cotone - cotton
34x15cm



Presine per forno in pelle Oven leather pot holder

GL25PRE

25x35cm

GL18PRE

18x25cm

SEGNAPREZZI - PRICE CARDS



SEG001N
70x40mm - 15 pcs



SEG002N
60x80mm - 25 pcs



SEG003N
45x65mm - 30 pcs

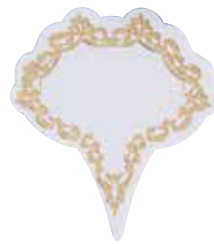

SEG004N
35x40mm - 30 pcs



SEG005N
55x80mm - 50 pcs



SEG006N
60x80mm - 40 pcs



SEG008N
60x90mm - 25 pcs



SEG015N
60x50mm - 50 pcs



SEG024N
55x92mm - 25 pcs



SEG025N
62x86mm - 25 pcs



SEG027N
65x62mm - 15 pcs

CAPPELLI IN CARTA - PAPER HATS



h 250 mm
CAP2B
10 pcs



h 200 mm
CAP 3
10 pcs Regolabile - Adjustable



280x h85mm
CAP 4
25 pcs

CAKE BOARD



PRATICHE E UTILI TAVOLE MULTIFUNZIONE

Adatte allo spostamento e stoccaggio di torte ed altri prodotti.

Realizzate in materiale plastico di alta qualità e resistenza.

Non assorbono né odori, né umidità.

Disponibili in diverse misure e forme, per adattarsi alle molteplici esigenze.

Disponibili anche con piedini a sfera Ø 25 mm

Altre misure forme realizzabili su richiesta.



MULTI-PURPOSE BOARDS

Suitable for moving and store cakes and other products.

Made of a high quality and resistant plastic material.

They do not absorb smells or moisture.

Il materiale con il quale sono realizzati proviene parzialmente da plastica riciclata.
The material used is partially composed of recycled plastic.



Available in many sizes and shapes, suitable for different needs.

Available with or without plastic feet Ø 25 mm

Other shapes and sizes on request.



Copertura monouso per carrelli
Disposable trolley cover

50CP01

GN 2/1 60x40 h 180 cm
roll 200 pcs - 20 micron

Copertura carrelli
Trolleys Cover



Staffa inox da muro porta rotolo
Stainless steel wall bracket for roll holder

50ST01

Staffa porta rotolo 50CP01



Rettangolare - Rectangular

Rotonda - Round

Quadrata - Square

Misura Size cm	Piedini Feet	Codice Code
40x60	5	TAV 40X60 C/P
59x39	no	TAV 59X39
40x60	no	TAV60X40
50x60	5	TAV 50X60 C/P
50x60	no	TAV 50X60 PIA
60x70	9	TAV 60X70 C/P
60x70	no	TAV 60X70 PIA
60x80	12	TAV 60X80 C/P
60x80	no	TAV 60X80 PIA

Misura Size cm	Piedini Feet	Codice Code
Ø 40	4	TAV D. 40 C/P
Ø 40	no	TAV D. 40 PIA
Ø 50	5	TAV D. 50 C/P
Ø 50	no	TAV D. 50 PIA
Ø 60	5	TAV D. 60 C/P
Ø 60	no	TAV D. 60 PIA
Ø 70	9	TAV D. 70 C/P
Ø 70	no	TAV D. 70 PIA
Ø 80	9	TAV D. 80 C/P
Ø 80	no	TAV D. 80 PIA
Ø 90	9	TAV D. 90 C/P
Ø 90	no	TAV D. 90 PIA
Ø 100	13	TAV D. 100 C/P
Ø 100	no	TAV D. 100 PIA

Misura Size cm	Piedini Feet	Codice Code
50x50	4	TAV 50 X 50 C/P
50x50	no	TAV 50 X 50 PIA
60x60	5	TAV 60 X 60 C/P
60x60	no	TAV 60 X 60 PIA
70x70	9	TAV 70 X 70 C/P
70x70	no	TAV 70 X 70 PIA

pedino
plastic feet
Ø 25 mm

C/P con piedini
with feet
PIA senza piedini
without feet

Sottotorta rotondi in plastica rigida - Spessore 3 mm
Hard plastic round cake boards - Thickness 3 mm



Kit completo - Complete kit

SET DISK

8 pcs (PST)

tutte le misure - alle the size

Misure singole - Single size

3 pcs (PST)

- Ø 20 **50DI20**
- Ø 22 **50DI22**
- Ø 24 **50DI24**
- Ø 26 **50DI26**
- Ø 28 **50DI28**
- Ø 30 **50DI30**
- Ø 32 **50DI32**
- Ø 34 **50DI34**

**Rotondi
Round**

Size cm	Codice Code
Ø 16	40-W056
Ø 18	40-W057
Ø 20	40-W058
Ø 22	40-W059
Ø 24	40-W060
Ø 26	40-W061
Ø 28	40-W062

**Rotondi
Round**

Size cm	Codice Code
Ø 30	40-W063
Ø 32	40-W064
Ø 40	40-W065

Sottotorta in plastica cannettata
Cannulated plastic cake boards
20 pcs



DECORATION



SUGAR LAMP

Lampada per Zucchero

Ideata per la lavorazione dello zucchero.
Realizzata in metallo verniciato e acciaio spazzolato.
Regolazione del corpo lampada in altezza ed in inclinazione.
Controllo della potenza su 2 livelli: 600- 1200W.
Piano di lavoro: 625 x 450 mm - completa di cablaggio elettrico.

Designed for sugar processing.
Made in varnished metal and brushed steel.
Height and tilt adjustment of the lamp body.
2-level power control: 600- 1200W.
Work surface: 625 x 450 mm - complete with electric cable.

Lampada - Lamp
LAMP01

Smontaggio rapido
Quick disassembly

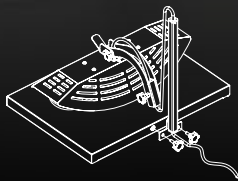

Inclinazione di 40°
del corpo lampada verso l'operatore

40° inclination of the lamp towards the operator

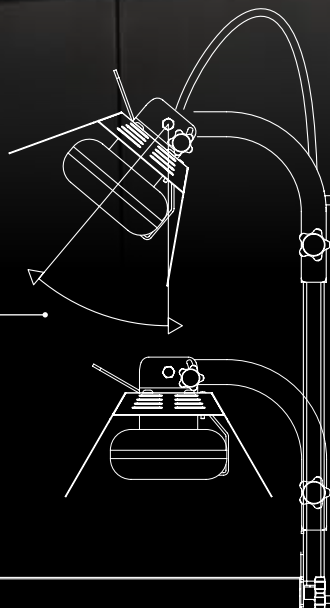

Cavo di alimentazione posizionato
all'interno per una maggiore sicurezza

The power cable runs inside the pole
for improved safety

Scorrimento verticale

Vertical scrolling

Maniglia per regolare l'inclinazione della lampada

Handle to adjust the lamp inclination

Base perfettamente planare

Perfectly planar base

Decoration

Cannelli multifunzionali per pasticceria, gastronomia e cucina.
Ideali per caramellare zucchero e meringhe, gratinare, scaldare e sciogliere.

Multifunctional kitchen torches for pastry, gastronomy and cooking.
Ideal for caramelising sugar and meringues, gratinating, heating and melting.



CANNELLO PRO

Dimensioni/dimensions 154x74x198 mm
Temperature 1300°C / 2400°F
Volume 140 ml butano/butane
Autonomia gas serbatoio pieno/burning
time full tank 60 min



CANNELLO BL

Dimensioni/dimensions 103x69x142 mm
Temperature 1300°C - 2400°F
Volume 64 ml butano/butane
Autonomia gas serbatoio pieno/burning
time full tank 60 min



CANNELLO BIG

Cartuccia usa e getta, corpo in plastica
Ugello 0,28 mm - Potenza 1.90 kW
Disposable cartridge torch, plastic body
Nozzle 0.28 mm - Power 1.90 kW

Fiamma regolabile, pulsante fiamma continua. Impugnatura antiscivolo, facilmente ricaricabile. Gas non incluso.
Adjustable flame, continuous flame button. Non-slip grip, easily rechargeable. Gas not included.



Porta phon
Blow dryer holder
50PP01



Paratia antivento acciaio inox
Stainless steel shelter
LAMPLEX
Dimensioni/dimensions 65x32 h 40 cm



Pompetta
Sugar pump
POMP



Supporto caramellometro
Caramellometer holder
MRTE
h13,7cm



Caramellometro
Caramellometer
MTE
da +80°C a +200°C
from +80°C to +200°C
h30cm

Guanti in lattice - Latex gloves

taglia - Size
7 - 7,5
GL 7

taglia - Size
8 - 8,5
GL 8

taglia - Size
9 - 9,5
GL 9



CAKE DESIGN

Italian[®]
Cake Art



SUGAR MATS

Tappeti in silicone ideali per vestire il tuo dolce con un decoro in zucchero di grande effetto.
Silicone mats ideal to dress up your cake with an impressive sugar decoration. Misura - Size: 30x40cm



40-WD001 Decorations: 388x88mm

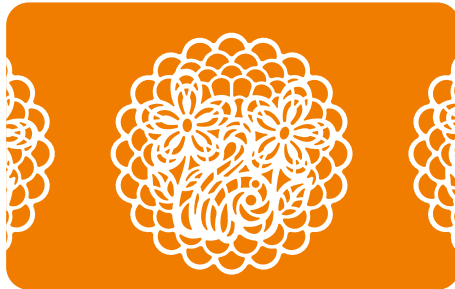

40-WD002 Decorations: Ø88mm

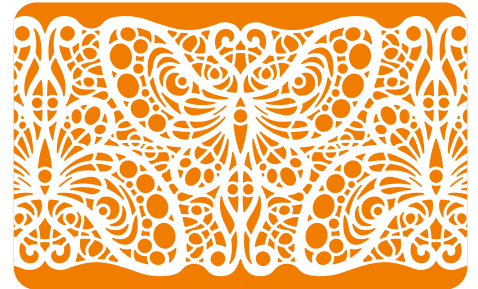

40-WD003 Decorations: 388x86mm

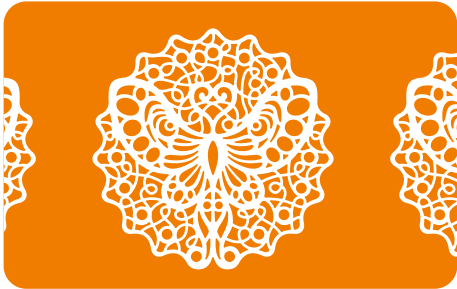

40-WD004 Decorations: Ø79mm

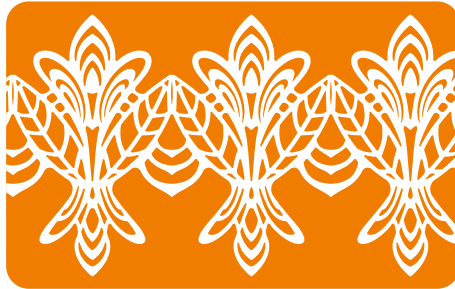

40-WD005 Decorations: 380x86mm



40-WD006 Decorations: 72x72mm

SUGAR DRESS

Preparato per la creazione di pizzi e decorazioni per torte, pasticcini e cupcake. **Sugar dress** è un sistema facile e veloce per ottenere un decoro raffinato e di grande effetto. È sufficiente aggiungere ai due preparati dell'acqua, mescolare bene il composto e spalmarlo con una spatola nell'apposito tappetino Martellato.

Prepared for the creation of lace and decorations for cakes, pastries and cupcakes. **Sugar dress** is an easy and quick system to obtain a refined and impressive decoration. Simply add water to the two preparations, mix the mixture well and spread it with a spatula in the special Martellato mat.



SUGAR DRESS

EFSD001
Bianca - White

Secchiello 500 gr - Bucket 500 gr
 GLUTEN FREE

EFSD002
Bianca - White

Secchiello 200 gr - Bucket 200 gr
 GLUTEN FREE

SUGAR PEARL

Preparato perlato per la creazione di pizzi e decorazioni alimentari. Pronte all'uso: mescolare bene e stendere il composto sugli stampi facendolo aderire perfettamente, aiutandosi con una spatola.

Pearl preparation for the creation of lace and food decorations. Ready to use: mix well and spread the mixture on the moulds making it adhere perfectly, using a spatula.



EFSP017
 SUGAR PEARL

Oro - Gold
 Secchiello 200 gr
 Bucket 200 gr
 AZO FREE



EFSP019
 SUGAR PEARL

Argento - Silver
 Secchiello 200 gr
 Bucket 200 gr
 AZO FREE

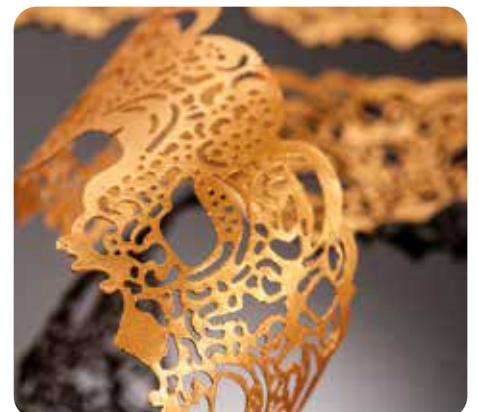

FIORI - FLOWERS



LILIUM



40-W049S

17x48mm - 24x70mm - 32x90mm - 39x110mm



40-W055

Controstampo - Formers

Ø 160 h60mm - Kit 4 pcs



SURFINIA

40-W193S

66x60 - 38x52 mm



40-W193C

Controstampo - Formers

Ø 75 h50mm - Kit 4 pcs



DAHLIA

40-W206S

Ø90mm - Ø65 mm



40-W206C

Controstampo - Formers

380x280mm - Kit 5 pcs



TULIP

40-W194S

27x46mm - 66x37mm



40-W194B

Supporto - Flower formers

Ø 100 h90mm - Kit 5 pcs



40-W194C

Controstampo - Formers

380x280mm - Kit 5 pcs

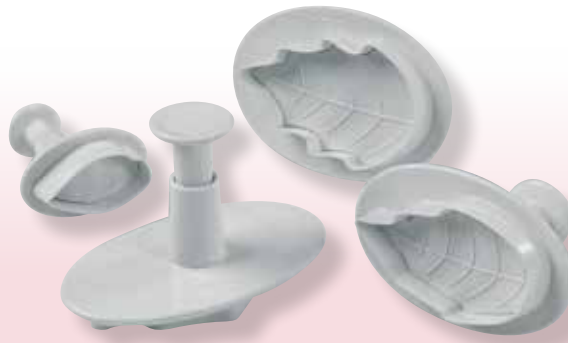

POINSETTIA

40-W188S

17x32 - 29x52 - 31x62 - 37x60 mm



IBISCUS

40-W051S

19x48mm - 27x70mm - 35x90mm - 44x110mm



40-W027

Controstampo - Formers
Ø 115 h55mm - Kit 4 pcs



ROSE

40-W028

32x29mm - 39x34mm - 47x40mm



ORCHID

40-W030

72x72mm - 96x66mm
57x31mm



40-W053

Controstampo - Formers
Ø 132 h55mm

VENATORI - VEINERS

Stampo **venatore** in silicone e **cutter** in plastica per venare petali e foglie.
Veiner silicon mould and plastic **cutter** to veiner petals and leaves.



40-WF001 81x55mm



40-WF002 55x46mm



40-WF003 110x97mm



40-WF007 160x69mm



40-WF008 89x31mm



40-WF009 66x39mm

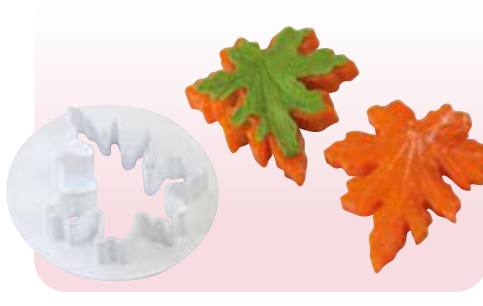

40-WF010 74x69mm



40-WF012 85x34mm

Pantografino - Pantograph

40-WA001V

Il kit include:

- 4 rotelline lisce - 4 coppie di rotelline ondulate
- 2 distanziatori da 15 mm - 2 distanziatori da 10 mm
- 4 distanziatori da 5 mm

The kit includes:

- 4 smooth wheels and 4 couples of fluted wheels
- 2 spacers 15 mm - 2 spacers 10 mm - 4 spacers 5 mm



CUTTER

LETTERE E NUMERI LETTERS AND NUMBERS

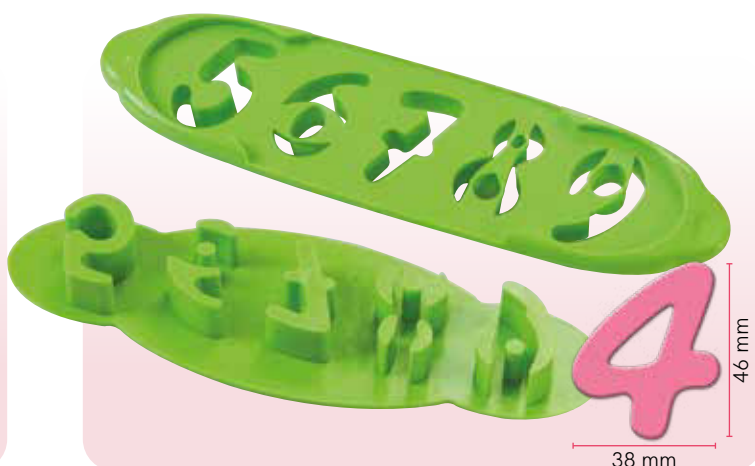
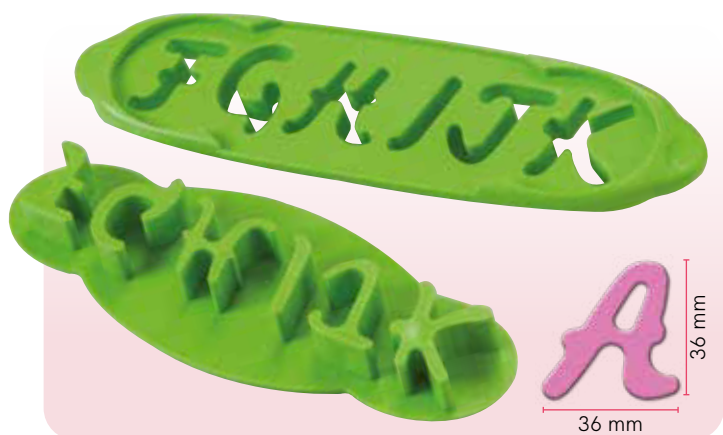

Cutter Lettere - GRANDI Letter Cutter - BIG

40-WA002

Il kit include: stampi lettere dalla A alla Z, set 5 pz
The kit includes: letters cutters from A to Z, set of 5 pcs



Cutter Letterine Small Letter Cutter

40-WA008

Il kit include: stampi lettere dalla A alla Z, set 5 pz
The kit includes: letters cutters from A to Z, set of 5 pcs



Cutter Numeri - GRANDI Numbers Cutter - BIG

40-WA003

Il kit include: stampi dallo 0 al 9 set 2 pz
The kit includes: cutters from 0 to 9, set of 2 pcs



Cutter Numerini Small Numbers Cutter

40-WA009

Il kit include: stampi dallo 0 al 9 set 2 pz
The kit includes: cutters from 0 to 9, set of 2 pcs



ATTREZZATURE SPECIALI - SPECIAL TOOLS



Mattarelli in teflon - Teflon Rolling pin

40-W021
Mattarello piccolo
Small rolling pin
Ø25mm - 230mm

40-W154
Mattarello medio
Medium rolling pin
Ø45mm - 350mm

40-W022
Mattarello lungo
Long rolling pin
Ø45mm - 500mm

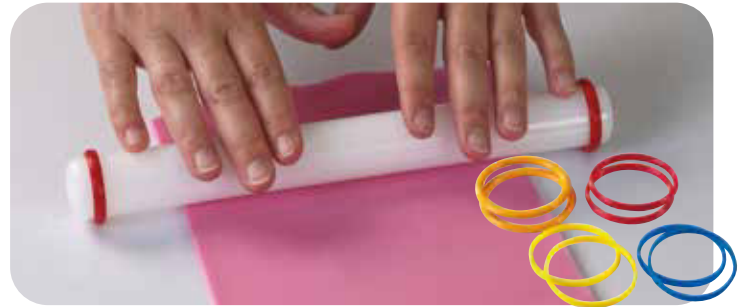

Set 8 Anelli - Set 8 Ring

40-W164A
Spessore - Thickness
4-5-6-10mm per/for:
40-W021 Ø25mm



**Paletta per lisciare
Smoother**

40-W004



**Kit 3 rotelline
3 wheels cutter kit**

40-W052

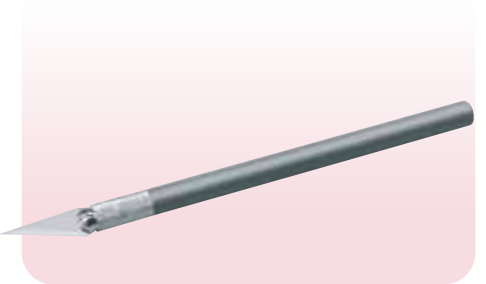

**Cutter bisturi
Scalpel cutter**

40-W031
Bisturi
Scalpel

40-W031R
Conf. 3 lame
Pack of 3 blades



**Cutter effetto imbottitura
Quilted effect cutter**

40-W198V
Misura-Size: 120x90mm

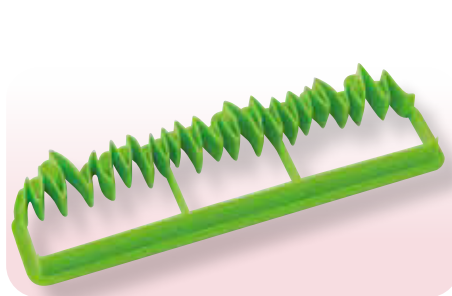

Cutter erba - Grass cutter

40-W199V
206x58mm



Sugar gun

40-WA007

Il kit include 20 dischetti intercambiabili
The kit includes 20 interchangeable discs



**Stencil rombi per effetto imbottitura
Rhomb stencil for quilted effect**

40-W108
Misura-Size: 200x330mm





Fiocchi neve - Snowflakes

40-W010S

Ø25mm - Ø40mm - Ø56mm



Tappeto per Fiori - Mat for flowers

40-W139

190x190mm



Agrifoglio - Holly

40-W043S

22x20mm - 30x28mm - 45x40mm



Cuoricini - Hearts

40-W013S

6x7mm - 8x10mm - 13x14mm

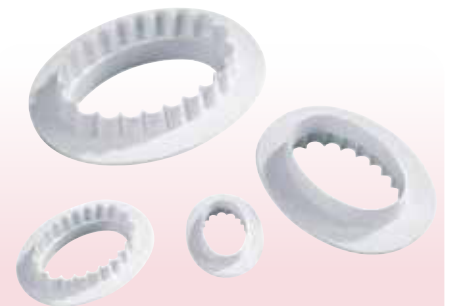

Ovali doppio taglio - Double cutter

40-W026

33x23 - 30x20 - 49x33 - 44x28
68x46 - 60x40 - 86x60 - 78x50mm

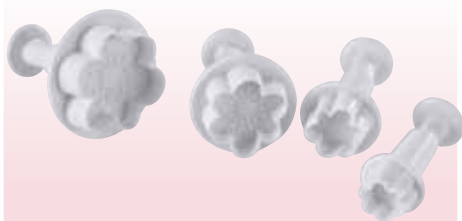

Fiore 6 petali - 6 petals flower

40-W161S

Ø14 - 18 - 25 - 33mm



Margherita - Daisy

40-W014S

Ø12 - 18 - 25 - 33mm



Foglie rosa - Rose leaves

40-W016S

27x19 - 32x21 - 40x27mm

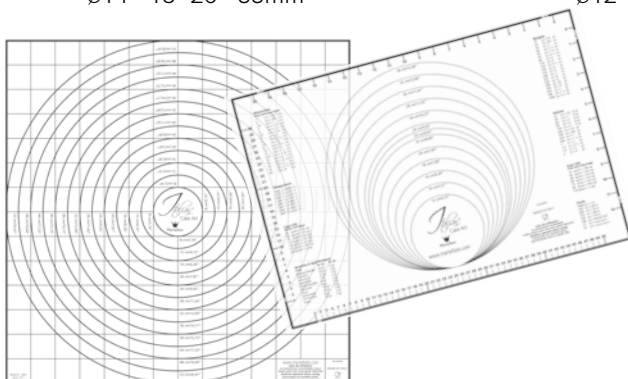

**Tappeto stendipasta in plastica
Plastic mat for dough rolling out**

in plastica con gommatura antiscivolo
made of plastic with non-slip rubber coating

40-W167
60x58cm

40-W141
60x40cm

AMPIA GAMMA DISPONIBILE NEL CATALOGO DEDICATO AL CAKE DESIGN
SEE ALL THE ITEMS ON OUR CAKE DESIGN CATALOGUE

AIRBRUSHES

Aeropenne professionali per colorare cioccolato e dolci, alimentate per gravità con forma ad imbuto per una facile pulizia e un flusso di colorante più efficiente. Presentano un regolatore di flusso ad azione singola o doppia e sono disponibili diverse misure di ugelli e capacità di serbatoi per adattarsi ad ogni esigenza di decorazione, rispondendo alle diverse necessità di precisione e velocità.

Professional airbrushes for colouring chocolate and sweets, gravity-fed funnel-shaped cup for a easy cleaning and a more efficient dye flow. They have a single or double action flow regulator and different nozzle sizes and tank capacities are available to adapt to any decoration need, responding to different precision and speed requirements.



DECOAIR 2

Cap. 7 CC
Ugello - Nozzle Ø 0,3mm
DUAL ACTION



DECOAIR 3

Cap. 2 CC
Ugello - Nozzle Ø 0,2mm
DUAL ACTION



DECOAIR 5

Cap. 20 CC - 40 CC
Ugello - Nozzle Ø 0,2mm
DUAL ACTION



DECOAIR 6

Cap. 2 CC - 5 CC - 13 CC
Ugello - Nozzle Ø 0,3mm
SINGLE ACTION

Dispositivo professionale portatile per la nebulizzazione del colorante alimentare. Funzionamento con pistone in teflon senza olio di lubrificazione. Pressione di esercizio costante garantita dal regolatore. Una soluzione perfetta per tutti i lavori di aerografia e nebulizzazione del colorante alimentare.

Portable professional device for the atomisation of food dye. Operation with teflon piston without lubrication oil. Constant working pressure guaranteed by the regulator. A perfect solution for all airbrushing and atomising of food dye.



DECOMP 9

6 BAR - Potenza - Power: 1/3 HP
Volume aria min./litres - Air output per min./litres: 30-35L/min
Voltaggio - Voltage: 220-240V / 50HZ
110-120V/60HZ 220V / 60HZ
Pressione Massima: Max.pressure: 6.5bar/95PSI
cavo di collegamento per aerografo incluso
connection cable for airbrush included



DECOMP 7

4 BAR Potenza - Power: 1/5 HP
Volume aria min./litres - Air output per min./litres: 23-25L/min
Voltaggio - Voltage: 220-240V / 50HZ
110-120V/60HZ 220V / 60HZ
Pressione Massima - Max.pressure: 6.5bar/95PSI

MINI AIRBRUSH

DECOCP02

Il kit completo per piccole decorazioni include:

- Penna aerografa a doppia azione, Ø 0,2mm;
- Mini Compressore da 1,5 BAR;
- Supporto per penna aerografa; • Borsa nera da viaggio.

Complete kit for small decorations includes:

- Airbrush double action, Ø 0.2mm;
- Mini compressor 1,5 BAR;
- Support for airbrush; • Black travel bag.



ACCESSORIES



DECOF01

Filtro aerografo.
Airbrush filter.



MD 2

Sostegno aerografo.
Airbrushes holder.



DECOH01

Sostegno aerografo.
Airbrushes holder.

STENCIL

Realizzati in resistente materiale plastico traslucido, gli stencil per aerografia permettono di produrre decorazioni su superfici verticali e curve.

Ideali per decorare torte da ricorrenza personalizzate.

Ampia gamma disponibile nel catalogo dedicato al cake design.

Made of resistant translucent plastic material, the airbrush stencils allow you to produce decorations on vertical and curved surfaces.

Ideal for decorating personalized cakes. Wide range available in the catalog dedicated to cake design.

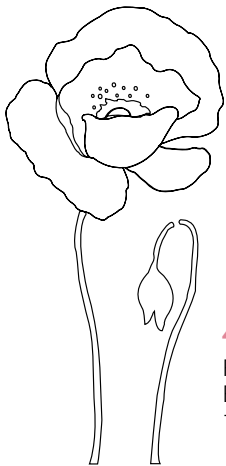

40-WM038

Papavero grande e bocciolo
Big poppy and bud stencil
130x65 mm



40-WM039

Papaveri e bocciolo
Big, small and bud poppy
110x62 mm - 60x30 mm



40-WM007

Farfalle - Butterflies
92x78mm - 50x43mm



40-WM027

Rosa aperta - Open rose
93x150mm



40-WM042

Loto - Lotus Flower
106x101mm



40-WM506

Loto - Lotus Flower
132x152mm
KIT 2 STENCIL



40-WM045

Savana
230x230mm

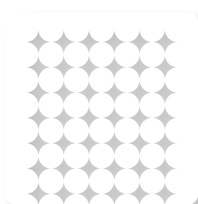

40-WR002

Pois
230x230mm

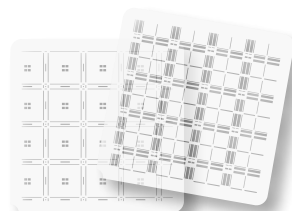

40-WR003

Tartan
230x230mm
KIT 2 STENCIL



40-WM046

Pied de poule
230x230mm

STENCIL

Decorative

Pratici e veloci stencil per decorare torte, vaschette gelato, piatti e qualsiasi altro dessert. In materiale plastico per alimenti.

Misure: Ø260mm. Spessore 0,8 mm

Practical and fast stencils to decorate cakes, ice cream, dishes and any other dessert.

Made of food safe plastic.

Sizes: Ø260mm. Thickness 0,8 mm





MINI STENCIL



cap. 280 g
SETACIOK
Ø65 h90mm



cap. 450 g
SETACIOK2
Ø73 h120mm

In materiale plastico per alimenti.
Misure: Ø95mm. Spessore 0,8 mm
Made of food safe plastic.
Sizes: Ø95mm. Thickness 0,8 mm

Ideali per monoporzioni
Ideal for single serving



KITMS1
Kit 10 pcs

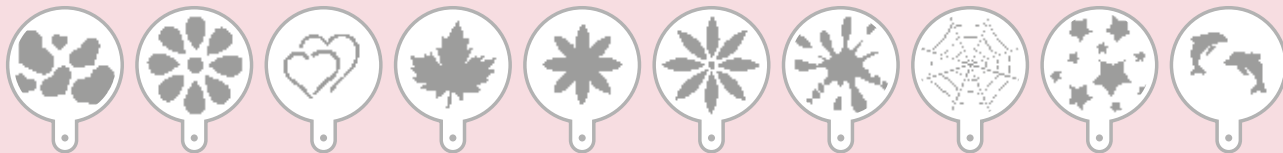

KITMS2
Kit 10 pcs



KITMS3
Kit 4 pcs



KITMS4
Kit 4 pcs



CREATIVE STENCIL

Stencil in plastica bianca.
White plastic stencil.
Misura - Size:
295x200mm



PMFORK
30x125 x h1,5mm - 12pcs



PMSPOON
30x130 x h1,5mm - 12pcs



PMKNIFE
20x130 x h1,5mm - 14pcs

Stencil in plastica trasparente. - Transparent plastic stencil.
Misura - Size: 310x510mm



SCSP01
130x30 x h2mm - 30pcs



SCSP03
75x35x h2mm - 40pcs



SCSP04
65x40 x h2mm - 32pcs

DECORATING TOOLS



Coltello - Knife
50WA006B
1 coltello / 1 knife



Kit Attrezzi decoro - Modelling tool set
50WA004B
12 strumenti doppia punta
1 coltello - 1 raschietto
12 dual-heads tools
1 knife - 1 scraper



Kit Attrezzi decoro - Modelling tool set
50WA005B
12 strumenti doppia punta
1 coltello - 1 raschietto
12 dual-heads tools
1 knife - 1 scraper



Coltello - Knife
40-WA006V
1 coltello / 1 knife



Kit Attrezzi decoro - Modelling tool set
40-WA004V
12 strumenti doppia punta
12 dual-heads tools



Kit Attrezzi decoro - Modelling tool set
40-WA005V
12 strumenti doppia punta
12 dual-heads tools

DECORATIVE STENCIL

Griglie in materiale plastico per creare decori con il cioccolato e con biscuit.
 Plastic grills for chocolate and biscuit decorations.
 Spessore - Thickness: 8 mm



Size cm	Cod.
30x20	GS01
60x40	GD 01



Size cm	Cod.
30x20	GS02
60x40	GD 02



Size cm	Cod.
30x20	GS03
60x40	GD 03



Size cm	Cod.
30x20	GS04
60x40	GD 04



Size cm	Cod.
60x40	GD 05



Size cm	Cod.
60x40	GD 06



Size cm	Cod.
60x40	GD 07

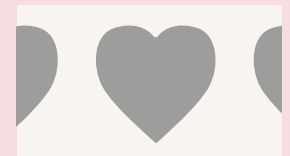

Size cm	Cod.
30x20	GS08
60x40	GD 08



Size cm	Cod.
60x40	GD 09



Size cm	Cod.
60x40	GD 10



Size cm	Cod.
30x20	GS11
60x40	GD 11



Size cm	Cod.
60x40	GD 12



Size cm	Cod.
60x40	GD 13

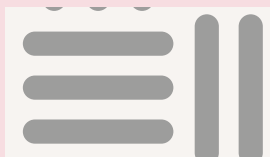

Size cm	Cod.
30x20	GS14
60x40	GD 14



Size cm	Cod.
60x40	GD 15



Size cm	Cod.
30x20	GS16
60x40	GD 16



Size cm	Cod.
30x20	GS17
60x40	GD 17



Size cm	Cod.
60x40	GD 18



Size cm	Cod.
60x40	GD 19



Size cm	Cod.
30x20	GS21
60x40	GD 21



Size cm	Cod.
30x20	GS22
60x40	GD 22

DECORATIVE COMBS

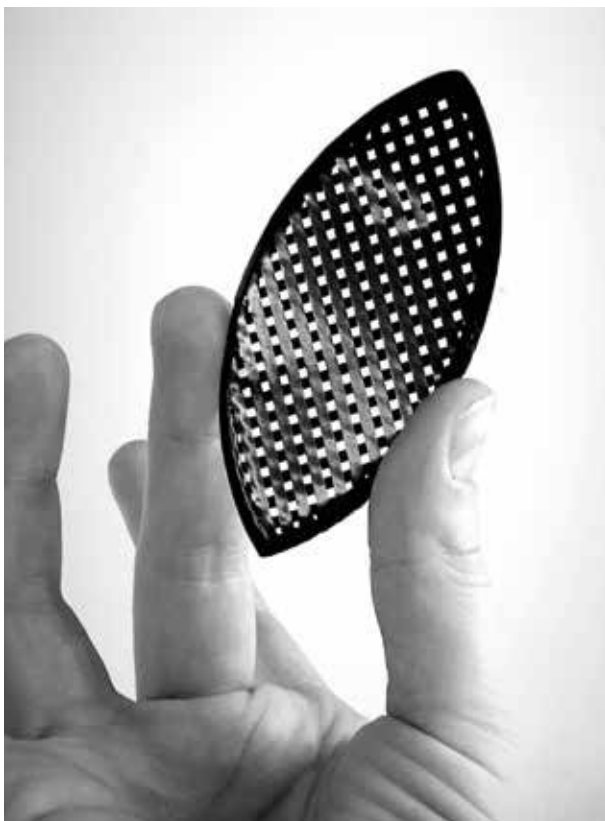
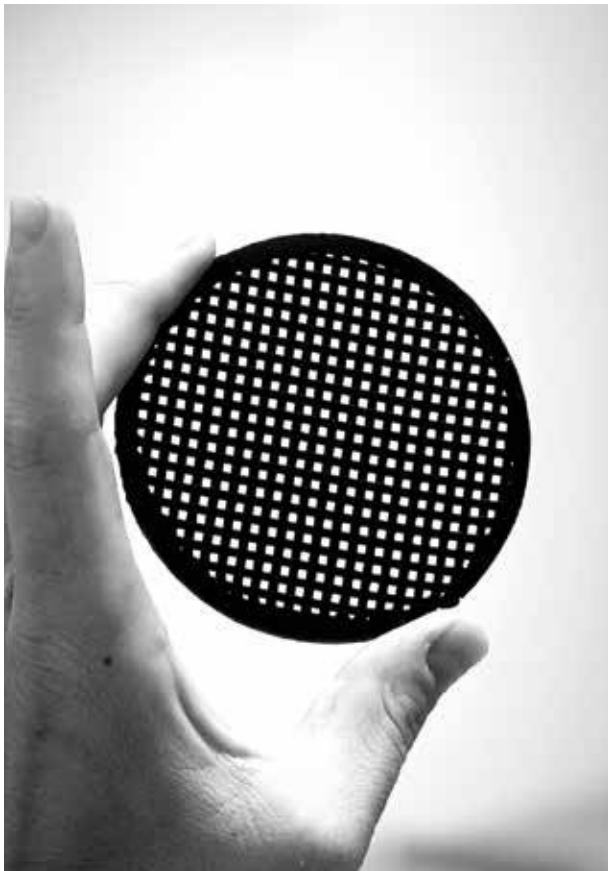

PD

PDM

PDS

Pettini in materiale plastico e gomma con doppio decoro, ideali per biscuit e cioccolato.

Combs in plastic and rubber with double decoration, ideal for biscuits and chocolate.

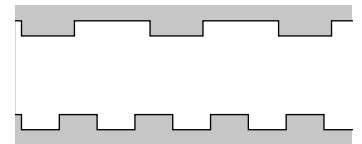
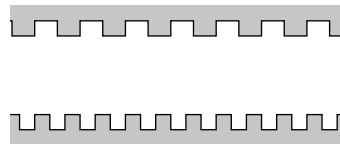

scale 1:1

cm	Cod.
70	PD1/2
34	PDM1/2
17	PDS1/2

cm	Cod.
70	PD3/4
34	PDM3/4
17	PDS3/4

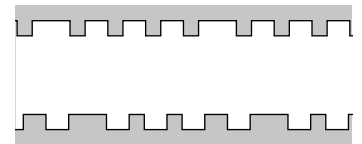
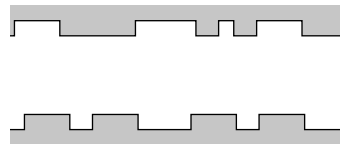

scale 1:1

cm	Cod.
70	PD5/6

cm	Cod.
70	PD7/8

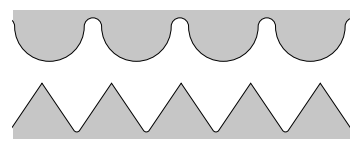
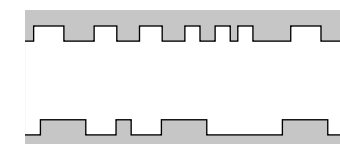

scale 1:1

cm	Cod.
34	PDM9/10

h cm	Cod.
70	PD13/14



Pettine per decorazioni a 3 colori
Three-colour decorating comb

PD11/12
70cm

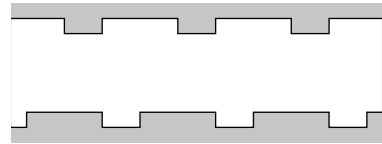

Pettini in materiale plastico per triplo decoro.
Plastic combs for triple decoration.



Tampone effetto legno
Wood motif decoration comb
materiale plastico - plastic

TFL10
10cm

TFL15
15cm



Pettini da decoro/Decorative combs
Acciaio inox - Stainless steel 18/8 Spessore - Thickness 0,50 mm

INOX 3
Triangular 100x103 mm
Square 100x100 mm
Rectangular 56x110 mm

DECORATIVE MATS

Tappeto in silicone per decori in rilievo. Silicone carpet for embossed decorations.
Size: 565x370 mm



RELIEF1
Misura - Size:
h 37mm



RELIEF2
Misura - Size:
Ø 4mm



RELIEF3
Misura - Size:
h 47mm



RELIEF4
Misura - Size:
h 30mm



RELIEF5
Misura - Size:
h 30mm



RELIEF6
Misura - Size:
h 30mm



RELIEF7
Misura - Size:
h 30mm



RELIEF8
Misura - Size:
h 30mm



RELIEF9
Misura - Size:
h 30mm



RELIEF10
Misura - Size:
h 30mm



RELIEF11
Misura - Size:
h 30mm



RELIEF12
Misura - Size:
h 30mm

CREATIVE COLORS

Velvet SPRAY

Spray a base di burro di cacao che dona un effetto vellutato.

L'articolo deve essere spruzzato su tutte le superfici fredde come gelato, semifreddi, mousse e cioccolato, perchè il burro di cacao cristallizzi creando l'effetto desiderato.

Spray cocoa butter with a velvety effect.

The article can be sprayed on all cold surfaces such as ice cream, semifreddo, mousse and chocolate.





							
<i>COLORE</i> <i>COLOR</i>	BIANCO WHITE	GIALLO YELLOW	ROSA PINK	LILLA LILAC	VERDE GREEN	AZZURRO SKY-BLUE	FUCSIA FUCHSIA
<i>ML</i>	400 ml	400 ml	400 ml	400 ml	400 ml	400 ml	400 ml
<i>COD</i>	LCV000	LCV204	LCV207	LCV210	LCV209	LCV003	LCV107

							
<i>COLORE</i> <i>COLOR</i>	ROSSO RED	ARANCIO ORANGE	CIOC. LATTE MILK CHOCO	CIOC. FOND. DARK CHOCO	NERO BLACK	CIOC. BIANCO WHITE CHOC.	AMARENA BLACKCHERRY
<i>ML</i>	400 ml	400 ml	400 ml	400 ml	400 ml	400 ml	400 ml
<i>COD</i>	LCV208	LCV001	LCV005N	LCV015N	LCV206	LCV224	LCV213

COLOR DUST

LIPOSOLUBLE

Colorante in polvere liposolubile adatto alla colorazione in massa di prodotti a base grassa quali cioccolato, crema al burro, pasta di mandorle, pasta da zucchero, semifreddi. Può essere utilizzato in superficie con un pennello tal quale o diluito con la nostra gommalacca liquida per ottenere un prodotto per la decorazione a pennello.

Fat-soluble powder colour appropriate for in mass colouring of fat based products like chocolate, butter cream, almond paste, sugar paste, semifreddo. You could use it as such on product surface using a brush or you can dilute it using our liquid shiny obtaining a product for decoration by brush.



COLORE COLOR	BIANCO WHITE	BLU BLUE	GIALLO YELLOW	MARRONE BROWN	NERO BLACK	ROSA PINK
GR	25 GR	25 GR	25 GR	20 GR	25 GR	25 GR
COD	LCP300	LCP302	LCP304	LCP305	LCP306	LCP307N
GR	5 GR	5 GR	5 GR	5 GR	5 GR	5 GR
COD	40-WC300	40-WC302	40-WC304	40-WC305	40-WC306	40-WC307



COLORE COLOR	ROSSO RED	ROSSO SHOCK RED SHOCK	VERDE GREEN	ARANCIO ORANGE	TURCHESE TURQUOISE
GR	25 GR	25 GR	25 GR	25 GR	25 GR
COD	LCP308	LCP308N	LCP309N	LCP311	LCP326
GR	5 GR	5 GR	5 GR	5 GR	5 GR
COD	40-WC308	40-WC308N	40-WC309	40-WC311	40-WC326

Creative
Colours



PEARL



COLORE COLOR	AZZURRO SKY-BLUE	ROSSO RED	VERDE GREEN	VIOLA VIOLET	BRONZO BRONZE	ORO GOLD
GR	25 GR	25 GR	25 GR	25 GR	25 GR	25 GR
COD	LCP003	LCP008	LCP009	LCP010	LCP015	LCP017N
GR					5 GR	5 GR
COD					40-WC015	40-WC017



COLORE COLOR	ORO BRIGHT GOLD	RUBINO RUBY	ARGENTO SILVER	ARGENTO BRIGHT SILVER	RAME COPPER	FUCSIA FUCHSIA
GR	25 GR	25 GR	25 GR	25 GR	25 GR	25 GR
COD	LCP117	LCP018	LCP019N	LCP119	LCP020	LCP021
GR	5 GR			5 GR	5 GR	
COD	40-WC117			40-WC119	40-WC020	

COLOR DUST

WATER-SOLUBLE

Colorante in polvere idrosolubile ideale per la colorazione in massa di prodotti a base acqua quali isomalto, zucchero, panna, meringhe, macarons ed altre preparazioni.

Water-soluble powder ideal to mass colouring water-based products like isomalt, sugar, cream, meringue, macarons and other.



<i>COLORE COLOR</i>	BLU BLUE	GIALLO YELLOW	NERO BLACK	ROSSO RED	VERDE GREEN	ARANCIO ORANGE	ROSSO FRAGOLA STRAWBERRY	TURCHESE TURQUOISE
<i>GR</i>	25 GR	25 GR	25 GR	25 GR	25 GR	25 GR	25 GR	25 GR
<i>COD</i>	LCP202	LCP204	LCP206	LCP208	LCP209N	LCP211	LCP218	LCP226











gel **COLOR**

Colorante in gel idrosolubile molto concentrato nato per la colorazione in massa di tutti i prodotti a base acqua o emulsioni come pasta di zucchero, panna, crema al burro, glassa, impasti vari quali biscotti meringhe e torte.

Very concentrated water-soluble gel colour created for the mass coloring of all water-based products or emulsions such as sugar paste, cream, butter cream, icing, various doughs such as meringue biscuits and cakes.



						
<i>COLORE</i> <i>COLOR</i>	BIANCO WHITE	ROSSO RED	VERDE GREEN	VIOLA VIOLET	VERDE LIME LIME GREEN	TURCHESE TURQUOISE
<i>GR</i>	30 GR	30 GR	30 GR	30 GR	30 GR	30 GR
<i>COD</i>	LCG000	LCG008	LCG009	LCG010	LCG016	LCG026







						
<i>COLORE</i> <i>COLOR</i>	ARANCIO ORANGE	BLU BLUE	GIALLO YELLOW	MARRONE BROWN	NERO BLACK	ROSA PINK
<i>GR</i>	30 GR	30 GR	30 GR	30 GR	30 GR	30 GR
<i>COD</i>	LCG001	LCG002	LCG004	LCG005	LCG006	LCG007

DRIP Top

Prodotto di facile utilizzo per decorare tramite la tecnica del dripping torte, semifreddi, gelati e molto altro.

Product easy to use to decorate cakes using the dripping technique, frozen desserts, ice cream and much more.



						
COLORE COLOR	BLU BLUE	ROSA PINK	ROSSO CILIEGIA CHERRY RED	CIOC. BIANCO WHITE CHOCOLATE	CIOCCOLATO CHOCOLATE	PEARL ORO PEARL GOLD
GR	180 gr	180 gr	180 gr	180 gr	180 gr	180 gr
COD	40LCD003	40LCD007	40LCD008	40LCD024	40LCD005	40LCD017

Metal DUST

Colorante in fine polvere con effetto perlato ideale per decorare prodotti finiti, presentato con speciale packaging spray non pressurizzato.

Soft powder colour with a pearly effect in a special non-pressurized spray packaging.



				
COLORE COLOR	ORO GOLD	ARGENTO SILVER	ROSSO RED	ORO ROSA GOLD ROSE
GR	10 GR	10 GR	6 GR	10 GR
COD	LCP517	LCP519	LCP508	LCP523



EASY COLOR

HYDROALCOHOLIC

Colorante liquido pronto all'uso pensato ad assicurare una nebulizzazione perfetta ed omogenea sulle superfici. Adatto a realizzare sfumature di colore su prodotti finiti come torte, pasta di zucchero e cioccolato tramite l'utilizzo di aerografi.

Hydroalcoholic colour designed to ensure perfect and homogeneous nebulization on surfaces. Suitable for creating shades of colour on finished products such as cakes, sugar paste and chocolate through the use of airbrushes.



			
<i>COLORE</i> <i>COLOR</i>	BIANCO OPACO MATT WHITE	ROSA OPACO MATT PINK	GIALLO OPACO MATT YELLOW
<i>ML</i>	75 ML	75 ML	75 ML
<i>COD</i>	LCA300	LCA307	LCA304

			
<i>COLORE</i> <i>COLOR</i>	ARG. PERLATO PEARL SILVER	ROSSO PERLATO PEARL RED	ORO PERLATO PEARL GOLD
<i>ML</i>	100 ML	100 ML	100 ML
<i>COD</i>	LCA419	LCA408	LCA417















EASY COLOR

WATER-SOLUBLE

Colorante liquido pronto all'uso, pensato per assicurare una nebulizzazione perfetta ed omogenea sulla superficie di torte e dolci attraverso l'utilizzo di aerografi. Grazie alla sua formula idrosolubile, è ideale anche per la colorazione in massa di pan di spagna, panna, crema, gelatina, pasta di mandorle, marzapane e bevande in genere.

Ready-to-use liquid colour, designed to ensure a perfect and homogeneous nebulization on the surface of cakes and sweets through the use of airbrushes. Thanks to its water-soluble formula, it is also ideal for the mass coloring of sponge cake cream, cream, jelly, almond paste, marzipan and drinks in general.

								
COLORE COLOR	BIANCO WHITE	NERO BLACK	GIALLO CHIARO LIGHT YELLOW	GIALLO SCURO DARK YELLOW	MARRONE BROWN	VIOLA VIOLET	ROSA PINK	ROSSO RED
ML	190 ML	190 ML	190 ML	190 ML	190 ML	190 ML	190 ML	190 ML
COD	LCA000	LCA006	LCA011	LCA004	LCA005	LCA010	LCA007N	LCA008N

							
COLORE COLOR	ARANCIO ORANGE	BLU BLUE	AZZURRO SKY-BLUE	VERDE GREEN	VERDE CHIARO LIGHT GREEN	ARG. PERLATO PEARL SILVER	ORO PERLATO PEARL GOLD
ML	190 ML	190 ML	190 ML	190 ML	190 ML	190 ML	190 ML
COD	LCA001	LCA002	LCA003	LCA009	LCA012	LCA219	LCA217



CHOCOLOR

Food Coloring Cocoa Butter

Burro di cacao colorato, ideale per la colorazione e decorazione di cioccolato e masse grasse.

Coloured cocoa butter, perfect to colour and decorate chocolate and fat masses.







Il maestro cioccolatiere Massimo Carnio, campione italiano al World Chocolate Masters di Cacao Barry e vincitore della Coppa del Mondo della Gelateria 2020 ha collaborato con Martellato per ottimizzare la gamma di burri di cacao colorati, creando un prodotto unico nelle prestazioni.

"Da molti anni, lavorando con il cioccolato, avvertivo la necessità di un prodotto che mi garantisse un risultato sempre perfetto. Con Martellato abbiamo lavorato sulla composizione e sulle tonalità per ottenere il prodotto ideale".

Master chocolatier Massimo Carnio, Italian winner of the Cacao Barry World Chocolate Masters and winners of Gelato World Cup 2020 has worked with Martellato to optimize the range of colored cocoa butters, creating a unique product in performance.

"For many years, working with chocolate, I felt the need for a product that would always guarantee me a perfect result. With Martellato we worked on the composition and tonalities to obtain the ideal product".



					
COLORE COLOR	ARANCIO ORANGE	ROSA PINK	TURCHESE TURQUOISE	MARRONE BROWN	LIME YELLOW
GR	200 GR	200 GR	200 GR	200 GR	200 GR
COD	LCB201	LCB207	LCB226	LCB205	LCB204N



								
COLORE COLOR	VIOLA VIOLET	BLU BLUE	NERO BLACK	ROSSO RED	VERDE GREEN	BIANCO WHITE	GIALLO YELLOW	ORO GOLD
GR	200 GR	200 GR	200 GR	200 GR	200 GR	200 GR		
COD	LCB210	LCB202	LCB206	LCB208	LCB209	LCB200		
GR	30 GR	30 GR	30 GR	30 GR	30 GR	30 GR	30 GR	30 GR
COD	40-WCB210	40-WCB202	40-WCB206	40-WCB208	40-WCB209	40-WCB200	40-WCB204	40-WCB217



color SMART *Matt*

Spray colorati idroalcolici ideali per decorare torte a base di panna, piccole decorazioni di cioccolato, prodotti di pasticceria come biscotti, wafer, cialde e dolci a base di pasta di zucchero.

Colored hydroalcoholic sprays ideal for decorating cream-based cakes, small chocolate decorations, pastry products such as biscuits, wafers, waffles and sugar paste covered cakes.



COLORE COLOR	ARANCIO ORANGE	AZZURRO SKY-BLUE	GIALLO YELLOW	MARRONE BROWN	ROSA PINK	ROSSO RED	VERDE GREEN
ML	100 ML	100 ML	100 ML	100 ML	100 ML	100 ML	100 ML
COD	LCS001	LCS003	LCS004	LCS005	LCS007	LCS008	LCS009

color SMART *Pearl*

Spray colorati idroalcolici ideali per decorare torte a base di panna, piccole decorazioni di cioccolato, prodotti di pasticceria come biscotti, wafer, cialde e dolci a base di pasta di zucchero.

Colored hydroalcoholic sprays ideal for decorating cream-based cakes, small chocolate decorations, pastry products such as biscuits, wafers, waffles and sugar paste covered cakes.

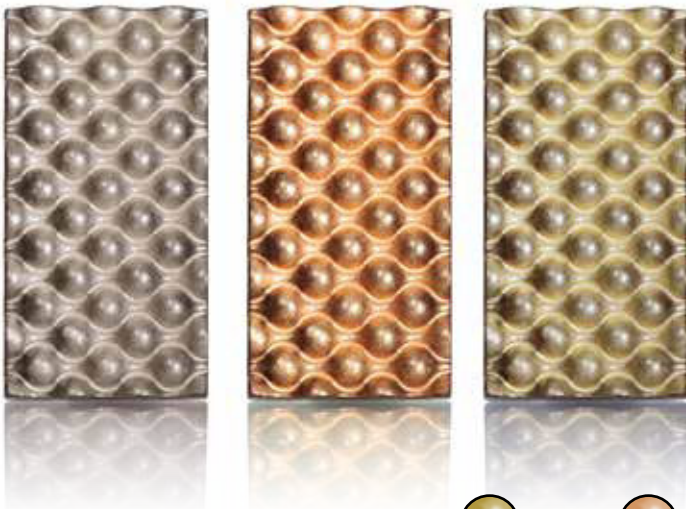

COLORE COLOR	ORO GOLD	BRONZO BRONZE	RAME COPPER	RUBINO RUBY	ARGENTO SILVER
ML	100 ML	100 ML	100 ML	100 ML	100 ML
COD	LCS217N	LCS215	LCS220	LCS218N	LCS219N

color SMART *Glitter*

Spray idroalcolico ad effetto glitterato ideale per decorare e colorare torte a base di panna e cioccolato oppure prodotti di pasticceria come biscotti wafer, cialde e tutti i dolci a base di pasta da zucchero.

Glittering effect hydroalcoholic spray ideal for decorating and coloring cream and chocolate cakes or pastry products such as wafer biscuits, waffles and all sugar paste covered cakes.



COLORE COLOR	GLITTER GOLD	GLITTER SILVER
ML	100 ML	100 ML
COD	40LCS417	40LCS419

color SMART *Metal*

Spray idroalcolici ad effetto metallico ideali per decorare e colorare superfici scure, come decorazioni di cioccolato fondente. Dona un effetto metallizzato. Se usato su superfici chiare, come cioccolato bianco, dona un effetto madreperla.

Metallic effect hydroalcoholic sprays ideal for decorating and coloring dark surfaces, such as dark chocolate decorations. Gives a metallic effect. If used on light surfaces, such as white chocolate, it gives a mother-of-pearl effect.







COLORE COLOR	BLU METAL METAL BLUE	ROSSO METAL METAL RED	ORO METAL METAL GOLD
ML	250 ML	250 ML	250 ML
COD	40LCS102	40LCS108	40LCS117

Natural COLOR *idro*

Colorante alimentare naturale in polvere idrosolubile ideale per la decorazione e colorazione di meringhe, macaron, glasse e molto altro.

Water-soluble natural food coloring powder ideal for the decoration and coloring of meringues, macaron, glaze and much more.



					
COLORE COLOR	NERO BLACK	GIALLO YELLOW	ROSSO RED	BLU BLUE	VERDE GREEN
GR	25 gr	25 gr	25 gr	25 gr	25 gr
COD	40LCPN206	40LCPN204	40LCPN208	40LCPN202	40LCPN209







Per garantire qualità e durata degli ingredienti utilizzati, i coloranti saranno prodotti su richiesta.
To guarantee the quality and the shelflife of the ingredients used, these colourants will be produced upon request.

Natural COLOR *lipo*

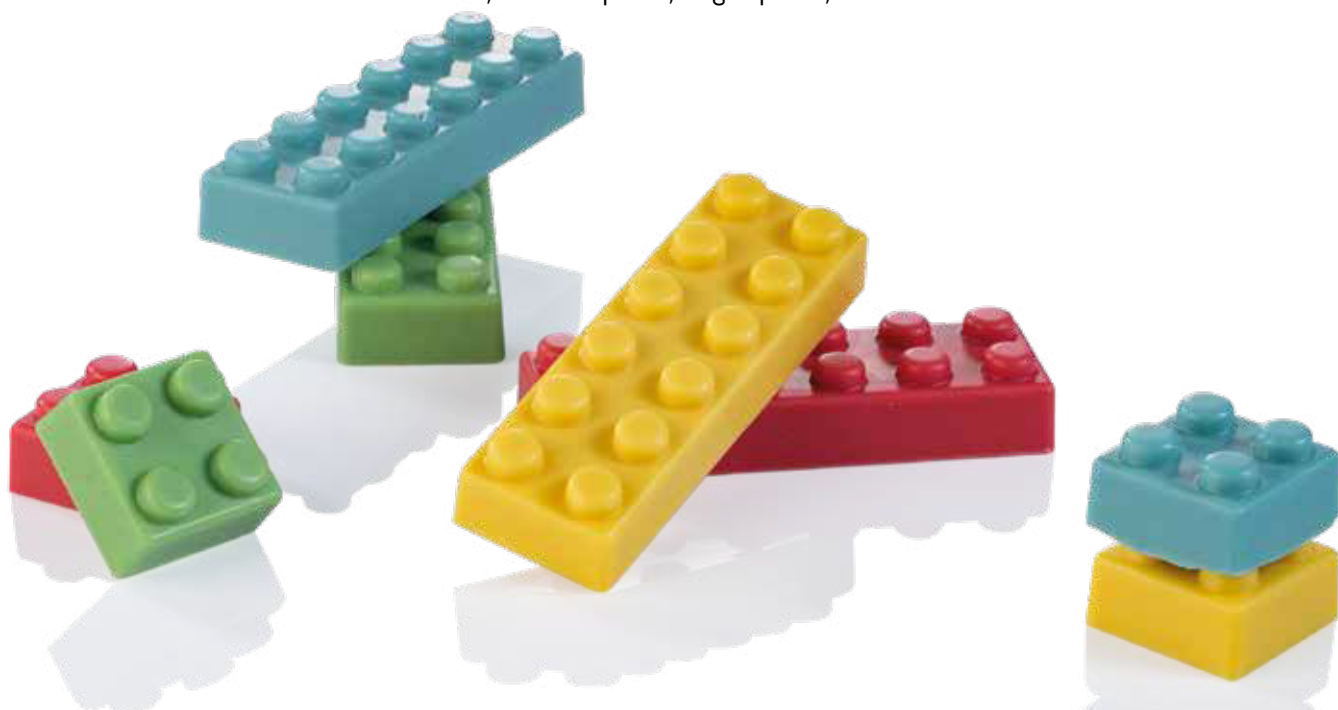
Colorante alimentare naturale in polvere liposolubile adatto alla colorazione in massa di prodotti a base grassa quali cioccolato, crema al burro, pasta di mandorle, pasta da zucchero, semifreddi.

Edible natural dye. Liposoluble powder colour suitable for the mass coloring of fat-based products such as chocolate, butter cream, almond paste, sugar paste, semifreddo.



				
COLORE COLOR	BLU BLUE	VERDE GREEN	ROSSO RED	GIALLO YELLOW
GR	25 gr	25 gr	25 gr	25 gr
COD	40LCPN302	40LCPN309	40LCPN308	40LCPN304



Per garantire qualità e durata degli ingredienti utilizzati, i coloranti saranno prodotti su richiesta.
To guarantee the quality and the shelflife of the ingredients used, these colourants will be produced upon request.

Butter SPRAY



Lucidante alimentare neutro a base di burro di cacao ideale per proteggere e lucidare marzapane e pasta di mandorle.

Neutral food polish made of cocoa butter ideal for protecting and polishing marzipan and almond paste.

LCV100
Butter spray
400 ml

Baking SPRAY



Staccante alimentare ideale per velocizzare la rimozione del prodotto da teglie in acciaio e alluminio, stampi, termoformati o altro.
Inodore e insapore.

Ideal food release agent to speed up the removal of the product from steel and aluminium trays, moulds, thermoformed or other.
Odorless and tasteless.

COATING
Coating spray
400 ml

Shiny SPRAY



Gommalacca spray ideale per lucidare e proteggere superfici a base di zucchero e cioccolato.

Shellac spray ideal for polishing and protecting sugar and chocolate surfaces.

LCS201
Gommalacca spray
Shellac 300 ml

Cooling SPRAY



Refrigerante spray per raffreddamento istantaneo di prodotti a base di zucchero o cioccolato durante la lavorazione artistica.

Spray cooler for instant chilling of sugar or chocolate products during the artistic processing.

EUROCHOCK
Cooler spray
400 ml



JELLIES

Gelatina alimentare ideale per guarnire torte e prodotti di pasticceria in genere, può essere colorata con i gel color e con le polveri idrosolubili.

Food-grade gelatine ideal for garnishing cakes and pastry products in general, it can be coloured with colourant gels and water-soluble powders.



LCJ000
1 kg - Transparent

LCJ100
1 kg - Glitter

CMC

Additivo alimentare utilizzato come addensante. Aggiungendolo alla pasta zucchero si ottiene una pasta più resistente e più facile da modellare.

Food additive used as thickener. By adding it to the sugar paste it produces a more resistant and easier to shape paste.



40-W042
40 gr

GLUE

Colla alimentare per la creazione di soggetti in pasta di zucchero e cialda.

Food glue for the creation of sugar paste and wafer subjects.



40-W166
25 gr

BANQUETING

ELEGANT

Catering Solution

Design e qualità contraddistinguono gli eleganti ed infrangibili articoli ideali per ogni professionista del settore HORECA, della pasticceria e della gelateria. **Realizzati da Martellato** con materiale di alta qualità, che conferisce, oltre alla resistenza, anche lucidità e trasparenza. Prodotti in Italia, gli articoli Martellato rappresentano la più valida alternativa al vetro.

Design and quality characterise the elegant and unbreakable disposable items ideal for every professional in the HORECA, pastry and ice-cream sector. **Made by Martellato** with high quality material, which gives, in addition to resistance, also lucidity and transparency. Produced in Italy, the Martellato items provide the most valid alternative to glass.



I RIUTILIZZABILI

Rispettano l'ambiente due volte. Grazie al materiale di alta qualità con il quale sono prodotti, i piattini per individual dessert - così come tutti i gli articoli della linea Elegant Catering Solution - **possono essere riutilizzati più volte.** E una volta gettati, sono riciclabili al 100%.

THE REUSABLE

They respect the environment twice. Thanks to the high quality material with which they are made, the plates for individual desserts - like all the items of the Elegant Catering Solution line - **can be reused several times.** And once disposed, they are 100% recyclable.



PENTA

CAP. **120** ML
68x65 h 56 mm
PACK 100 **PMOPE001**

WAFLE

CAP. **70** ML
64x62 h 59mm
PACK 100 **PMOCO013**

SOFT ICE

CAP. **105** ML
Ø70 h 59mm
PACK 100 **PMOCO014**



GREEK

CAP. **120** ML
73x71 h 61mm
PACK 100 **PMOCO009**

CAP. **190** ML
92x90 h 75mm
PACK 100 **PMOCO010**

CAP. **50** ML
50x48 h 57mm
PACK 100 **PMOCO008**



CUBÒ

CAP. **58** ML
50x50 h55 mm
PACK 100 **PMOCU004**



Coperchi - Lids
PACK 100 **PMOCU002/C**



SQUARE

CAP. **60** ML
40x40 h55 mm
PACK 100 **PMOCU001**

CAP. **120** ML
50x50 h70 mm
PACK 100 **PMOCU002**

CAP. **175** ML
57x57 h73 mm
PACK 100 **PMOCU003**



Coperchi - Lids
PACK 100 **PMOCU002/C**



Coperchi - Lids
PACK 100 **PMOCU003/C**



WAVE

CAP. **200** ML
100x70 h 83mm
PACK 100 **PMOCE003**

CAP. **120** ML
85x60 h70 mm
PACK 100 **PMOCE002**

CAP. **50** ML
64x46 h53 mm
PACK 100 **PMOCE001**



VELA

CAP. **200** ML
90x83 h 74mm
PACK 100 **PMOCO015**

CAP. **140** ML
73x81 h 67mm
PACK 100 **PMOCO012**

CAP. **85** ML
63x69 h 57mm
PACK 100 **PMOCO011**



CYLINDER

CAP. **190** ML
 Ø65 h85 mm
 PACK 100 **PMOCO007**

BUBBLE

CAP. **215** ML
 Ø90 h75 mm
 PACK 100 **PMOCO004**

CONE

CAP. **165** ML
 Ø90 h75 mm
 PACK 100 **PMOCO005**

DROP

CAP. **190** ML
 Ø75 h80 mm
 PACK 100 **PMOCO006**



JAPAN

CAP. **87** ML
 Ø50 h54 mm
 PACK 100 **PMOJA002**

CAP. **47** ML
 Ø42 h43 mm
 PACK 100 **PMOJA001**



HEART

CAP. **100** ML
73x64 h52 mm
PACK 100 **PMOLO001**



Coperchi - Lids
PACK 100 **PMOLO001/C**



CLASSIC

CAP. **65** ML
Ø42 h65 mm
PACK 100 **PMOTO001**

CAP. **90** ML
Ø50 h65 mm
PACK 100 **PMOTO002**

CAP. **120** ML
Ø55 h70 mm
PACK 100 **PMOTO003**

CAP. **170** ML
Ø60 h90 mm
PACK 100 **PMOTO004**



TUBE

CAP. **80** ML
Ø40 h85 mm
PACK 100 **PMO08.00**



TRIANGLE

CAP. **175** ML
81x83 h65 mm
PACK 100 **PMO07.00**



Coperchi - Lids
PACK 100 **PMO07/C**



CUP

CAP. **90** ML
Ø65 h55 mm
PACK 100 **PMOCO001**

CAP. **135** ML
Ø70 h67 mm
PACK 100 **PMOCO002**

CAP. **150** ML
Ø75 h73 mm
PACK 100 **PMOCO003**



BUCKET

CAP. **210** ML
Ø78 h 57mm
PACK 100 **PMOTO005**

Coperchi - Lids
PACK 100 **PMOTO005/C**



ECLAIR

CAP. **120** ML
137x37 h41 mm
PACK 100 **PMOCL001**

Coperchi - Lids
PACK 100 **PMOCL001C**





BOWL



CAP. **460** ML
100x118 h70 mm

- PACK 50 **ZENBO00**
- PACK 50 **ZENBO01**
- PACK 50 **ZENBO02**

PLATE - LID



Piatto - Coperchio
100x118 h6 mm

- PACK 50 **ZENBO00C**

PLATE - TRAY



Piatto - Vassoio
110x245 h18 mm

- PACK 50 **ZENTR00**
- PACK 50 **ZENTR01**
- PACK 50 **ZENTR02**

SMALL PLATE



TONDO

85x96 h20 mm



-  PACK 100 [PL00100](#)
-  PACK 100 [PL00101](#)
-  PACK 100 [PL00102](#)

QUADRO

80x97 h20 mm



-  PACK 100 [PL00200](#)
-  PACK 100 [PL00201](#)
-  PACK 100 [PL00202](#)

RETTANGOLO

60x140 h20 mm



-  PACK 100 [PL00300](#)
-  PACK 100 [PL00301](#)
-  PACK 100 [PL00302](#)



MINI BOWL

CAP. **50** ML
75x75 h30 mm

- PACK 100 **PMO11.00**
- PACK 100 **PMO11.01**
- PACK 100 **PMO11.02**



TRIANGLE

CAP. **20** ML
85x85 h15 mm

- PACK 100 **PMO09.00**
- PACK 100 **PMO09.01**
- PACK 100 **PMO09.02**



BLOW

CAP. **30** ML
85x85 h30 mm

- PACK 100 **PMO10.00**
- PACK 100 **PMO10.01**
- PACK 100 **PMO10.02**



WING

CAP. **11** ML
105x50 h30 mm

- PACK 100 **PMO12.00**
- PACK 100 **PMO12.01**
- PACK 100 **PMO12.02**



SINGLE

CAP. **15** ML
65x65 h15 mm

 PACK 100 **PMO13.00**

 PACK 100 **PMO13.01**



DOUBLE

CAP. **20** ML
110x65 h20 mm

 PACK 100 **PMO14.00**



CAP. **120** ML
Ø72x h51 mm

 PACK 100 **PMOVA002.00**



CAP. **120** ML
Ø75,5x h35 mm

 PACK 100 **PMOVA003.00**



CAP. **120** ML
Ø67,5x h58 mm

 PACK 100 **PMOVA001.00**



CATERING DISPLAYS

Eleganti espositori in plexiglass dal **design ricercato e moderno, prodotti in Italia**. Sono ideali per allestire raffinati buffet per **cerimonie** o **incontri d'affari**. Resistenti e facili da montare e trasportare, sono completamente atossici.

Elegant plexiglass displays with **modern design, produced in Italy**. They are ideal for setting up refined buffets for **ceremonies** or **business meetings**. Resistant and easy to assemble and transport, they are completely non-toxic.

MADE IN ITALY

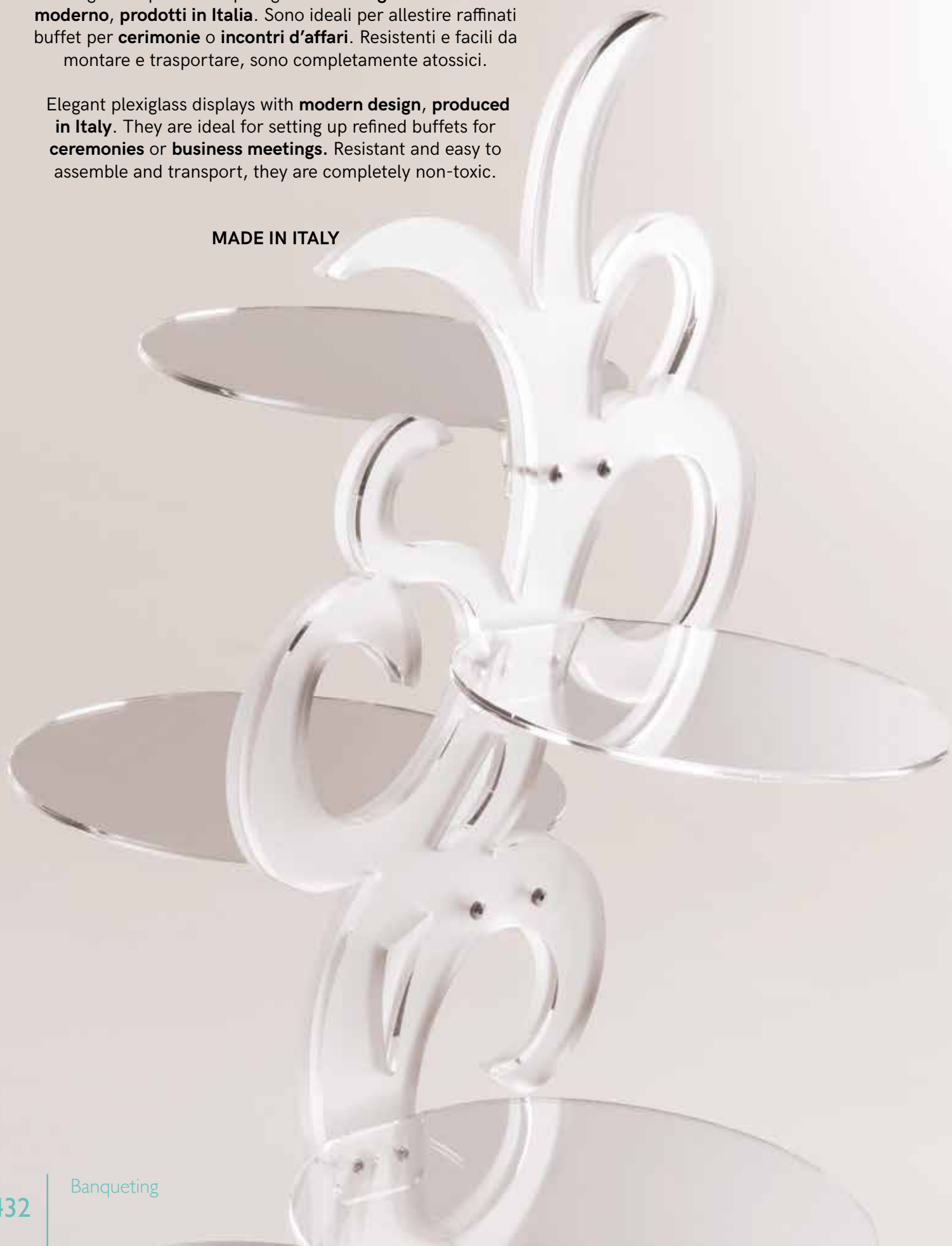



COD33201

Misura - Size:
38x53,3 h 71 cm
Piatti - Plate:
(2) 33x26 cm
(2) 29x22 cm

COD33301

Misura - Size:
34x34 h37,5 cm
Piatti - Plate:
Ø34 - Ø26 - Ø15,5 cm
Distanza tra ripiani 11 cm
Distance between shelves 11 cm



COD60501

Misura - Size:
h41 cm
Piatti - Plate:
49x49 - 39x39
29x29 - 19x19 cm
Distanza tra ripiani 12 cm
Distance between shelves 12 cm

COD. 603

Misura - Size:
h 58 cm
Piatti - Plate:
Ø 50 - 42 - 34
Ø 26 - 18 cm



COD. 312

Misura - Size:
h 72 cm
Piatti - Plate:
65x57 - 42x48
34x39 - 25x29 cm

COD33401

Misura - Size:
42x42 h 30,5 cm
Piatti - Plate:
Ø42 - Ø37 - Ø25 cm
Distanza tra ripiani 12 cm





COD33501

Display in plexiglass satinato e bianco
Satin-finish and white plexiglass display

Misura - Size: h 50,5 cm

Piatti - Plate:

63,5 x 35 - 52,5 x 25,5 - 43x21,5 - 35x19 - 28x14,5 cm

Distanza tra ripiani 12 cm

Distance between shelves 12 cm



COD35101

Misura - Size: h38 cm
 Piatti - Plate: 50x50 h.12
 36x36 h.12 - 22,5x22,5 h. 12 cm



COD. 510

Misura - Size:
 41x41 - h 67 cm
 Piatti - Plates:
 40x40 - 35x35 cm
 30x30 - 20x20 cm



COD. 305

Misura - Size:
 Ø 28 h29 - 38x30 h21
 38x30 h13 - 38x30 h5 cm



COD. 307

Misura - Size:
 40x27 h29 - 40x27h 21
 40x27 h13 - 40x27 h5 cm



COD. 32901

Misura - Size:

35x55,5 h27 cm

Piatti - Plate: 35x25 - 30x12 - 28x18 cm

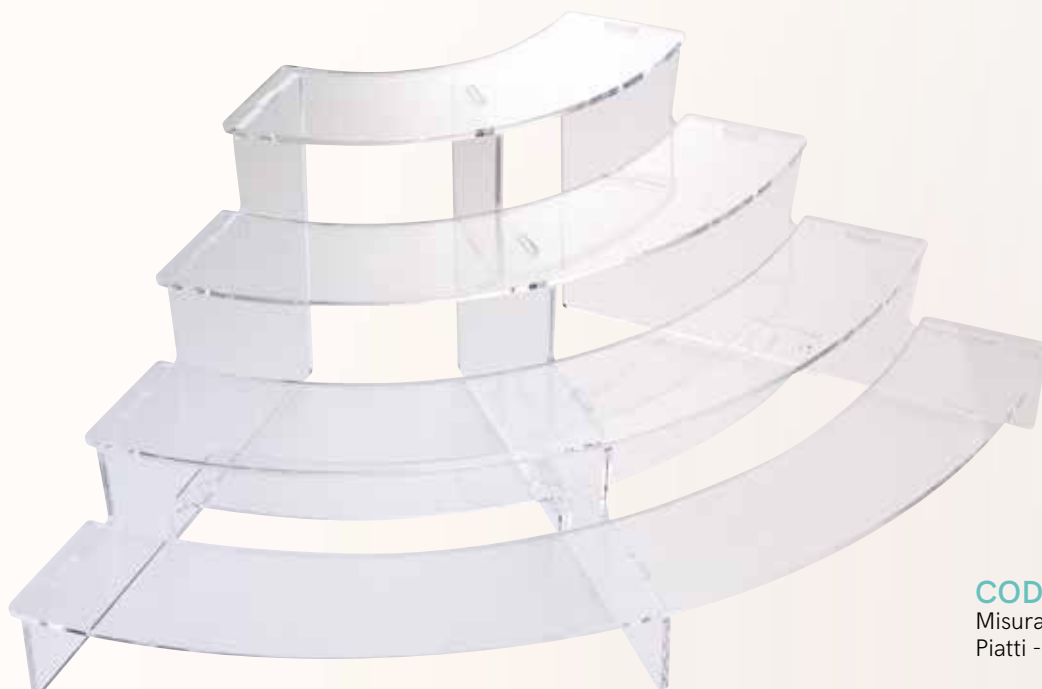

COD. 320

Misura - Size: h 22,5 cm
Piatti - Plate: 65x35,5 cm



COD33701

Piatti - Plate: 50x20 h20,5
50x20 h14 - 50x20 h7 cm

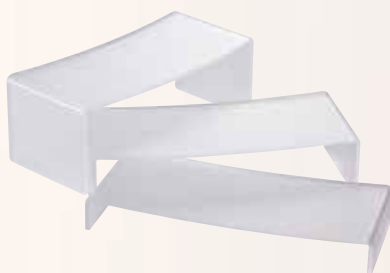

COD33906

Satinato - Satin-finish plexiglass
Piatti - Plate: 35,5x17 h22
57x17 h9 - 40x17 h5 cm



COD. 310

Misura - Size:
40x20 h12 - 40x18 h8 - 40x16 h4 cm



COD. 309

Misura - Size: h 4 - 11 - 18 - 25 cm
Piatti - Plate: 24,5x24,5 cm



COD34001

Piatti - Plate: 49x15,5 h18 - 49x15,5 h13 - 49x15,5 h8 cm

COD32108

Nero - Black
Misura - Size:
56x35 - h 59 cm



COD32100

Bianco - White
Misura - Size:
56x35 - h 59 cm



COD. 321

Arancione - Orange
Misura - Size:
56x35 - h 59 cm

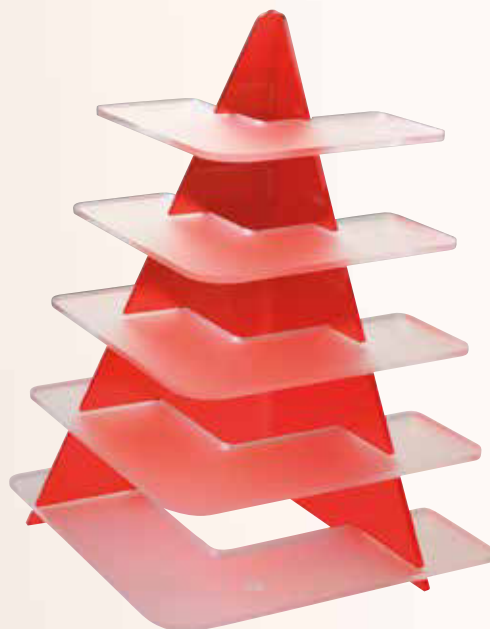

COD. 32418

Rosa - pink

COD. 32416

Marrone - Brown

Misura - Size:
45x30 h61 cm
Piatti - Plate:
32x24 (x3) cm



COD. 308

Misura - Size:
40x40 - h 53 cm
Piatti - Plate:
40x40 - 30x30 -
22x22 cm

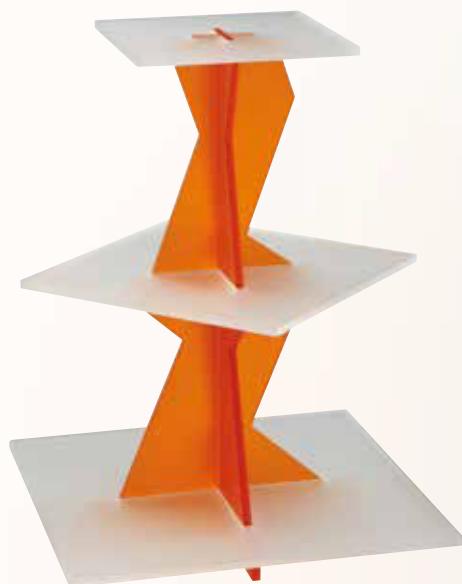

COD. 300

Misura - Size:
54x47 - h 63 cm
Piatti - Plate:
47x34 - 37x25 -
27x17 - 23x13 cm

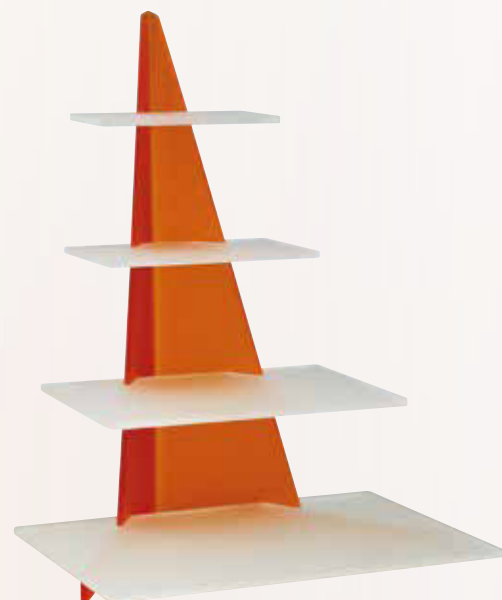

COD. 322

Misura - Size:
h 49,5 cm
Piatti - Plate:
Ø40,5 - 39 - 38
35,5 - 31,5 cm



COD. 301

Misura - Size:
70x40 - h 62 cm
Piatti - Plate:
70x40 - 63x35
52x26 - 42x21 cm



COD. 33118

Rosa - pink

COD. 33101

trasparente - transparent

Misura - Size:
h 3,6 - 11 - 17,6 - 25 cm
Piatti - Plate:
24,5x24,5 cm







COD30400
Bianca - White

COD30408
Nero - Black

COD. 304
Verde - Green

Misura - Size:
56 - h 62 cm
Piatti - Plate:
Ø 56 - Ø 46
Ø 33 - Ø 22 cm



COD33608

Misura - Size:
65x35 h 27 cm
Piatti - Plate: 37x26 - 30x22 - 22x16 cm



COD. 32717

Lilla - Lilac
Misura - Size: 52x43,5 - h 62 cm
Piatti - Plate: 34x18 - 43x23
46,5x25,5 - 42,5x23,5 cm



COD. 303

Misura - Size: 60x50 - h 60 cm
Piatti - Plate: 60x43 - 49x35
27x37 - 25x18

FOLD

Espositori per finger food in plexiglass.
Plexiglass finger food display.



FOLD SINGLE
80D0900

Ingombro/total size
32,5x33,5 h 18 cm

Superficie di appoggio/support
surfaces 16,5x32,5 cm



FOLD DOUBLE
80D1000

Ingombro/total size
65x33,5 h 18 cm
Superficie di appoggio/support
surfaces 16,5x65 cm



CROSS

Espositori in plexiglass per torte e finger food.
Cakes and finger food display made of plexiglass.



CROSS SMALL

80D0200

25x25 h 13,5 cm



CROSS BIG

80D0300

30x30 h 18,5 cm



CROSS DOUBLE

80D0400

20x49,5 h 13,5 cm



CROSS KIT

80D0100

kit 3 displays

25x25 h 13,5 cm

30x30 h 18,5 cm

49,5x20 h 13,5 cm

MOSAIC

Espositori in plexiglass per torte e finger food.
Cakes and finger food display made of plexiglass.



MOSAIC 4
80D0600

ø 24 cm h 4,5 cm



MOSAIC 8
80D0700

ø 24 cm h 8,5 cm



MOSAIC 12
80D0800
ø 24 cm h 12,5 cm



MOSAIC KIT
80D0500
kit 3 displays
ø 24 cm h 4,5 - 8,5 - 12,5 cm

STAIRWAY

STAIRWAY e LEVELS: due diversi display per diverse esigenze espositive.
Componibili in infinite varianti per creare originali effetti coreografici.



STAIRWAY

80D1900

4 Piani - Levels
35x35 h 26 cm
30x30 h 21 cm
25x25 h 16 cm
20x20 h 12 cm



LEVELS

STAIRWAY and LEVELS: two different displays for different exposition needs. Combinable in endless variations, they can offer original coreographic effects.

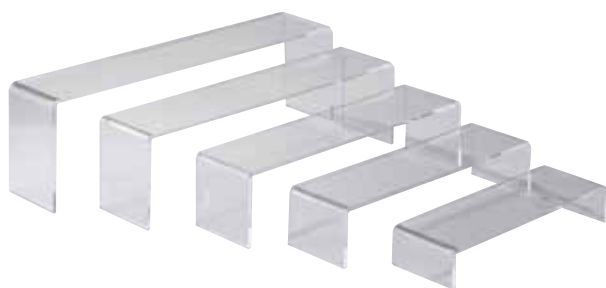

LEVELS

80D2000

5 piani/levels

50x10 h 15 cm - 45x10 h 12,5 cm

40x10 h 10 cm - 35x10 h 7,5 cm

30x10 h 5 cm

LOOP





Serie di alzate in plexiglass **componibili** con elementi **intercambiabili** dal design moderno ed elegante.

Da 3 a 5 piani a cerchio o semicerchio, con **colonne di diverse altezze** che grazie al kit possono comporre diversi disegni estetici.

An elegant and modern design serie of plexiglass **modular** cake stands with **interchangeable** elements.

From 3 to 5 circle or half circle shaped shelves, with little **columns of different heights** that can create different esthetic designs.

LOOP 5

80A1400

5 Piatti - Plates Ø26 cm

Columns:

1x h10 - 2x h18 - 2x h26 cm

Dimension: Ø 77 h26 cm



LOOP 3

80A1500

3 Piatti - Plates Ø26 cm

Columns:

1x h10 - 1x h18 - 1x h26 cm

Dimension: Ø 65 h26 cm



DEMI LOOP

80A1600

3 Piatti - Plates Ø26 cm

Columns:

1x h10 - 1x h22 - 1x h35 cm

Dimension: 65x45,5 h35 cm



Kit complementari disponibili nella pagina seguente
Complementary kits available on the following page

LINEAR



Alzate componibili con elementi intercambiabili essenziali e minimalisti per esaltare l'esposizione delle creazioni. Adatte ai buffet ed alle vetrine. Le diverse misure ed altezze delle colonne le rendono modificabili e adatte a tutte le situazioni.

Essential and minimalist **modular** cake stands with **interchangeable elements** that enhance the exposition of creations. They are suitable either to buffets and showcases. The different sizes and heights of the **columns** make them **changeable** and suitable for all situations.

LINEAR 3

80A1700

3 Piatti - Plates

Columns: 1x h10 - 1x h18 - 1x h26 cm

Dimension: 88x26 h26 cm



LINEAR 5

80A1800

5 Piatti - Plates

Columns: 2x h10 - 2x h18 - 2x h26 cm

Dimension: 140x26 h26 cm



KIT elementi intercambiabili per le alzate LOOP e LINEAR Interchangeable KITS to LOOP and LINEAR models



80RIC04

5 PCS
20x20 cm



80RIC02

5 pcs
ø26 cm



80RIC03

5 pcs
2x ø20 - 2x ø25 - 1x ø30 cm



80RIC05

6 pcs
2x10 - 2x18 - 2x 26 cm

INFINITY



Alzata realizzata completamente in plexiglass,
con un numero di **ripiani regolabili** da 1 a 7
per soddisfare le diverse esigenze.

24 colonnine che grazie alla dima potranno
facilmente essere inserite per comporre la torta.

Catering display entirely made of plexiglass,
with a number of **adjustable shelves** from 1 to 7
in order to satisfy different needs.

24 little columns that can be easily inserted to
compose the cake, thanks to the guide template.



INFINITY 7

80A1300

7 Piatti - Plates

Ø16 - Ø20 - Ø24 - Ø28 - Ø32 - Ø36 - Ø40 cm

Columns: 24 x h10 cm

Dimension: Ø 40 h69 cm



dima in plastica per il centraggio delle colonne inclusa
plastic template for columns placement included

80RIC01

KIT 24 colonnine supplementari

24 supplementary columns

h 10 cm



BAROQUE





Romantiche nello stile e moderne nel materiale, queste alzate sono perfette per qualsiasi occasione, anche grazie alla gamma di colori. I **singoli elementi** possono, a seconda delle necessità, **comporsi in modo diverso** adattandosi agli spazi ed alle situazioni.

With a romantic style and modern materials, these cake stands are perfect in any occasion, thanks to its range of colours. **The individual elements** can, according to need, **compose themselves in different ways**, adapting to spaces and situations.



CRYSTAL BAROQUE

80A1100

5 Alzate - Displays
Ø 26 cm - 1 x h35 - 4x h 21cm

80A0900

1 Alzata - Display
Ø 26 cm h 21cm

80A1000

1 Alzata - Display
Ø 26 cm h 35cm



BLACK BAROQUE

80A1108

5 Alzate - Displays
Ø 26 cm - 1 x h35 - 4x h 21cm

80A0908

1 Alzata - Display
Ø 26 cm h 21cm

80A1008

1 Alzata - Display
Ø 26 cm h 35cm

BAROQUE

Non solo torte, ma anche monoporzioni, mignon e finger food trovano nella versione display del modello Baroque la loro esaltazione.

Not only cakes, but also individual desserts, mignon and finger food find their celebration in the Baroque display version.





BLACK BAROQUE DISPLAY
80D1208

BLACK
3 piani - levels - 25 x 52 cm
primo - first: h 4,8 cm
secondo - second: h 20 cm
terzo - third: h 35 cm



CRYSTAL BAROQUE DISPLAY
80D1200
TRANSPARENT

MINI BAROQUE

Piatto - Plate: 210mm



Nero - Black

80-0108 h 10,5 cm

80-0208 h 16,5 cm

80-0308 h 22,5 cm



Satinato - Glazed

80-0106 h 10,5 cm

80-0206 h 16,5 cm

80-0306 h 22,5 cm

CAKE STANDS

Elegante alzata in plexiglass **modulabile**. Il numero di piatti e la loro disposizione possono essere variati a seconda delle necessità.

Elegant **modular** plexiglass cake stand. The number of plates and their arrangement can be varied as needed.



SQUARE

Piatti - Plates:
25 x 25 - 30 x 30 cm
35 x 35 - 40 x 40 cm
Porz. - Portions: 80 - 85



COD. 130

Misura - Size: h 80 cm

ROUND

Piatti - Plates:
Ø 24 - Ø 29 - Ø 34 - Ø 39 cm
Porz. - Portions: 40 - 50



COD. 131

Misura - Size: h 80 cm

HEART

Piatti - Plates:
25 x 21 - 30 x 26 - 35 x 30 - 40 x 34 cm
Porz. - Portions: 40 - 50



COD. 132

Misura - Size: h 80 cm

ELEGANT

Piatti (spazio espositivo utile)/
plates (usable display space)
ø 20 - ø 23,5 - ø 26,5 - ø 30 - ø 34 - ø 38 cm



80A1900

Misura - Size: h max 1053 cm
Distanza tra i piatti/shelf
spacing 16,5 cm



4 PLATES

Piatti - Plate:
20 - 26 - 32 - 38 cm

COD513
Misura - Size:
70x65 h56 cm

MODULAR DISPLAY



3 PLATES

Piatti - Plate:
20 - 26 - 32 cm

COD512

Misura - Size:
67x37 h21 cm



5 PLATES

Piatti - Plate:
20 - 26 - 32 cm

COD514

Misura - Size:
100x53 h39,5 cm

ALZATE componibili

Combinando tra loro le alzate si possono avere le composizioni più adatte alle proprie necessità.
By combining the stands you will have the compositions best suited to your needs.

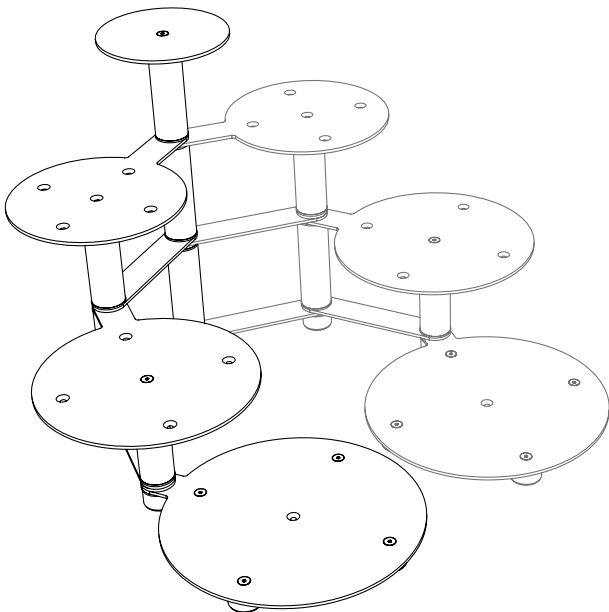

COD513 + COD513

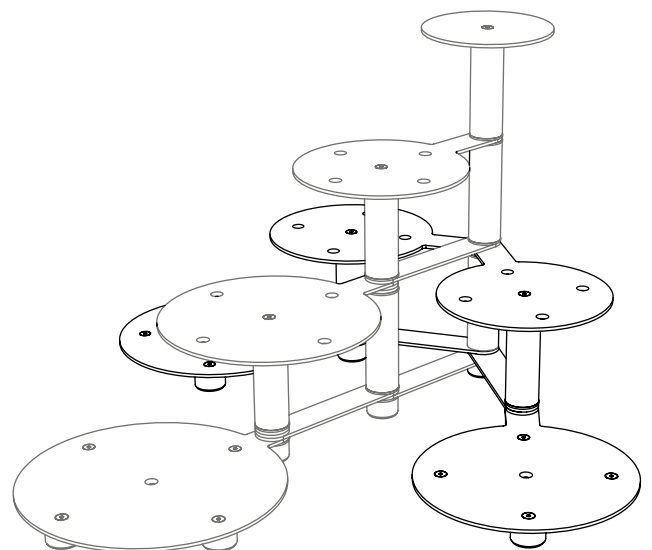

COD513 + COD514



ROMANTIC

Piatti - Plates:
Ø 20 - 22 - 26 - 28 - 30 cm

COD. 504

Misura - Size: h 125 cm
Piatti in plexiglass satinato
Satin-finish plexiglass plate

FLORA

Piatti - Plates:
4x Ø 34 - 7 x Ø 26 - 1 x Ø 32 cm
Porz. - Portions: 145 - 155

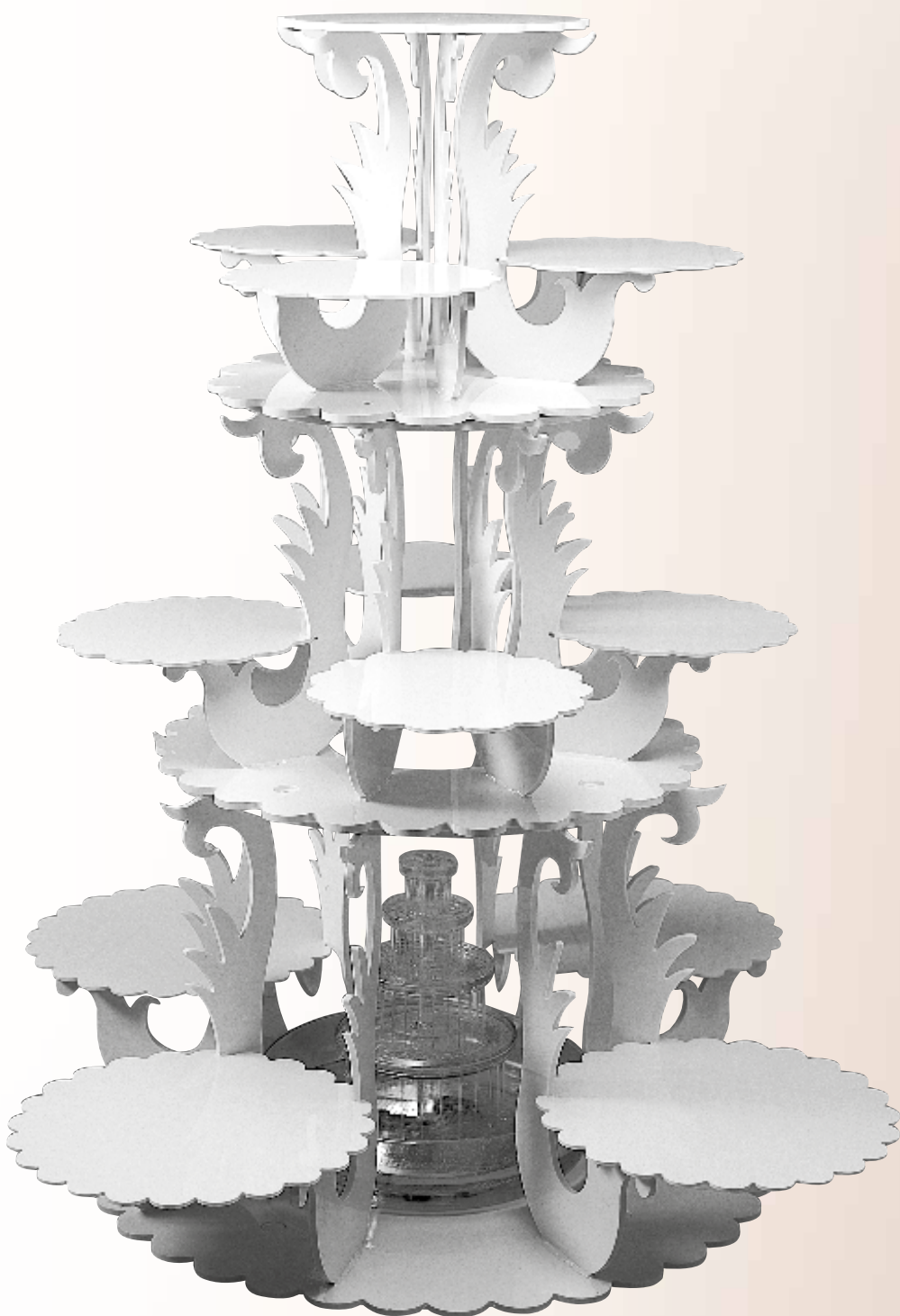

Complete
COD. 160

Misura - Size: Ø 110 h130 cm
FONTANINA non inclusa - not included



Small

COD. 163

Misura - Size:
Ø 40 h45 cm

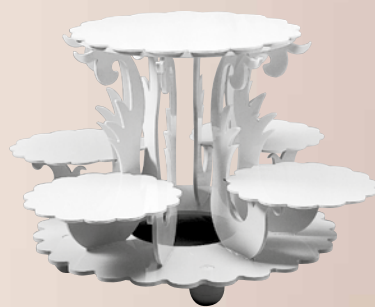

Medium

COD. 162

Misura - Size:
Ø 70 h42 cm



Large

COD. 161

Misura - Size:
Ø 110 h51 cm

FONTANINA
non inclusa / not included

GRADUS

Piatti - Plates:
22 - 22 - 24 - 26 - 28 cm
Porz. - Portions: 45 - 55



COD. 190

Misura - Size: 88 x 30 h 43 cm

MEMPHIS

Porz. - Portions: 50 - 60



COD. 183

Misura - Size: Ø 70 h 50 cm

CLOVER

Piatti - Plates:
3 x Ø 28 - 3 x Ø 20 - 1 xl Ø 22 cm
Porz. - Portions: 40 - 45



COD. 188

Misura - Size: 65x62 h 38 cm

DAISY

Piatti - Plates:
6 x Ø 28 - 1 x Ø 48 - 1 x Ø 30 cm
Porz. - Portions: 120 - 130



COD. 180

Misura - Size: Ø 90 h 45 cm

ROMANTICA

Piatti - Plates:
5 x Ø 26 - 5 x Ø 20 - 1 x Ø 34 cm
Porz. - Portions: 100 - 110



COD. 152

Misura - Size: Ø 80 h 70 cm

SEMIRAMIDE

Piatti - Plates:
3 x Ø 32 - 3 x Ø 26 - 1 x Ø 38 cm
Porz. - Portions: 90 - 100



COD. 153

Misura - Size: 100 x 54 h 88 cm

MANHATTAN

Piatti - Plates:
6 x Ø 26 - 1 x Ø 38 cm
Porz. - Portions: 100 - 110



COD. 159

Misura - Size: Ø 65 h 85 cm

MILANO

Piatti - Plates:
4 x Ø 20 - 1 x Ø 25 cm
Porz. - Portions: 30 - 35



COD. 192

Misura - Size: 62 x 62 h 38 cm

STAIRWAY

Piatti - Plates:
23x18 - 29x17 - 39x19 - 50x22 - 60x25 cm
Porz. - Portions: 75 - 85



COD. 150

Misura - Size: h 80 cm

PARIS

Piatti - Plates:
62 x 62 - 41 x 41 - 31 x 31 - 19 x 19 cm
Porz. - Portions: 85 - 95

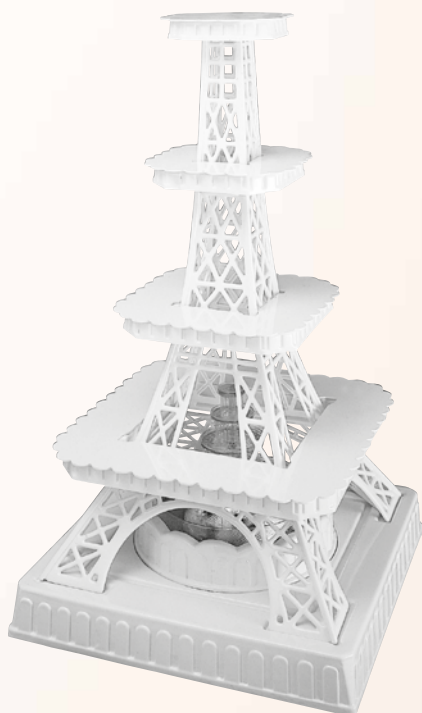

COD. 127

Misura - Size: 73 x 73 h 140 cm
FONTANINA non inclusa - not included
Base with separator ring included

CONE



COD. 185

Misura - Size: Ø 62 h 50 cm
Base: Ø 62 cm



COD. 184

Misura - Size: Ø 52 h 40 cm
Base: Ø 52 cm

THREE

Piatti - Plates:
Ø 26 - h 1,5 cm



COD. 402.01

Misura - Size: Ø 56 - h 57 cm

PLASTIC DUMMIES



Tamburi in plastica. Ideali per realizzare wedding cake di grandi dimensioni.
Plastic cake dummies. Ideal for creating large wedding cakes.

Tamburi Dummies

Size cm	Codice - Code
h 10 - Ø20	40-W110
h 10 - Ø30	40-W111
h 10 - Ø40	40-W112
h 10 - Ø50	40-W113

Set 4 tamburi Set 4 dummies 40-W106

Misura - Size: Ø 50- 40 - 30 - 20 cm

Cerchi inox per tamburi St steel rings for dummies

Size cm	Codice - Code
h 5 - Ø19,5	40-W087
h 5 - Ø29,5	40-W088
h 5 - Ø39,5	40-W089
h 5 - Ø49,5	40-W090

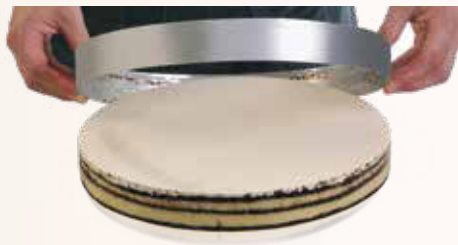

Piatto antiscivolo Non-slip plate 40-W124

Misura - Size: Ø58 cm



Pioli per torta - Cake dowel rods 40-W101

Misura - Size: Ø6 mm
Pack 50 pcs



Pioli per torta - Cake dowel rods 40PI01

Ø 16 - 300mm
Pack 12Pz



Kit taglia pioli - Cutter kit 40KIT01

Pioli, seghetto e dima
Plastic dowel rods, hacksaw and support

Misura Size cm	Porzioni Portions	Piani Levels	Code METAL	Code PLASTIC
Ø 20 - 26 - 32	34-36	3	METAL3	80-2003
Ø 20 - 26 - 32 - 40	60-62	4	METAL4	80-2004
Ø 20 - 26 - 32 - 40 - 45	90-92	5	METAL5	80-2005
Ø 20 - 26 - 32 - 40 - 45 - 50	130-132	6	METAL6	80-2006
Ø 16 - 20 - 26 - 32 - 40 - 45 - 50	175-180	7	METAL7	80-2007
Ø 16 - 20 - 26 - 32 - 40 - 45 - 50 - 55	220-225	8	METAL8	80-2008
Ø 16 - 20 - 26 - 32 - 40 - 45 - 50 - 55 - 60	270-280	9	METAL9	80-2009

Alzate multipiano disponibili nella versione in metallo (METAL)
e in resistente plastica bianca (PLASTIC).

Multi level cake stands available in metal version (METAL)
or in resistant white plastic (PLASTIC)



plastic

metal

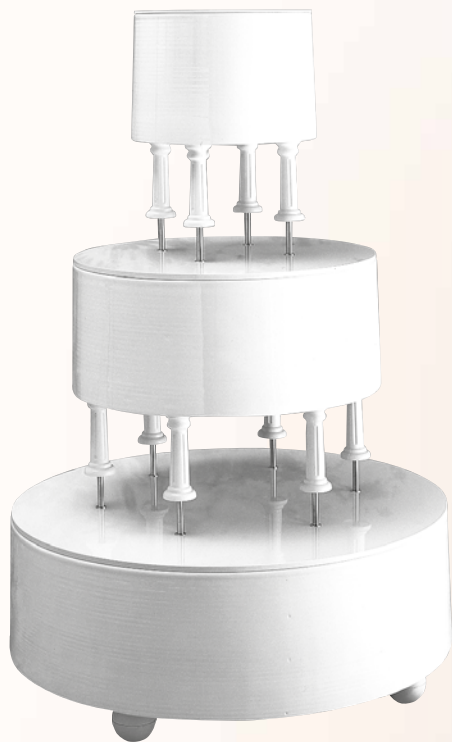

COD. 158

Misura - Size: h 105 cm

Piatti - Plates:
Ø 28 - 48 - 68 cm

Porz. - Portions: 105 - 115



COD. 155

Misura - Size: h 65 cm

Piatti - Plates:

Ø 28 - 48 - 68 cm

Porz. - Portions: 60 - 70



Tonda - Round

COD. 201

Misura - Size: Ø 49 h 58 cm

Piatti - Plates:
Ø 49 - Ø 33 - Ø 17 cm



Ovale - Oval

COD. 202

Misura - Size: 51x41 h 58 cm

Piatti - Plates:
51x41 - 35x25,5 - 19,5x10 cm



Rettangolare - Rectangular

COD. 203

Misura - Size: 50x41 h 58 cm

Piatti - Plates:
50x41 - 35x25 - 19x9 cm



Quadrata - Square

COD. 204

Misura - Size: 49x49 h 58 cm

Piatti - Plates:
49x49 - 33x33 - 17x17 cm

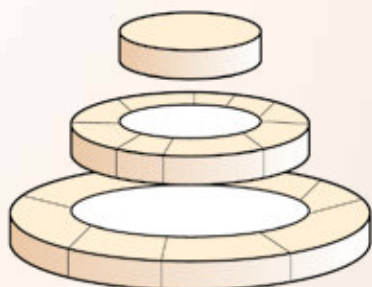

Preparare la base del pan di spagna da sagomare con l'aiuto dei piatti in plastica in dotazione in ogni Little Wedding Cake;

Prepare the sponge cake base to be shaped by using the plastic plates supplied with every Little Wedding Cake;

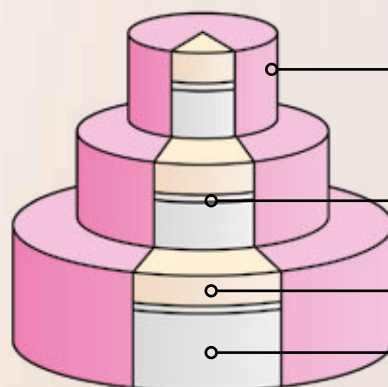

Copertura di pasta zucchero
Sugarpaste coat

Piatto in plastica
Plastic plate

Dolce / Cake

Tamburi / Dummies

CARRÈ

Piatti - Plates:
 25 x 25 - 30 x 30 - 35 x 35
 40 x 40 - 45 x 45 cm
 Porz. - Portions: 145 - 155



COD. 102

Misura - Size: h 96 cm



COD. 101

Misura - Size: h 120 cm
 FONTANINA non inclusa - not included

CIRCLE

Piatti - Plates:
 Ø 25 - 30 - 35 - 40 - 48 cm
 Porz. - Portions: 100 - 110



COD. 104

Misura - Size: h 86 cm



COD. 103

Misura - Size: h 120 cm
 FONTANINA non inclusa - not included

ACCESSORIES



Small column
COLONNINA
 13 cm

Big column
COLONNA
 35 cm



Electric fountain
FONTANINA - 12V
 Misura - Size: Ø38 - h 40 cm

MULTI ICE revolution

Multi Ice Revolution. Stampi in speciale materiale plastico per realizzare splendide sculture in ghiaccio.

Multi Ice Revolution. Moulds made of special plastic to create spectacular ice sculptures.



MIR07

Sculpture: 41x41 h 83cm
Mould: 51x41 h 96cm - 9kg



MIR04

Sculpture: 48x56 h 15cm
Mould: 60x61 h 15cm - 7kg



MIR16

Sculpture: Ø40 h 20cm
Mould: Ø52 h 23cm - 4kg



MIR17

Sculpture: Ø39 h 15cm
Mould: Ø53 h 19cm - 4,5kg



MIR01

Sculpture:
42x26 h 53cm
Mould: 60x25 h
65cm - 7kg



MIR02

Sculpture:
47x26 h 56cm
Mould: 67x29 h
62cm - 8kg



MIR05

Sculpture:
36x26 h 67cm
Mould: 50x26 h
78cm - 7,5kg



MIR08

Sculpture:
58x25 h 56cm
Mould: 69x25 h
70cm - 8kg



MIP

La pompetta tiene in movimento l'acqua all'interno dello stampo durante il processo di congelazione. Con l'aiuto di questo accessorio la scultura di ghiaccio risulterà più trasparente.

The Air pump makes the water circulate inside the mould during the process of freezing. With the help of this accessory, the resulting ice sculpture will be more transparent.



**Supporto per pompetta
Air pump support**

Suitable for	Code
MIR02	MIS02
MIR05	MIS05
MIR08	MIS08



INDICE ALFABETICO

ITALIANO

Descrizione	Pag
ACETATI PVC	233
ADATTATORI BOCCHETTE	335
AEROGRAFI	390
AGHI PANETTONE	227
ALZATE TORTA	448
BICCHIERINI E COPPETTE	420
BILANCE	309
BOCCHETTE	329
BOTTIGLIE	364
CAKE DESIGN	382
CAKE IDEA	206
CANNELLI	381
CANNOLI	358
CAPPELLI	375
CARAFFE	368
CARAMELLOMETRO	381
CARTA FORNO	358
CESTINI PANE	371
CHABLON DECORATIVI	108
CHITARRE	288
CIOTOLE	369
COLINO	307
COLORANTI ALIMENTARI	400
COLTELLI	348
COMUNIONE, CRESIMA	175
CONTENITORI	310
COPERCHI	304
COPERTURE CARRELLI	376
COPPETTE	420
DECORAZIONE, ATTREZZI	90, 104
DECORO CROSTATE, STAMPO	359

Descrizione	Pag
DESSERT IDEA	234
DIME	365, 356
ECLAIR	250, 199
ESPOSITORI BUFFET	432
ESPOSITORI MACARON	312
FASCE INOX	214
FETTA, STAMPO	232
FLACONI	364
FONTANE PER CIOCCOLATO	184
FORCHETTINE PER CIOCCO	176
FRUSTE	343
GELATI, STAMPI	254
GELATINE, STAMPI	249
GHIACCIOLI, STAMPI	254
GIRAPANETTONI	227
GIRATORTA	300
GRATTUGIE	349
GRIGLIE	351
GRIGNOTTINA	308
GUANTI	374, 381
HALLOWEEN, STAMPI	170
LAMPADA DA ZUCCHERO	380
LEVEL, STENDI IMPASTO	278
LIRA	359
LOLLIPOP	88
MACARON	250
MART CUTTER, TAGLIANASTRI	284
MATRIMONIO, STAMPO SILICONE	172
MICROFORATI	192
MIGNON	229

Descrizione	Pag
MONOPORZIONI	230
NAPOLITAIN	73
NASCITE E BATTESIMI	174
NATALE	122
NUMERI	226, 387
ONE STRIP STAMPO SEMIFREDDO	200
PACKAGING	177
PALA PER DOLCI	302
PALLINATORE	308
PANDORI, STAMPO	227
PANE, STAMPI	370
PENNELLI	350
PETTINI DECORATIVI	396
PIASTRA RISCALDANTE	282
PIATTINI	428
PINZE	349, 350
PORZIONATORI, GELATO	269
PRALINE	14
RAPLETTE	357
RASCHIETTI	345
RIFRATTOMETRO	309
RIGA	365
RULLI	355
RULLI FORAPASTA	353
S. VALENTINO	168
SAC A POCHE	322
SCIOGLITORI	178
SCULTURE GHIACCIO	469
SEGNAGUSTO	271
SEGNAPORZIONI	359
SEGNAPREZZO	375
SEMIFREDDI, STAMPI	200, 206, 228
SEMISFERE	82
SESSOLE	369
SETACCI	351
SIFONE	306

Descrizione	Pag
SILICONE, STAMPI	240
SNACK	63
SOGGETTI IN CIOCCOLATO	112
SOTTOTORTA	377
SPATOLE	338
SPATOLE GELATO	268
SPAZZOLE	373
STENCIL DECORO	392, 395
STENDIPASTA	303, 278
TAGLIA CROISSANT	354
TAGLIABISCOTTI	362
TAGLIAPASTA	360
TAGLIAPASTA ESTENSIBILE	352
TAGLIERE	365
TAGLIERINI	372
TAMBURI PER TORTE	466
TAPPETI ANTIADERENTI	367
TAPPETI DECORO	397
TAPPETI IN SILICONE	367
TAVOLE MULTIUSO	376
TAVOLETTE	42
TEGLIE	366
TELAI GANACHE	298
TELI LIEVITAZIONE	371
TERMOMETRI	309
TORTIERE SILICONE	248
TRAVEL CAKE	188
TRONCHETTI	236
UOVA DI CIOCCOLATO	144
VASCHETTE GELATO	266
VASSOI	319
VETRINE	315
ZESTER	349

ALPHABETICAL INDEX

ENGLISH

Description	Pag
ADAPTERS, PIPING TIPS	335
AIRBRUSH COMPRESSOR	390
BAKING PAPER	358
BAKING TRAY	366
BALL MACHINE	308
BARS CHOCOLATE MOULDS	42
BOTTLES, GRADUATED	364
BOWLS	369
BREAD BASKETS	371
BREAD MOULDS	370
BREAD SHEETS	371
BRUSHES	350
BRUSHES	373
CAKE BOARDS	376
CAKE DESIGN	382
CAKE IDEA	206
CAKE LIFTER	302
CAKE MARKERS	359
CAKE MOULDS, SILICONE	248
CAKE SLICER	359
CAKE STANDS	448
CAKE TURNTABLE	300
CANNOLI MOULD	358
CARAFES	368
CARAMELLOMETER	381
CATERING DISPLAYS	432
CHABLON	108
CHOCOLATE FOUNTAINS	184
CHOCOLATE MELTERS	178
CHRISTMAS MOULDS	122
COLOURANT, FOOD	400

Description	Pag
COMBS	396
CONTAINERS	310
COOKIES GRID	362
COOKIES MAKER	308
CREAM WHIPPER	306
CROISSANT CUTTER	354
CUPS, PLASTIC	420
CUTTER	372
CUTTERS, SET	360
CUTTING BOARD	365
CUTTING DOCKERS	353
DECORATING TOOLS	90, 104
DECORATIVE STENCIL	392, 395
DESSERT CUPS	420
DESSERT IDEA	234
DIPLAY CASE	315
DISHES, PLASTIC	428
DISPOSABLE SEMIFREDDO MOULDS	200
ECLAIR	250, 199
EGGS MOULDS	144
EXPANDING PASTY CUTTERS	352
FIGURES, MOULDS	112
FLOUR SCOOP	369
FORK, CHOCO	176
FRAME FOR GANACHE	298
GLOVES	374, 381
GRATERS	349
GUITARS CUTTER	288
HALLOWEEN MOULD	170
HATS, CHEF	375
HOLY SACRAMENTS	175

Description	Pag
ICE CREAM BASIN	266
ICE CREAM FLAVOUR MARKER	271
ICE CREAM MOULD	256
ICE CREAM SCOOP	269
ICE CREAM SPATULAS	268
ICE LOLLY MOULD	254
ICE SCULPTURES	469
INDIVIDUAL PORTION MOULD	230
JELLY MOULDS	249
KNIVES	348
LEAVENED DOGHS SUPPORT	227
LEVEL, DOUGH SPREADER	278
LIDS COVER	304
LOG MOULDS	236
LOLLIPOP	88
MACARON	250
MACARON DISPLAY	312
MAT, SILICON	367
MATS, DECORATIVE	397
MATS, NO STICK	367
MICROFORATI	192
MIGNON	229
NAPOLITAIN MOULDS	73
NEW BORN THEME MOULDS	174
NUMBER MOULD	226, 387
PACKAGING	177
PANDORO, MOULD	227
PANETTONI TURNING ROD	227
PASTRY BAGS	322
PINCERS	349, 350
PIPING TIPS	329
PISTON FUNNEL	307
PLASTIC DUMMIES	466
PLASTIC RIBBONS /SHEETS	233
PRALINE	14

Description	Pag
PRICE CARDS	375
RACKS	351
RAPLETTE	357
REFRACTOMETER	309
RIBBON CUTTER	284
ROLLING MACHINE	303, 278
ROLLING PINS	355
RULERS	365
SCALE	309
SCRAPERS	345
SEMIFREDDO MOULDS	200, 206, 228
SEMISPHERE MOULDS	82
SIEVES	351
SILICONE, MOULD	240
SLICE, STAMPO	232
SNACK CHOCO MOULDS	63
SPATULAS	338
STAINLESS STEEL BANDS	214
SUGAR LAMP	380
THERMOMETERS	309
TORCH, CHEF	381
TRAVEL CAKE	188
TRAYS	319
TROLLEY COVER	376
VALENTINE'S DAY	168
WARMING PLATE	282
WEDDING THEME MOULDS	172
WHISKS	343
ZESTER	349

INDICE NUMERICO

NUMERICAL INDEX

Cod.	Pag	Cod.	Pag	Cod.	Pag
29003	89	15H4X25 / 15H4X34	223	20CO01	129
104000	259	18H4X17 / 18H4X26	220	20CO02	129
104001	259	18H5X17 / 18H5X26	220	20CT01	128
104002	257	1H25X14 / 1H25X24	217	20EC01	25
104003	257	1H2X8 / 1H2X28	217	20EC02	250
10-E002	261	1H35X14 / 1H35X24	217	20FH01L	91
105000 / 105003	261	1H4X8 / 1H4X30	217	20FH01S	91
10CG01 / 10CG04	269	1H5X10 / 1H5X30	217	20FH02L	92
10E006 / 10E007	257	1H6X6 / 1H6X22	217	20FH02S	92
10PG01 / 10PG05	269	20-1010 / 20-1011	120	20FH03L	93
10SA001B	271	20-3D1001 / 3D6001	79	20FH03S	93
10SA001N	271	20-C024	140	20FH04	91
10SEG	270	20-C1000	140	20FH05	92
10SEG05	270	20-C1001	140	20FH06	93
10SEG06	271	20-C1002	140	20FH07L	90
10SEGB	271	20-C1010	140	20FH07S	90
10SG00 / 110SG00	268	20-C1955 / 20-C1957	161	20FH30L	99
10SGC00 / 10SGC100	268	20-CU001	165	20FH30S	99
10SI001B / 10SI002B	270	20-D001 / D029	105/107	20FH31L	100
10SI001N / 10SI002N	270	20-S001 / 20-S003	89	20FH31S	100
10SL072	257	20-U1010	164	20FH32L	99
10SL114	257	20-U1011	164	20FH33L	99
10VP0801 / 0802	268	203D01 / 203D04	81	20FH34L	99
10VP1201 / 10VP1202	268	20A3D01	130	20FH35L	101
11H4L24 / 11H4L40	224	20A3D02	130	20FH36L	101
11H5L24 / 11H5L40	224	20BA01	116	20FH36S	101
13H4X15 / 13H4X30	223	20BC100	135	20FH37L	100
14H4X16 / 14H4X30	223	20CG01	112	20FH37S	100

Cod.	Pag	Cod.	Pag	Cod.	Pag
20FH50	95	20U175N	167	30IDEA01 / 30IDEA06	235
20FH50 / 20FH54	95	20U204N	167	30MICRO01 / 011	198
20FH51	95	20U227N	167	30SILO1N / 30SILO8N	240
20FH52	97	20U258	167	30SM071	119
20FH53	96	20U320	167	30SML002	141
20FH54	96	20U3D01	152	30SML003	169
20FRUIT01 / 05	78	20U3D02	150	30SMT01	118
20GU001 / 20GU007	87	20U3D03	151	30SMTP01	173
20GU008	86	20U3D04	150	30SMTP02	173
20GU009	86	20U3D05	151	30SMTP03	173
20GU500 / 20GU502	87	20U3D06	153	30SMTP04	174
20HO01	132	20U3D07	148	30SMTP05	175
20L001 / 20L008	88	20U3D08	148	30SP0100	227
20L004	169	20U500	147	30SP0250	227
20L005	141	20U501	147	30SP0500	227
20L006	172	20U502	144	30SP0750	227
20OB01	114	20U503	144	30SP1000	227
20OR001	155	20U504	145	30TB3S	236
20PA01	116	20UB100	154	30TC50F / 30TC54F	190
20PC01	112	20WT01	113	30TE3001R	250
20PP01	115	21VA085	165	30TE3002R	250
20PR01	133	21VA102	165	30TE6001R	250
20SC01	165	22BOX48	177	30TE6002R	250
20SF001	82	22BOX48T4	177	30TM3001R	251
20SF002	82	22BOX60	177	30TM6001R	251
20SF003 / 20SF008	137	22BOX60T4	177	30TS000 / 30TS016	238
20SI01	114	22BOX85	177	30TT104S	236
20SL01	132	22BOX85T4	177	31CUT01	427
20TC001 / 20TC006	59	23H4X25 / 23H4X35	224	31CUT02	250
20TES001 / 007	239	23H5X25 / 23H5X35	224	31CUT03	265
20U032N	167	27H4X12 / 27H4X16	223	32H4X18S	213
20U064N	167	2H4X10 / 2H4X30	222	32H4X22S	213
20U105N	167	30BANDS01 / 07	195	33H4X20S	212
20U130N	167	30CH001	227	33H4X24S	212
20U150N	167	30H4X01 / 30H4X10	226	33KITH4X20	212

Cod.	Pag	Cod.	Pag	Cod.	Pag
33KITH4X24	212	40-W049S	384	40-WA009	387
34H4X16S	213	40-W051S	385	40-WA010	335
34H4X20S	213	40-W052	388	40-WC015	403
34KITH4X16	213	40-W053	385	40-WC017	403
34KITH4X20	213	40-W055	384	40-WC020	403
35H4X14S	212	40-W056 / W065	377	40-WC117	403
35H4X19S	212	40-W087 / W124	466	40-WC119	403
35KITH4X19	212	40-W108	388	40-WC300 / WC326	402
36H4X22S	211	40-W125	302	40-WC308N	402
36KITH4X22	211	40-W139	389	40-WCB200 / WCB217	411
37H4X22S	210	40-W141	389	40-WD001 / WD006	383
37KITH4X22	210	40-W154	355	40-WF001 / WF012	386
38H4X22S	210	40-W161S	389	40-WM007 / WM506	391
38KITH4X22	210	40-W164A	388	40-WR002	391
39H4X20S	211	40-W166	417	40-WR003	391
39H4X24S	211	40-W167	389	40H4X01 / 40H4X10	226
39KITH4X20	211	40-W188S	385	40KIT01	466
39KITH4X24	211	40-W193C	384	40LCD003	406
3H4X8 / 3H4X10	219	40-W193S	384	40LCD005	406
3H5X6 / 3H5X10	219	40-W194B	384	40LCD007	406
40-W004	388	40-W194C	384	40LCD008	406
40-W010S	389	40-W194S	384	40LCD017	406
40-W013S	389	40-W198V	388	40LCD024	406
40-W014S	389	40-W199V	388	40LCPN202 / 309	414/415
40-W016S	389	40-W200	303	40LCS102	413
40-W021	355	40-W2004S	303	40LCS108	413
40-W022	355	40-W206C	384	40LCS117	413
40-W026	389	40-W206S	384	40LCS417	413
40-W027	385	40-WA001V	387	40LCS419	413
40-W028	385	40-WA002 / WA003	387	40PI01	466
40-W030	385	40-WA004V	394	41H4X9 / 41H4X22	221
40-W031	388	40-WA005V	394	42H4X10 / 42H4X28	220
40-W031R	388	40-WA006V	394	42H5X10 / 42H5X28	220
40-W042	417	40-WA007	388	43H4X18	218
40-W043S	389	40-WA008	387		

Cod.	Pag.	Cod.	Pag.	Cod.	Pag.
43H4X20	218	50CI216040	310	50FLAN2	364
50-1030	325	50CI22X14	358	50FLAN2T	364
50-1040	325	50CI276040	310	50GD0022	365
50-1055	325	50CI316040	310	50GD0027	365
50-1065	325	50CI5050BC	311	50GD0037	365
50-2030	325	50CI5050ES	311	50GD2040	365
50-2040	325	50CI540GN	310	50GD3060	365
50-2055	325	50CI6040	310	50GIRA02	227
50-2065	325	50CIA003	310	50GO275	339
50-3030	324	50CIA007	310	50GO300 / 50GO400	339
50-3040	324	50CIA008	310	50KIT18	207
50-3055	324	50CO001	307	50KIT20	207
50-3065	324	50CO002	307	50LE001	279
50-C015	293	50CO30X12	358	50MC001	284
50-C022	293	50CO35X14	358	50PE30	350
50-C030	293	50CO40X16	358	50PE40	350
50-C045	293	50COL01 / 50COL07	348	50PE50	350
50-CD100N	293	50COL50	372	50PE60	350
50-CS100	293	50COL51	372	50PE70	350
50103020STD	325	50CP01	376	50PI01	349
50104020STD	325	50CS200	291	50PI02	349
50105520STD	325	50CSBA	291	50PI03	349
50AD001	335	50CSTE15	291	50PI04	349
50AD002	335	50CSTE22	291	50PI05	349
50AD003	335	50CSTE30	291	50PP01	381
50AD004	335	50CSTE37	291	50PR002	283
50BI01	309	50CSTE45	291	50QG03	299
50BI02	309	50DF138	356	50QG05	299
50CA604007C	311	50DF158	356	50QG10	299
50CA604010C	311	50DF178	356	50QG15	299
50CA604013C	311	50DF198	356	50RAS1	346
50CA6040COP	311	50DI20 / 50DI34	377	50RAS2	346
50CI12X20	358	50FA01 / 50FA06	343	50RAS4	345
50CI166040	310	50FL00	364	50RAS5	345
50CI16X20	358	50FL00C	364	50RAS6	345

Cod.	Pag	Cod.	Pag	Cod.	Pag
50RAS7	345	50TLMINI	298	53GP01	227
50RI01	309	50TLS03	298	53TA60402	366
50RTA1	347	50TLS05	298	53TA60404	366
50RTA2	347	50TLSPECIAL	298	53TAF40302	366
50RTD1	347	50VA001A	327	53TAF40304	366
50RTF1	347	50VP00402	318	53TAF60404	366
50RTF2	347	50VP0500 / 0808	319	53TL60402	366
50RTL1	347	50VP201008	319	53TL60404	366
50RTL2	347	50VP202008	319	55TP22080	371
50RTO1	347	50VP251208	319	55TP6080	371
50RTO2	347	50VP252508	319	5H25X14 / 5H35X18	219
50RTP1	347	50VP601008	319	5H4X10 / 5H4X30	219
50RTP2	347	50VP602508	319	5H5X10 / 5H5X30	219
50RTS1	347	50WA004B	394	5H6X6 / 5H6X10	219
50RTT1	347	50WA005B	394	70H402 / 70H403	225
50RTV1	347	50WA006B	394	70H602 / 70H603	225
50RTV2	347	50ZES01	349	71H402 / 71H403	225
50SA150B / 250B	341	50ZES02	349	71H602 / 71H603	225
50SC350	338	50ZES03	349	80-0106	457
50SC400	338	51CF6040	358	80-0108	457
50SG250B / 350B	339	51KIT18	208	80-0206	457
50SI01	306	51MA0032	251	80-0208	457
50SI02	306	52BO13PC	369	80-0306	457
50SIR01	306	52BO13PP	369	80-0308	457
50SL300B / 50SL370B	341	52BO17PC	369	80-2003 / 80-2009	466
50SP300B / 400B	340	52BO17PP	369	80A0900	455
50SPA15 / 50SPA30	342	52BO23PC	369	80A0908	455
50SPANG09 / 20	342	52BO23PP	369	80A1000	455
50SPB30	357	52BO28PC	369	80A1008	455
50SPB43	357	52BO28PP	369	80A1100	455
50SR340	340	52BO32PC	369	80A1108	455
50ST01	376	52BO32PP	369	80A1300	453
50T001 / 50T003	309	52BO38PC	369	80A1400 / 80A1600	449
50TLM03	298	52BO38PP	369	80A1700	451
50TLM05	298	52KIT27	209	80A1800	451

Cod.	Pag	Cod.	Pag	Cod.	Pag
80A1900	459	90-2008	163	AR0001	317
80D0100	443	90-2009	163	AR00011	317
80D0200	443	90-2010	163	AR00011B	317
80D0300	443	90-2020	160	AR0001B	317
80D0400	443	90-2026	163	AR02801	317
80D0500	445	90-2102	160	BA 411 / BA 415	332
80D0600	444	90-2114	160	BASKET 102 / 208	371
80D0700	444	90-2316	160	BC 0855	332
80D0800	445	90-2346	160	BC 320 / BC 330	329
80D0900	442	90-2353 / 90-2356	163	BD 300 / BD 302	330
80D1000	442	90-4108	142	BF 0867	329
80D1200	457	90-4109	142	BF 0869	329
80D1208	457	90-4401	142	BF 310 / BF 314	329
80D1900	446	90-4406	142	BF 314/11	329
80D2000	447	90-P9645	121	BF 315 / BF 319	329
80DM01 / 80DM03	312	90-P9661	121	BIM 232	334
80ET007 / 80ET009	61	90-P9662	121	BIM 340	334
80RIC01	453	AG00202N / 208N	274	BIM230	334
80RIC02	451	AG00501 / AG00708	275	BO1000N	364
80RIC03	451	AG00708N	274	BO100N	364
80RIC04	451	AG00902 / AG03306	274	BO250N	364
80RIC05	451	AG05301	275	BO500N	364
8H4X10 / 8H4X30	222	AG05601 / AG05801	313	BOS 26	336
90-1000	121	AG07001 / AG07401	275	BOS 36 BIG	336
90-1001	169	AG07701	313	BOS 52	336
90-1004	169	AG07701P	313	BOS12FLO	333
90-1026	169	AG07901	313	BOSPL 1	335
90-1212	169	AG09002 / AG09003	263	BOSPL 3	335
90-12816	121	AG20245MO	268	BPL 6	335
90-13040	121	AG362512POLB	266	BR 330 / BR 332	332
90-13064	120	AG362512POLN	266	BRU	335
90-13179	121	AG36258POLB	266	BS 0195	332
90-14243	121	AG36258POLN	266	BS 0195K	332
90-15303	121	AGCOP1 / AGCOP3	268	BS 0D6K	332
90-1612	169	AGECMO	267	BS 0F6K	332

Cod.	Pag	Cod.	Pag	Cod.	Pag
BS 10 S	332	CHOCOFORK	176	COD. 307	435
BS 10 T	329	CHOCORING06	185	COD. 308	439
BS 102 / BS 118	329	CIOK 1	308	COD. 309	437
BST100	262	CLP01	255	COD. 310	437
BT 202 / BT 224	329	CLPESPO15	255	COD. 312	433
BX --	330/334	CLPESPO21	255	COD. 320	437
CANNELLO PRO	381	CLPESPOB	255	COD. 321	438
CANNELLOBIG	381	CLPESPOBTRA	255	COD. 322	439
CANNELLOBL	381	COATING	416	COD. 32416	438
CANNOLO	358	COD. 101 / COD. 104	468	COD. 32418	438
CAP 3	375	COD. 127	465	COD. 32717	441
CAP 4	375	COD. 130	459	COD. 32901	436
CAP2B	375	COD. 131	459	COD. 33101	439
CFTRA 1 / CFTRA 6	368	COD. 132	459	COD. 33118	439
CFTRA6C	368	COD. 150	465	COD. 402.01	465
CHASIL 1 / 34	108/110	COD. 152	464	COD. 504	462
CHIT15	295	COD. 153	464	COD. 510	435
CHIT22	295	COD. 155 / COD. 204	467	COD. 603	433
CHIT30	295	COD. 159	465	COD. 604	318
CHITBA24	294	COD. 160	463	COD. 605	318
CHITBAD24	295	COD. 161	463	COD30400	441
CHITMINI	294	COD. 162	463	COD30408	441
CHITMINI15	294	COD. 163	463	COD32100	438
CHITMINI30	294	COD. 180	464	COD32108	438
CHITMINID22	295	COD. 183	464	COD33201	433
CHITMINID30	295	COD. 184	465	COD33301	433
CHITP	295	COD. 185	465	COD33401	433
CHITRIC 10	295	COD. 188	464	COD33501	434
CHITRIC 6/D	293	COD. 190	464	COD33608	441
CHITRIC 8	296	COD. 192	465	COD33701	437
CHITRIC 9	296	COD. 300	439	COD33906	437
CHOCOBIGEV	184	COD. 301	439	COD34001	437
CHOCOBIGRING	184	COD. 303	441	COD35101	435
CHOCOBIGRING06	184	COD. 304	441	COD512	461
CHOCOFONT	185	COD. 305	435	COD513	460

Cod.	Pag
COD514	461
COD60501	433
COLONNA	468
COLONNINA	468
COVER 3	305
COVER 3H4	305
COVER 3H45	305
COVER 4	305
COVER 8	305
COVER3H48	305
CS3	359
CSL	359
CSM040	297
CSM04001 / 04009	297
CSM0402	296
CSM060	297
CSM06001 / 06009	297
CSM0602	296
CSMSPB40	357
CSMSPB60	357
CUT --	360/361
CUTTER 1 / 15	372
CUTTER 5/A	372
DC32500	275
DC32501	275
DC32504	275
DC32508	275
DECOAIR 2 / 6	390
DECOCP02	391
DECOF01	391
DECOH01	391
DECOMP 7	390
DECOMP9	390
DECOR 30	359
DRIP	247

Cod.	Pag
ED 1 / ED 9	229
EEX 1	232
EFSD001	383
EFSD002	383
EFSP017	383
EFSP019	383
EL101 / EL306	89
EM 01	231
EM 1 / EM 16	231
ESPICE14	262
ESPO ST	337
ESPO20GU001	87
ESPOB60	337
ESPOBO32	337
ESPOP30	337
ESPOP40	337
ESPOP55	337
ET003	61
ET004	61
ET004B	61
EUROCHOCK	416
EXTRA C	232
FLACONE	364
FLACONE2	364
FLAN1	364
FLEX 025 CM / 070 CM	326
FONTANINA	468
GD 01 / GD 22	395
GIRA / GIRA7	302
GL 1 / GL 3	374
GL 7 / GL 9	381
GL10 / GL11	374
GL18PRE	374
GL25PRE	374

Cod.	Pag
GS01 / GS22	395
GST01	263
GST10	263
GSTESPOB	263
GSTESPOBM40	263
GTB01 / GTB19	362/363
INOX 3	397
KITMS1	393
KITMS2	393
KITMS3	393
KITMS4	393
LAMP01	380
LAMPLEX	381
LCA000 / LCA219	409
LCA007N	409
LCA008N	409
LCA300	408
LCA304	408
LCA307	408
LCA408	408
LCA417	408
LCA419	408
LCB200 / LCB226	411
LCB204N	411
LCG000 / LCG026	405
LCJ000	417
LCJ100	417
LCP003 / LCP119	403
LCP017N / LCP019N	403
LCP202 / LCP226	404
LCP209N	404
LCP300 / LCP326	402
LCP307N / LCP309N	402
LCP508 / LCP523	407
LCS001 / LCS009	412

Cod.	Pag	Cod.	Pag	Cod.	Pag
LCS201	416	MA1040	67	MA1914	55
LCS215 / LCS220	412	MA1041 / MA1043	24/25	MA1915	55
LCS217N / LCS219N	412	MA1044	21	MA1916 / MA1917	72
LCV000 / LCV003	401	MA1045	21	MA1918	84
LCV005N / LCV015N	401	MA1046	14	MA1919	75
LCV100	416	MA1064	14	MA1920 / MA1922	35
LCV107 / LCV224	401	MA1074	15	MA1923	39
MA1002	14	MA1082	15	MA1924 / MA1925	37
MA1003 / MA1006	85	MA1091	15	MA1926 / MA1927	36
MA1007 / MA1010	31	MA1094	15	MA1951 / MA1954	111
MA1011	21	MA1281	15	MA1958 / MA1972	18/19
MA1012	21	MA1293	15	MA1974 / MA1975	134
MA1013	23	MA1303	15	MA1980 / MA1983	18
MA1014	23	MA1335	15	MA1984	134
MA1015	23	MA1350	15	MA1985 / MA1989	18/19
MA1016	23	MA1513	19	MA1990	134
MA1017	173	MA1521	15	MA1991	133
MA1018	38	MA1526	19	MA1992	172
MA1019	14	MA1527	15	MA1993 / MA1994	41
MA1020	84	MA1529	15	MA1995 / MA1996	168
MA1021	27	MA1530	15	MA1997 / MA1999	35
MA1022	27	MA1604	15	MA2000 / MA2001	57
MA1023	27	MA1606	15	MA2002	73
MA1024	27	MA1607 / MA1612	16	MA2003	19
MA1025	14	MA1613	19	MA2004 / MA2005	57
MA1026	103	MA1616 / MA1622	16	MA2006 / MA2007	73
MA1027	103	MA1624 / MA1627	16	MA2008 / MA2009	55
MA1028	103	MA1629 / MA1640	17	MA2010	57
MA1029	14	MA1800 / MA1804	17	MA2011	75
MA1030	103	MA1805 / MA1806	72	MA2012	39
MA1032	14	MA1807	57	MA2013	45
MA1033 / MA1036	77	MA1900	17	MA2014	45
MA1037	14	MA1901	18	MA2015	44
MA1038	69	MA1903 / MA1907	18	MA2016	53
MA1039	68	MA1910 / MA1913	72	MA2017	52

Cod.	Pag	Cod.	Pag	Cod.	Pag
MA2019	44	MAC281S	143	MAC800S / MAC801S	159
MA2020	50	MAC300S	143	MAC822S / MAC823S	159
MA2021	51	MAC310S	143	MAC870S	159
MA2022	44	MAC320S	143	MAC880S	159
MA2023 / MA2024	48	MAC321S	143	MAC950S	160
MA2025 / MA2026	49	MAC322S	115	MAC952S	160
MA2027 / MA2029	43	MAC323S	115	MACLO1	176
MA3005	107	MAC324S	172	MASK 5	393
MA3006	111	MAC325S	172	MASK M3 / MASK M7	393
MA3007	39	MAC326S	117	MASK R10	393
MA3008	125	MAC330	117	MASK R16	393
MA3009	124	MAC405S	172	MC000305	182
MA3010	127	MAC406S	172	MC001001	183
MA3011	126	MAC407S	139	MC09G	182
MA3012	123	MAC408S	138	MC09N	182
MA3013	122	MAC409S	138	MC09R	182
MA4005 / MA4007	33	MAC410S	143	MC10 / 108	183
MA4010 / MA4012	29	MAC411S	139	MCD101 / 104	179
MA5000 / MA5010	83	MAC412S	139	MCDA103	178
MA6001	55	MAC413S	139	MD 2	391
MA6002	55	MAC421S	143	MEL 250 / MEL 450	339
MA6003 / MA6004	73	MAC602S	158	METAL 3 / METAL 9	466
MA6005	84	MAC603S	158	MEX 250 / MEX 500	341
MA6006	75	MAC604S	158	MFRU 25 / MFRU 50	343
MA6100	71	MAC610S	159	MICROMAT30	367
MA6101	71	MAC611S	156	MICROMAT60	367
MA6102	71	MAC612S	156	MIGNON A001 / A009	229
MA6103	71	MAC613S	156	MIGNON B001 / B009	229
MA7000	63	MAC614S	156	MIGNON C001 / C009	229
MA7001	64	MAC615S	157	MIP	469
MA7002	65	MAC616S	157	MIR01 / MIR17	469
MAC000S	143	MAC620S	159	MIS02 / MIS08	469
MAC001S	143	MAC630S	159	MONOP. --	231
MAC140S	143	MAC661S	159	MRTE	381
MAC170S	143	MAC720S	159	MSC001/004	178

Cod.	Pag
MSC201/203	178
MSP 250 / MSP 350	341
MTE	381
NSA H 25 / H 60	233
NSA25X150	233
NSA27X27MO	233
NSA300X300	233
NSA30X240	233
NSA39X39MO	233
NSA400X600	233
NSA40X240	233
NSA60X40MO	233
ONE06/22	205
PALL 1/3	308
PC55 / 100	353
PD 1/2	396
PD 3/4	396
PD 5/6	396
PD 7/8	396
PD11/12	397
PD13/14	396
PDM 1/2	396
PDM 3/4	396
PDM 9/10	396
PDS1/2	396
PDS3/4	396
PINZA / PINZAX4	350
PL00100 / PL00302	429
PMFORK	394
PMKNIFE	394
PMO07.00	426
PMO07/C	426
PMO08.00	426
PMO09.00 / 14.00	430/431
PMOCE001 / 003	423

Cod.	Pag
PMOCL001	427
PMOCL001C	427
PMOCO001 / 015	421/426
PMOCU001 / 004	422
PMOCU002/C	422
PMOCU003/C	422
PMOJA001 / 002	424
PMOLO001	425
PMOLO001/C	425
PMOPE001	421
PMOTO001 / 005	425
PMOTO005/C	427
PMOVA001.00 / PMOVA003.00	431
PMSPOON	394
POMP	381
PORTFLACONE	364
PPT 12	359
PPT 12/16	359
PPT 12/18	359
PPT 14/16	359
PPT 14/18	359
PPT 8/12	359
PPT10X	359
PPT12X	359
PPT14X	359
PPT16X	359
PPT18X	359
PPT8X	359
PR30	351
PR30X30	351
PR40	351
PR40X60	351
PR50X50	351
PRA 9	361

Cod.	Pag
RAS 3	346
RC110	346
RC115	346
RD105 / RD175	346
RDC180X200	354
RELIEF 1 / 12	397
RETH4	224
RETH5	224
RETSPECIAL 1 / 2	225
RFP 12	353
RFP 6	353
RFP12INOX	353
RIGA64	365
RL 1 / 4	355
RLS 30	355
RLS 35 / 60	355
RLS50PE	355
RLS60PE	355
RLS70PE	355
RLT 15	355
ROLL H 30 / H 65	324
ROLLH3020STD	324
ROLLH4020STD	324
ROLLH5520STD	324
ROTAPINOX 5 O	352
ROTAPINOX 5 P	352
ROTAPINOX 7 O	352
ROTAPINOX 7 P	352
ROTINOX 5 P/O	352
ROTINOX 7 P/O	352
RPL 12	353
RPL 6	353
RPL12INOX	353
RPS 6	353
RSC180X140	354

Cod.	Pag	Cod.	Pag	Cod.	Pag
RSC180X200	354	SPR050/C	327	VASSOIOBMI	305
RSC70X100	354	SPZ INOX	373	VASSOIOBMO	305
RSC96X153	354	SPZ PL1	373	VASSOIOCM1	305
RSC97X210	354	SPZ PL3	373	VASSOIOCMO	305
RTC180X200	354	SPZ SE	373	VB00102 / VB00804	316/317
RTRA1-5	271	ST 1 / ST 4	237	VB00900	315
SAC45X100	327	STD 025 CM / 075 CM	326	VB00904	315
SAC58X100	327	STPK	370	VB00908	315
SBIKIT01	262	STPTA 1 / STPTA 8	370	VC30X40	305
SCM 30 / SCM 40	340	STPZ	370	VC60X40	305
SCSP01	394	SUT25X17	165	VC60X404	305
SCSP03	394	SUT28X18	165	VC60X408	305
SCSP04	394	SUT34X25	165	VP00101	318
SEG001N / SEG027N	375	SUT40X27	165	VP00206	319
SES 100 / SES 1500	369	SUT45X32	165	VP00301	319
SET DISK	377	SUT54X36	165	VP00401	318
SETAC 16 / SETAC 30	351	SUT64X43	165	VP00500	319
SETACIOK	351	SUT75X50	165	VP00501	318
SETACIOK2	351	TAG 5	365	VP00601	319
SF001 / SF502	244	TAV --	377	VP00700	318
SF001/N / SF502/N	244	TEFLONPAT	367	VP00801	318
SFT 118/Y / 1205/Y	248	TFL 10	397	VP00906	319
SG 01 / SG 09	249	TFL 15	397	VP01001	319
SGM00 / SGM100	269	TFRU 25 / 50	343	VP01106	319
SILICOPAT1/B / 4/B	367	TL 03 / TL 15	299	VP01201	319
SILICOPAT1/R / 7/R	367	TPB1	232	ZENBO00 / ZENBO02	428
SM 1000 / SM 4000	163	TPEX 1	232	ZENBO00C	428
SMA110 / SMA320	363	TPG 01	231	ZENTRO0 / ZENTRO2	428
SPB SPECIAL	357	TPG 1 / TPG 13	231		
SPINNER	301	TPG16	232		
SPR034	327	TPIDEA01 / 03	235		
SPR034/C	327	TPM 1 / TPM 9	229		
SPR045	327	TS1	302		
SPR045/C	327	VASSOIOAMI	305		
SPR050	327	VASSOIOAMO	305		

Martellato srl, ai sensi della Legislazione Comunitaria vigente:

Regolamento CE n. 1935/2004
Materiali e oggetti destinati a venire a contatto con i prodotti alimentari.

Regolamento UE n. 10/2011 e smi
Riguardante i materiali e gli oggetti di materia plastica
destinati a venire a contatto con i prodotti alimentari.

Regolamento CE n. 2023/2006
Buone pratiche di fabbricazione (GMP) dei materiali e degli oggetti
destinati a venire a contatto con i prodotti alimentari.

E alla seguente Legislazione Nazionale vigente:

D.M. Italiano 21/03/1973 e successive modifiche
Disciplina igienica degli imballaggi, recipienti, utensili, destinati a venire a contatto
con le sostanze alimentari o con sostanze d'uso personale.

D.P.R. 777/82 e successivi aggiornamenti e modifiche

**Ha emesso uno specifico Capitolato che obbliga i suoi fornitori al rispetto
di determinate precauzioni igieniche durante la fabbricazione,
lavorazione e imballo degli articoli Monouso elencati nel presente catalogo.
Per tutti gli altri articoli la Martellato srl richiede all'utilizzatore la precauzione
di lavarli accuratamente con acqua e detergente neutro prima dell'uso.**

Martellato srl, accordingly to EC laws:

EC Regulation no. 1935/2004
Materials and articles intended to come into contact with food.

EU Regulation no. 10/2011 and smi
Regarding the materials and plastic articles intended to come into contact with food.

EC Regulation no. 2023/2006
Good Manufacturing Practices (GMP) of materials and articles intended to come into contact with food.

And to the following National Legislation in force:

Italian Ministerial Decree 21/03/1973 and subsequent updates and changes
Hygiene regulation for packaging, containers, utensils, intended to come into contact with food
or with substances for personal use.

Presidential Decree 777/82 and subsequent updates and changes

**Issued a specification that requires its suppliers to comply with certain hygienic precautions
during manufacture, processing and packaging of the disposable items listed in this catalogue.
For all other items Martellato srl asks users to wash thoroughly
with water and mild detergent before use, as a precaution.**

MARTELLATO si riserva la facoltà di modificare in qualsiasi momento e senza preavviso
le caratteristiche tecniche degli articoli presentati in questo catalogo.
È vietata la riproduzione, anche parziale, di questo catalogo senza l'autorizzazione di MARTELLATO

MARTELLATO reserves the right to modify at any time without notice the technical specifications of the items in this catalogue.
Any reproduction, even partial, of this catalogue without permission is strictly prohibited.

