

CAMBRO®

Catalog 2025 U.S.A.

TRUSTED DURABILITY

www.cambro.com

TABLE of CONTENTS

EQUIPMENT



INSULATED TRANSPORT 9

- Cambro® GoBags® 9
- Cam GoBoxes® 17
- The Pro Cart Ultra® 23
- Insulated Food Server (Electric) 26
- Insulated Food Server Front Loader (Non-Electric) 36
- Top-Loading Carriers 43
- Transporter Capacity Guide 45
- Temperature Maintenance 46
- Camdollies® & Accessories 48
- Insulated Beverage Servers 50
- Beverage Service Cart 53
- Handwashing Stations 55

PERSONALIZATION

- GoBags 15



MERCHANDISING 57

- CVC75 Mobile Food Vending Cart 57
- CamKiosk® System 60
- Hand Sink Cart / Work Station / Equipment Stand 62
- Camcruiser® Vending Carts 63
- Camshelving® Flex Station System 65
- Versa Food Bar System 68
- Food Bar Accessories 71
- Table Top Food Bars 72
- Versa Organizers 73
- Portable CamBars® 74
- Ice Caddies 81

PERSONALIZATION

- CVC75 59
- CamKiosks® 61
- Camcruisers® 63



WAREWASHING 82

- Camrack® 4-in-1 System 82
- Stemware and Glass Reference Guide 88
- Cup Rack & Reference Guide 89
- Camdollies® & Utility Trucks 98
- S-Series Adjustable Dish Caddies 100
- Dish Caddies 101
- Tray & Dish/Silver Cart 103
- KD Service Cart & KD Utility Cart 105
- Service Carts Pro 106
- Cambox® Bus Boxes 108

PERSONALIZATION

- Camracks 95



CAMSHELVING® 109

- Key Features 110
- Buyers Guide 112
- Free Design Service 113
- Overall Length — Quick Reference Guide 114
- Camshelving Premium® Series 116
- Premium Series Weight Bearing Chart 117
- Premium Series Configurations and Accessories 119
- Premium Series High Density Storage System 122
- Camshelving Elements® XTRA Series 126
- Elements XTRA Series Weight Bearing Chart 127
- Elements XTRA Series Configurations and Accessories 129
- Elements XTRA Series High Density Storage System 132
- Camshelving Basics® Plus Series 134
- Basics Plus Series Weight Bearing Chart 135
- Basics Plus Series Configurations and Accessories 137



SHELVING UTILITY 141

- Camshelving Accessories 141
- Drying and Storage Rack 144
- Elements Series 2-Shelf Vented Undercounter Units 145
- Wine Rack 146
- Pegboard Storage System 148
- Camshelving Universal Storage Rack 149
- Camshelving Ultimate #10 Can Rack System 150
- The Ultimate Sheet Pan Rack 152
- GN Food Pan Trolley 154
- Pan Stops 156
- Full Size Covers 156
- Elevation Series Wall Shelving 157
- Dunnage Racks 164
- Camlink® 164

In Stock Now

Products highlighted in grey are Cambro's top-selling and most frequently ordered products. These products are available to ship to Certified Cambro Distributors with their next shipment. Broken cartons are excluded.

SUPPLIES



STORAGE 165

- Food Storage Square Containers 166
- Food Storage Round Containers 177
- Food Storage Boxes & Lids 181
- StoreSafe® Labels 185
- Camwear® Food Pans & Lids 187
- H-Pans™ High Heat Pans 191
- High Heat H-Pan™ with Handle(s) 195
- Translucent Food Pans 196
- ColdFest® 199
- Pizza Dough Boxes 200
- Ingredient Bins & Scoops 201
- Soak and Brine Tank & Camcrisper® 202
- High Heat Measuring Cups & Camwear® Measuring Cups 203
- Allergen Management 204

PERSONALIZATION

- CamSquare® 176
- Food Pans 217



TABLE SERVICE 205

- Lido® and Camwear® Tumblers 206
- Huntington® and Newport Tumblers 207
- Laguna® and Del Mar® Tumblers 208
- Colorware Tumblers and Dessert Glass 209
- Camliter® 210
- Pitchers 211
- Dinnerware 212
- Camcovers® 214
- Beverage Dispenser, Pail With Bail & Swirl Bowls® 215
- Wine Buckets and Bud Vase 216

PERSONALIZATION

- Dessert Glass, Tumblers, Camliters, Pitchers, and Wine Buckets 217



DISPLAY 218

- Deli Crocks & Platter 218
- Camwear® Bowls 219
- Budget & Fiberglass Bowls 221
- Crocks & Ladles 222
- Serving Spoons, Camtensils® & Turners 223
- Lugano® Tongs 224
- Shakers/Dredges & Condiment Jars 225
- Display Covers & Trays 226

PERSONALIZATION

- Shakers 225



TRAYS 227

- Trays At A Glance 227
- Camtrays® 230
- Camtrays with Handles 232
- Décor Series Camtrays 235
- Non-Skid Versa Camtrays 236
- Camwear® Trays 237
- Hotel Room Service Trays 238
- Camtread® Trays 239
- Treadlite™ & Polytread® Trays 240
- Fast Food Trays 242
- Market Trays, Pans & Camlite® Trays 243
- Compartment Trays 244

PERSONALIZATION

- Camtray 229
- Camtread Trays 241
- Fast Food Trays 242

HEALTHCARE



HEALTHCARE 249

- Non-Skid Versa Camtrays® 250
- Camwear® Trays & Non-Skid Trays 251
- Décor Series Epitread™ Camtrays 251
- Meal Delivery Ware System 252
- Temperature Retention Systems 254
- Tumbler, Swirl Bowl & Disposable Camlids® 256
- Camduction® Complete Heat System 257
- Reusable CamLids® & Camrack® Wash and Store Rack 258
- Air Curtain Ultra™ 259
- Meal Delivery Carts 260
- Airpot & Condiment Station 261
- Camshelving® Hygienic Drying Racks 266
- Roto Color Chart 268

New Product Introduction

The Pro Cart Ultra Pan Carriers



Camshelving® Universal Storage Rack



Cambro Mobile Food Vending Cart

Mobile Handwash Station



Camshelving® Elements® XTRA Series

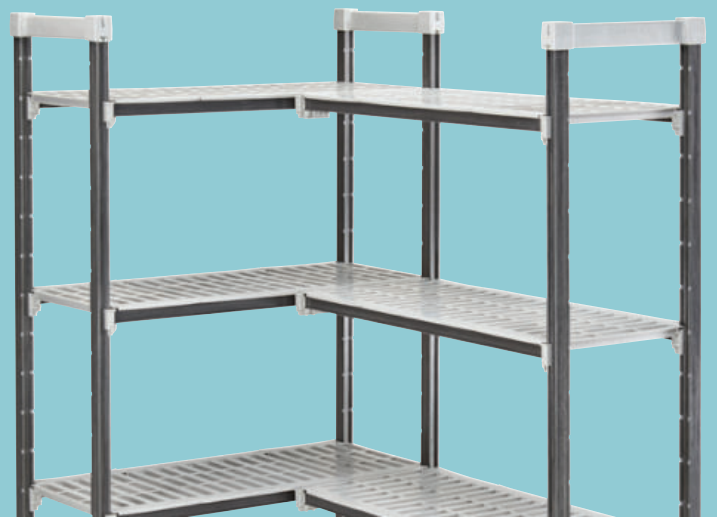

**Camshelving GN
Food Pan Trolleys**



**Camshelving®
Wine Rack**



Elevation Series Wall Shelving

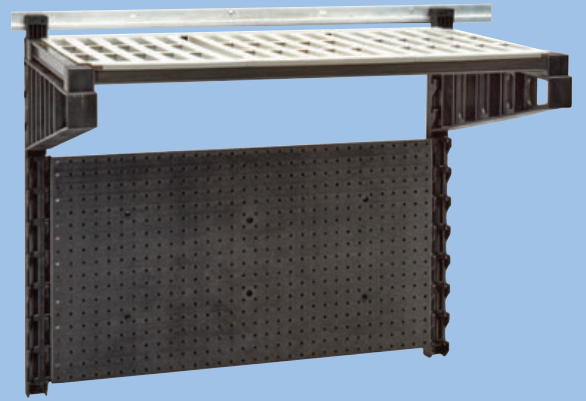

**Camshelving Ultimate
Sheet Pan Rack**



**CamSquares®
FreshPro**

**Translucent
CamSquares®
16oz. and 32oz.**



**Camliters®
with Flip Lid**



Meal Delivery Carts



Service Cart Pro





the Cambro[®] story

When William and Argyle Campbell first opened the doors at Cambro Manufacturing in 1951, their goal was to make the highest quality hospital meal tray possible. Named the Camtray, it demonstrated that they were as committed to excellence in the foodservice industry as they were with their own products. As 2025, marked the company's 74th year of leadership in quality, innovation and customer service, today Cambro serves the world with the industry's most complete selection of products for widely diverse segments of the foodservice business. The future is certain to bring great changes to our industry. Yet one thing that will remain a constant is Cambro's tradition of continually developing new products that help foodservice operators save time and money, increase sales, reduce labor and improve service. In the years ahead, guided by the commitment of its founders to innovation, quality, and value, Cambro Manufacturing will still be the leader in serving the foodservice industry and you, our valued customer.

ICON DIRECTORY

Throughout the Cambro catalog, please use the following easy-to-identify icons to help explain Cambro product features or services.



Food Safety Matters

For 70 years, Cambro foodservice equipment and supplies have earned the trust and loyalty of customers and public health professionals alike because our products are designed with Food Safety in mind. At Cambro, every product design is based upon the core principle of food safety.

Look for the Cambro StoreSafe mark throughout the Cambro catalog to identify Cambro storage and transportation products that support safe food handling.

You can learn more about Cambro's Food Safety initiatives at www.cambro.com/storesafe



Many Cambro products may be recycled. For further information, please contact your Cambro representative.



Listed by NSF International, an independent, not-for-profit organization which certifies products that meet their criteria for sanitation and cleanability.



CA PROP 65

WARNING: This product can expose you to chemicals including Bisphenol A (BPA), which is known to the State of California to cause birth defects or other reproductive harm. For more information, go to www.P65Warnings.ca.gov. Warning applies to State of California only.



New Product



Dishwasher Safe



Stackable



Foam Insulation



Pro-Rated Warranty



Not For Use In Heated Carts



Personalization Available Non-Food Contact Areas Only.



One carton of product is within the weight and cube requirements to be shipped by parcel carrier.

www.cambro.com

Visit www.cambro.com for a wide variety of information about our products, including new product updates, an interactive Camrack Glass to Rack Guide, consultant cut sheets and CAD drawings, care and maintenance product guides and more.

CAMBRO® GENERAL TERMS AND WARRANTY

General Terms

Cambro products may be combined to obtain prepaid freight.

Specifications, features and equipment shown are based upon the latest information available. Cambro Manufacturing Company reserves the right to make changes at any time, without notice, to price, colors, specifications, accessories and materials. For additional information, please contact your authorized Cambro representative.

Freight

Freight is free on shipments totaling **\$3,900** net or more, based on a single order for single delivery **within the continental U.S.A. (48 Contiguous United States)**. Orders for shipments totaling less than **\$3,900** are F.O.B. Any items back ordered from a "free freight order" will be forwarded transportation charges paid. Add-ons are not allowed on "free freight order backorders".

Return Merchandise Policy

No merchandise may be returned without written authorization. Authorized returns must be shipped freight prepaid. All returned goods must be new and unused, in full case quantities and original packaging, they are subject to a minimum 15% repackaging charge plus outbound freight. Return of goods must be requested within 60 days of invoice. Special or non-standard items are not returnable. Electrical components returned are subject to inspection prior to credit being issued.

Assessorial Charges

From time to time, motor carriers will charge for services that are beyond the scope of a normal delivery. In the event that this happens, Cambro Mfg. reserves the right to bill the customer for these charges. Services that fall under this program would include:

- Sort & Segregation of product at customer's dock.
- Lift-gate required to off load the product from the truck.
- Inside delivery requests.

These charges are considered to be assessorial charges and are not included in the prepaid freight program.

Broken Cartons

Orders calling for less than standard pack will be charged \$10.00 net per broken case. Broken cartons are not available on any special order items, the assortment pack, custom imprinted ladles, 4 pack booster chairs, disposable lids or on StoreSafe labels. **There is no broken carton charge on Camracks.**

Replacement Parts

Visit www.cambro.com for replacement parts information on Cambro products.

Product Accessories

Contents and accessories shown in photos are not included, except where noted.

Cambro® Warranty

Cambro offers a 5-year pro-rated warranty against damage or manufacturer's defects found in excess to normal wear and tear on our Camtrays®, Camtread® trays and Dinnerware. Commercial Electrical Equipment models hold a 1-year warranty. Non-Skid Versa Camtrays, Tongs, Camwear® Food Storage Pans, all high heat material products, Squares, Rounds and Lids have a 2-year pro-rated warranty. All Camshelving® Series have a 1-year warranty on workmanship and a lifetime limited warranty against rust and corrosion, excluding mobile posts. For all other Cambro products, Cambro warrants to the original buyer a 3-year pro-rated warranty unless otherwise noted. If product proves defective during this time, Cambro grants a pro-rated credit of the original price toward replacement product. The warranty applies on all Cambro products only when used under normal foodservice industry conditions.

Note: Temperature ranges noted throughout this catalog are based on specific test criteria and provide a general guideline. Individual use may vary due to differences in loading temperatures or ambient temperature.

The Trademarks of Cambro and product images are the property of Cambro and are subject to the control and ownership of Cambro. Any use thereof is only granted for the promotion and sales of Cambro products and subject to the control of Cambro Manufacturing Company.

DO IT ALL WITH

CAMBRO[®] GOBAGS[®]



From the time the food is prepped to the moment it reaches the customer's doorstep, every second counts. Speed is important, but keeping the food fresh and out of the danger zone is imperative to every successful delivery, take-out and curbside pick-up operation. Cambro GoBags' high-density insulation keeps temperature in the safe zone during both holding and transport to the customer, whether it's picked up curbside or delivered to their door.

CAMBRO® PIZZA DELIVERY GOBAGS®

Guarantee a hot, crispy pizza delivery with a Pizza GoBag, protected by dense, high-quality insulation. With a Cambro Pizza Bag you can change your delivery game, with bag personalization available to maximize the value.

- 🍕 Standard Pizza GoBags are constructed with 600-denier polyester fabric
- 🍕 Premium Pizza GoBags are constructed with 900-denier nylon fabric, Made in USA



HOT AND FRESH PIZZA

**BREATHABLE MATERIAL
NO SOGGY PIZZA**

DURABLE AND EASY TO CLEAN



CAMBRO® GOBAGS® – PIZZA BAGS



- Thick, sturdy nylon fabric.**
- Breathable nylon material protects food quality.**
- High-density insulation keeps food hot.**
- Heavy-duty, sewn-in straps and ticket pouch.**

**Find the Perfect
Pizza GoBag!**

[Click here](#)

Standard Pizza Bags



GBP216

Carries two 16" or three 14" pizza boxes

L 18" x W 18" x H 6½"

LIST PRICE EACH: \$ 47.85

Case Pack: 4

Colors: Black (110), Red (521).



GBP318

Carries three 18" or four 16" pizza boxes

L 20" x W 20" x H 7½"

LIST PRICE EACH: \$ 60.00

Case Pack: 4

Colors: Black (110), Red (521).



GBP220

Carries two 20" or three 18" pizza boxes

L 21¾" x W 21¾" x H 6½"

LIST PRICE EACH: \$ 77.75

Case Pack: 4

Colors: Black (110), Red (521).



GBP518

Carries five 18" or six 16" pizza boxes

L 19½" x W 19½" x H 12½"

LIST PRICE EACH: \$ 83.75

Case Pack: 4 Color: Black (110).



GBP1018

Carries ten 18" pizza boxes

L 19" x W 19" x H 23"

LIST PRICE EACH: \$ 149.75

Case Pack: 4 Color: Black (110).

Premium Pizza Bags



GBPP212

Carries two 12" pizza boxes

L 12½" x W 13¾" x H 6½"

LIST PRICE EACH: \$ 204.00

Case Pack: 1

Colors: Black (110), Red (521).



GBPP214

Carries two 14" pizza boxes

L 14½" x W 15¾" x H 7½"

LIST PRICE EACH: \$ 204.00

Case Pack: 1

Colors: Black (110), Red (521).



GBPP216

Carries two 16" or three 14" pizza boxes

L 17½" x W 17½" x H 7½"

LIST PRICE EACH: \$ 204.00

Case Pack: 1

Colors: Black (110), Red (521).



GBPP218

Carries two 18" pizza boxes

L 19¾" x W 19½" x H 8¾"

LIST PRICE EACH: \$ 204.00

Case Pack: 1

Colors: Black (110), Red (521).



GBPP318

Carries three 18" or four 16" pizza boxes

L 19" x W 20" x H 9"

LIST PRICE EACH: \$ 215.00

Case Pack: 1

Colors: Black (110), Red (521).



GBPP518

Carries five 18" pizza boxes

L 19" x W 19¾" x H 12"

LIST PRICE EACH: \$ 215.00

Case Pack: 1

Colors: Black (110), Red (521).



GBPP1018

Carries ten 18" pizza boxes

L 18½" x W 19" x H 23"

LIST PRICE EACH: \$ 215.00

Case Pack: 1

Colors: Black (110), Red (521).

CAMBRO® CATERING AND DELIVERY BAGS

GoBags® for delivery help protect the signature items your customers crave. Your recipes, your quality, and your brand are delivered to your customers safe and sound. Add a heat transfer design to your bag to promote your brand image to the customer.



CAMBRO® GOBAGS® – CATERING BAGS



- Thick, sturdy nylon fabric.
- High-density insulation keeps food hot.
- Heavy-duty, sewn-in straps and ticket pouch.

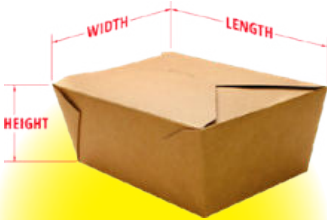

Find the best fit for your to-go containers.

[Click here](#)



GBD101011
 Small Folding Delivery Bag
 L 10" x W 10" x H 11"
 LIST PRICE EACH: \$ 72.00
 Case Pack: 4 Color: Black (110).

GBD121515
 Medium Folding Delivery Bag
 L 12" x W 15" x H 15"
 LIST PRICE EACH: \$ 101.75
 Case Pack: 4 Color: Black (110).

GBD211417
 Large Folding Delivery Bag
 L 21" x W 14" x H 17"
 LIST PRICE EACH: \$ 131.50
 Case Pack: 4 Color: Black (110).



GBD211414
 Large Delivery Bag includes vertical, thermal divider
 L 21" x W 14" x H 14"
 LIST PRICE EACH: \$ 131.50
 Case Pack: 4 Color: Black (110).

Comes with structured bottom and divider panel.



GBD13913
 Small Top Loading Delivery Bag
 L 13" x W 9" x H 13"
 LIST PRICE EACH: \$ 89.75
 Case Pack: 4
 Color: Black (110), Red (521).

GBD151212
 Sandwich Bag
 L 15" x W 12" x H 12"
 LIST PRICE EACH: \$ 95.75
 Case Pack: 4
 Color: Black (110), Red (521).

GBD181412
 Jumbo Delivery Bag
 L 18" x W 14" x H 12"
 LIST PRICE EACH: \$ 107.75
 Case Pack: 4
 Color: Black (110), Red (521).

GBD211517
 Stadium Delivery Bag
 L 21" x W 15" x H 17"
 LIST PRICE EACH: \$ 156.00
 Case Pack: 4
 Color: Black (110), Red (521).

CAMBRO® GOBAGS® ACCESSORIES AND PERSONALIZATION



Thermal Pads



GBTPSM
Thermal Pad Small
L 10" x W 14½"
LIST PRICE EACH: \$ 44.30
Case Pack: 1 Color: Black (110).

GBTPMD
Thermal Pad Medium
L 14" x W 20½"
LIST PRICE EACH: \$ 46.70
Case Pack: 1 Color: Black (110).

GBTPLG
Thermal Pad Large
L 15½" x W 21½"
LIST PRICE EACH: \$ 50.25
Case Pack: 1 Color: Black (110).

Frames and Liners



GBFSM
GoBag Frame Small
L 13" x W 10" x H 9"
LIST PRICE EACH: \$ 63.50
Case Pack: 1 Color: (000).

GBFMD
GoBag Frame Medium
L 13" x W 9" x H 13"
LIST PRICE EACH: \$ 77.75
Case Pack: 1 Color: (000).

GBFLG
GoBag Frame Large
L 18" x W 14" x H 12"
LIST PRICE EACH: \$ 117.25
Case Pack: 1 Color: (000).

GBLSM
GoBag Liner Small fits GBD13913
L 13½" x W 9½" x H 7½"
LIST PRICE EACH: \$ 117.25
Case Pack: 1 Color: Clear (CLR).

GBLMD
GoBag Liner Medium fits GBD13913
L 14" x W 9½" x H 12½"
LIST PRICE EACH: \$ 120.50
Case Pack: 1 Color: Clear (CLR).

GBLLG
GoBag Liner Large fits GBD181412
L 20½" x W 14" x H 11"
LIST PRICE EACH: \$ 130.25
Case Pack: 1 Color: Clear (CLR).



CAMBRO® GOBAGS® – BACKPACKS



- 🍔 High-density insulation maintains safe temperature and food quality.
- 🍔 Folds for compact storage.
- 🍔 Easy to clean.



GBBP111417
 Small Cambro GoBag Backpack
 L 11" x W 14" x H 17"
 LIST PRICE EACH: \$ 180.00
 Case Pack: 4 Color: Black (110).

GBBP151417
 Large Cambro GoBag Backpack
 L 15" x W 14" x H 17"
 LIST PRICE EACH: \$ 191.00
 Case Pack: 4 Color: Black (110).



PERSONALIZE YOUR GOBAG®

CUSTOMIZE YOUR GOBAG AT
apps.combro.com/customgobags

Click here

3 EASY STEPS



1. SELECT A GOBAG



2. UPLOAD YOUR DESIGN



3. VIEW & DOWNLOAD

CAM GOBOX® PROFESSIONAL GRADE INSULATED CARRIERS – TOP LOADERS

LINE YOUR CAM GOBOX

A Cambro GN Food Pan and Seal Cover or liner are recommended to keep your Cam GoBox clean and sanitary.



EASY LOADING AND UNLOADING

Interior wall recesses make loading and unloading easy for both GN 1/1 as well as 1/2 pans. Straight interior walls allow room for stacking pans inside carrier.



OPTIONAL INSERT KIT

For an additional cold boost, use with optional Camchiller Insert Kit. Built-in cut-outs support cold transfer while protecting food from condensation.

ERGONOMIC HANDLES

Comfortable handles allow easy and safe lifting of the EPP180LHSW GoBox.

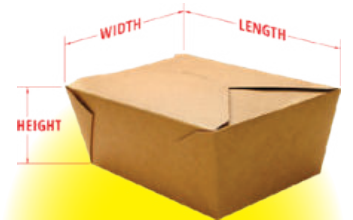

Find the best fit for your to-go containers.

[Click Here](#)



STACKABILITY

Cam GoBoxes inter-stack.

TEMPERATURE RETENTION

4+ hours



Use colored lids for quick content identification or routing.

CAM GOBOX® PROFESSIONAL GRADE INSULATED CARRIERS — FRONT LOADERS

4-SIDED HANDLING

Thoughtfully designed built-in handles along the top of front loading models allow them to be easily carried from all four sides.



DRIP-RESISTANT

Built-in condensation barrier helps front loaders to remain drip-resistant.



FULL 270° ACCESS

Durable hinges and latches allow the door to open 270° and remain open securely to the side of the front loader for easy access to products. Latches keep door securely closed during transport.



GENTLE OPEN AND CLOSE

Beveled door edges ensure door can be easily closed and latched.

STACKABILITY

Cam GoBoxes inter-stack.

LARGE CAPACITY

Cam GoBox front loading carriers are designed with enough room to hold GN 1/1 pans along with Camwarmers® or Camchillers®, if desired.

TEMPERATURE RETENTION

4+ hours



CAM GOBOX® PROFESSIONAL GRADE INSULATED CARRIERS



For Half-Size (GN1/2) Food Pans



EPP260SW

Holds 1 each 6" deep food pan*

EXTERIOR: L 15.4" x W 13" x H 10"

INTERIOR: L 13" x W 10.6" x H 7.6"

UNIT WEIGHT: 1.37 lbs.

VOLUME: 17.9 qt.

LIST PRICE EACH: \$ 62.25

Case Pack: 1 Color: Black (110).



EPP280SW

Holds 1 each 8" deep food pan*

EXTERIOR: L 15.4" x W 13" x H 12.4"

INTERIOR: L 13" x W 10.6" x H 10"

UNIT WEIGHT: 1.54 lbs.

VOLUME: 23.6 qt.

LIST PRICE EACH: \$ 69.50

Case Pack: 1 Color: Black (110).



EPP280WSTSW

Holds 1 each 8" deep food pan*

EXTERIOR: L 15.4" x W 13" x H 12.4"

INTERIOR: L 13" x W 10.6" x H 10"

UNIT WEIGHT: 1.8 lbs.

VOLUME: 23.6 qt.

LIST PRICE EACH: \$ 79.00

Case Pack: 1 Color: Black (110).



EPP160SW

Holds 1 each 6" deep food pan*

EXTERIOR: L 23.6" x W 15.7" x H 10"

INTERIOR: L 21.2" x W 13.3" x H 7.7"

UNIT WEIGHT: 2.4 lbs.

VOLUME: 37.5 qt.

LIST PRICE EACH: \$ 93.50

Case Pack: 1 Color: Black (110).



EPP180

Holds 1 each 8" deep food pan*

EXTERIOR: L 23.6" x W 15.7" x H 12.4"

INTERIOR: L 21.2" x W 13.3" x H 10"

UNIT WEIGHT: 2.6 lbs.

VOLUME: 48.6 qt.

LIST PRICE EACH: \$ 101.75

Case Pack: 1 Color: Black (110).



EPP180S

Holds 1 each 8" deep food pan*

EXTERIOR: L 23.6" x W 15.7" x H 12.4"

INTERIOR: L 21.2" x W 13.3" x H 10"

UNIT WEIGHT: 2.9 lbs.

VOLUME: 45.44 qt.

LIST PRICE EACH: \$ 101.75

Case Pack: 1 Color: Black (110).



EPP180FLSW

Holds 1 each 8" deep food pan*

EXTERIOR: L 23.6" x W 15.7" x H 12.4"

INTERIOR: L 21.2" x W 13.3" x H 10"

UNIT WEIGHT: 2.6 lbs.

VOLUME: 48.6 qt.

LIST PRICE EACH: \$ 137.75

Case Pack: 1 Color: Black (110).



EPP180LHSW

Holds 1 each 8" deep food pan*

EXTERIOR: L 26.8" x W 15.73" x H 12.6"

INTERIOR: L 21.2" x W 13.9" x H 10"

UNIT WEIGHT: 2.6 lbs.

VOLUME: 48.6 qt.

LIST PRICE EACH: \$ 137.75

Case Pack: 1 Color: Black (110).

Carriers with Colored Lids



EPP180CLSW

Holds 1 each 8" deep food pan*

EXTERIOR: L 23.6" x W 15.7" x H 12.4"

INTERIOR: L 21.2" x W 13.3" x H 10"

UNIT WEIGHT: 2.6 lbs.

VOLUME: 48.6 qt.

LIST PRICE EACH: \$ 113.00

Case Pack: 1 Carrier Color: Black (110). Lid Colors: Red (365), Blue (362).



EPP180XLTSW

Holds 1 each 8" deep food pan*

EXTERIOR: L 24" x W 17" x H 15.4"

INTERIOR: L 21.6" x W 14.5" x H 12.6"

UNIT WEIGHT: 3.2 lbs.

VOLUME: 68.2 qt.

LIST PRICE EACH: \$ 119.50

Case Pack: 1 Color: Black (110).



EPP300

Holds 3 each 4" deep food pans*

EXTERIOR: L 25.2" x W 17.3" x H 18.7"

INTERIOR: L 21" x W 13" x H 14.6"

UNIT WEIGHT: 7 lbs.

VOLUME: 63.4 qt.

LIST PRICE EACH: \$ 350.00

Case Pack: 1 Color: Black (110).



EPP400

Holds 4 each 4" deep food pans*

EXTERIOR: L 25.2" x W 17.3" x H 24.6"

INTERIOR: L 21" x W 13" x H 20.7"

UNIT WEIGHT: 8.6 lbs.

VOLUME: 90.9 qt.

LIST PRICE EACH: \$ 398.00

Case Pack: 1 Color: Black (110).

*Or equivalent

CAM GOBOX® PROFESSIONAL GRADE INSULATED CARRIERS

For Meal Trays

Ideal for:

- Relief Agencies.
- Central Kitchens.
- Summer or After School Meal Programs.

MAINTAINS HOT OR COLD TEMPERATURES FOR

4 hours

Use hot or cold packs to extend holding time beyond 4 hours.



EPPMTSW

Holds meal trays

EXTERIOR: L 20.5" x W 16.2" x H 12.6"

INTERIOR: L 18" x W 13.8" x H 10"

LIST PRICE EACH: \$ 89.75

Case Pack: 1 Color: Black (110).

Tray Sizes and Capacity

TOTAL TRAY CAPACITY
24



Tray Size:

6½" x 8½" x 1½"
4 tiers of 6 trays.



TOTAL TRAY CAPACITY
16

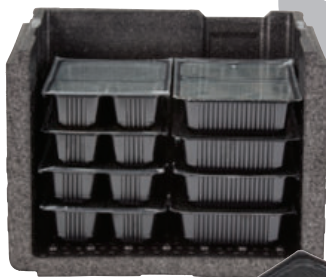

Tray Size:

6½" x 8½" x 2"
4 tiers of 4 trays.



MIX & MATCH TRAY SIZES



2 tiers of 6 trays – 6½" x 8½" x 1½"

2 tiers of 4 trays – 6½" x 8½" x 2"

For Milk Crates

- Holds a 13" x 13" x 11" (33 x 33 x 28 cm) milk crate with up to 70 half pints of milk.
- Easy to clean and dishwasher safe.
- 100% recyclable.
- Made from durable CFC-free expanded polypropylene.
- Features a convenient, adjustable web strap.

TEMPERATURE RETENTION

4+ hours



NSF

EPPMBWSTW

Holds 1 each 13" x 13" x 11" milk crate

EXTERIOR: L 16.1" x W 16.1" x H 16"

INTERIOR: L 13.8" x W 13.8" x H 13"

UNIT WEIGHT: 2.7 lbs.

VOLUME: 42.8 qt

LIST PRICE EACH: \$ 95.75

Case Pack: 1 Color: Black (110).



CAM GOBOX® PROFESSIONAL GRADE INSULATED CARRIERS

Beverage Holder

Modular beverage holder for transporting hot or cold drinks with ease. Interlocking units connect to hold up to 15 drinks in an EPP180. Holds 8 to 32 oz. hot or cold cups.



Compartments are tapered to fit multiple cup sizes: 2.8" at bottom graduates to 3.5" at the top.



CODE	DESCRIPTION	DRINK CAPACITY	LIST PRICE EA.
EPPBEVH2	set of 2 holders	6	15.55
EPPBEVH5	set of 5 holders	15	38.90

Exterior Dim.: L 4.5" x W 12.8" x H 4.9"
Case Pack: 1 Color: Black (110).

GOBOX CODE	NUMBER OF DRINKS	NUMBER OF HOLDERS
EPP180	15 (single layer*)	5 (single)
	30 (double layer**)	10 (double)
EPP160	15	5
EPP280	6 (single)	2 (single)
EPP260	6	2

*Single layer only recommended for hot cups. Use with Beverage Plugs to prevent spilling during transport.

**Double layer possible only with 12 oz. or smaller cups.

Camdollies®

CDC300

Fits EPP400, EPP300, EPP180SW, EPP160SW, UPC300, 1318CC

EXTERIOR: L 24.9" x W 17.3" x H 7.3"

INTERIOR: L 24.5" x W 17"

UNIT WEIGHT: 11.65 lbs.

LOAD CAPACITY: 300 lbs.

LIST PRICE EACH: \$ 238.00

Case Pack: 1 Color: Red (358).



CDC400

Fits EPP180XLTSW, EPP400

EXTERIOR: L 25.3" x W 18.5" x H 6.9"

INTERIOR: L 24.5" x W 18.1"

UNIT WEIGHT: 11.7 lbs.

LOAD CAPACITY: 300 lbs.

LIST PRICE EACH: \$ 270.00

Case Pack: 1 Color: Red (358).



CDC400

CDC300

CAM GOBOX® ACCESSORIES

Camchillers®, Camwarmer® and ThermoBarrier®



CP3253
 Camchiller GN 1/1 for EPP160SW, EPP180SW, EPP180LHSW, EPP300, EPP400
L 20.9" x W 12.8" x H 1.2"
UNIT WEIGHT: 8.6 lbs.
LIST PRICE EACH: \$ 107.75
Case Pack: 1 **Color:** Glacier Blue (443).



CP2632
 Camchiller GN 1/2 for EPP260SW, EPP280SW, EPP280WSTSW
L 12.8" x W 10.4" x H 1.2"
UNIT WEIGHT: 3.9 lbs.
LIST PRICE EACH: \$ 89.75
Case Pack: 1 **Color:** Glacier Blue (443).



HP2632
 Camwarmer GN 1/2 for EPP260SW, EPP280SW, EPP280WSTSW
L 12.8" x W 10.4" x H 1.2"
UNIT WEIGHT: 3.8 lbs.
LIST PRICE EACH: \$ 78.00
Case Pack: 1 **Color:** Fire Red (444).



EPP3253DIV
 ThermoBarrier for EPP300 & EPP400
L 20.9" x W 12.9" x H 1.5"
UNIT WEIGHT: 0.8 lbs.
LIST PRICE EACH: \$ 33.50
Case Pack: 1 **Color:** Black (110).

Camchillers Inserts and Kits

Built-in cutouts support cold transfer while protecting food below from condensation.



EPPCTS
 Camchiller Insert for Standard EPP180SW & EPP160SW
EXTERIOR: L 23.6" x W 15.7" x H 3.4"
INTERIOR: L 21.1" x W 13.3" x H 1.3"
UNIT WEIGHT: 0.8 lbs.
LIST PRICE EACH: \$ 62.25
Case Pack: 1 **Color:** Black (110).



EPPCTL
 Camchiller Insert for EPP180LHSW
EXTERIOR: L 23.8" x W 15.7" x H 3.4"
INTERIOR: L 21.1" x W 13.3" x H 1.3"
UNIT WEIGHT: 0.8 lbs.
LIST PRICE EACH: \$ 66.00
Case Pack: 1 **Color:** Black (110).



EPPCTSPKG
 Camchiller and Insert all in one package, available for EPP180SW and EPP160SW
L 23.6" x W 15.7" x H 3.4"
UNIT WEIGHT: 9.4 lbs.
LIST PRICE EACH: \$ 172.00
Case Pack: 1 **Color:** Black (110).

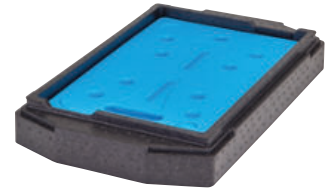

EPPCTLPKG
 Camchiller and Large Handle Insert all in one package, available for EPP180LHSW
L 23.6" x W 15.7" x H 3.4"
UNIT WEIGHT: 9.4 lbs.
LIST PRICE EACH: \$ 192.00
Case Pack: 1 **Color:** Black (110).

Cam GoBox Extender

Add 4" to your top loader GoBox to fit oversized items.



EPPEXT
 4" extender fits EPP180SW, EPP160SW and EPP140SW
EXTERIOR: L 23.6" x W 15.7" x H 3.9"
INTERIOR: L 21.1" x W 13.3"
UNIT WEIGHT: 0.52 lbs.
LIST PRICE EACH: \$ 29.90
Case Pack: 1 **Color:** Black (110).

Flip Lid



EPPFLID
 Hinged lid for EPP180SW, EPP180LHSW, EPP160SW or EPP140SW
L 23.6" x W 15.7" x H 1.6"
UNIT WEIGHT: 0.9 lbs.
LIST PRICE EACH: \$ 55.25
Case Pack: 1 **Color:** Black (110).



Colored Lids

Use lids to color code for quick content identification or routing.



EPP180LID
 Colored lid for EPP180SW, EPP160SW
L 23.6" x W 15.7" x H 1.3"
UNIT WEIGHT: 0.6 lbs.
LIST PRICE EACH: \$ 29.90 / \$19.15 (BLK)
Case Pack: 1 **Colors:** Red (365), Blue (362), Black (110).



Plastic ID Labels



EPPID5
 Plastic ID labels fits all Cam GoBoxes
LIST PRICE EACH: \$ 10.75
Case Pack: 1 **Color:** (000).

Plug In to the Future of HOT and COLD

THE PRO CART ULTRA[®] PAN CARRIERS

Power ON,
set the Temp
and **Go!**

Energy EFFICIENT

Hot & Cold Food
IN A SINGLE CART

Interchangeable MODULES



The PRO CART ULTRA[®] PAN CARRIERS



PCU800
8, 4" deep
GN Food Pans

PCU1000
10, 4" deep
GN Food Pans

PCU1600
16, 4" deep
GN Food Pans

PCU2000
20, 4" deep
GN Food Pans



ELECTRIC HOT

Adjustable temperature from 70° to 185°F, heat up to 165°F in 15 min.

Recovery Time:
Average 20 sec.



ELECTRIC COLD

Adjustable temperature from 32.5° to 70°F without a compressor.

Recovery Time:
PCU1000 / Average 23 sec.
PCU2000 / Average 30 sec.



NON-ELECTRIC PASSIVE

Holds hot or cold foods for 4 + hours.

(Recovery time based on ambient temp. of 74°F) Empty Compartments

Electrical Cord Storage

PCU1000 / PCU2000 ONLY



The PRO CART ULTRA[®] PAN CARRIERS

Holding Capacity

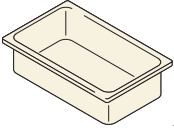
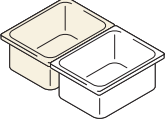
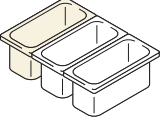
GN FOOD PANS	FOOD PAN DEPTHS															
	2 1/2" (6,5 cm)				4" (10 cm)				6" (15 cm)				8" (20 cm)			
GN 1/1 	12	14	24	28	8	10	16	20	6	6	8	12	4	4	4	8
GN 1/2 	24		28		16		20		12		12		8		8	
GN 1/3 	36		36		24		24		18		18		12		12	
	PCU800	PCU1000	PCU1600	PCU2000												

CODE	DESCRIPTION	DIMENSIONS W x D x H	PRODUCT WEIGHT (LBS/KG)	LIST PRICE EA.
PCU800				
PCU800HH	2 active hot compartments	21.9" x 34" x 59.1" (55,63 x 86,36 x 150,1 cm)	101.94 / 46,24	\$ 6,830.00
PCU800HC	1 active hot compartment (top), 1 active cold compartment (bottom)		110.69 / 50,21	8,640.00
PCU800CC	2 active cold compartments		119.44 / 54,18	10,445.00
PCU800PP	2 passive compartments		89.88 / 40,77	3,550.00
PCU1000				
PCU1000HH	2 active hot compartments	22" x 34" x 67" (55,88 x 86,36 x 170,18 cm)	143.5 / 65,1	7,955.00
PCU1000HC	1 active hot compartment (top), 1 active cold compartment (bottom)		152.25 / 69,06	10,035.00
PCU1000CC	2 active cold compartments		161 / 73,03	12,115.00
PCU1000PP	2 passive compartments		131.44 / 60	4,380.00
PCU1600				
PCU1600HH	2 active hot compartments	30" x 38" x 59" (76,2 x 96,52 x 149,86 cm)	162.25 / 73,6	8,990.00
PCU1600HC	1 active hot compartment (top), 1 active cold compartment (bottom)		171 / 77,57	11,000.00
PCU1600CC	2 active cold compartments		179.75 / 81,31	13,000.00
PCU1600PP	2 passive compartments		150.19 / 68,13	5,480.00
PCU2000				
PCU2000HH	2 active hot compartments	30" x 38" x 68" (76,20 x 96,52 x 172,72 cm)	189.94 / 86,16	9,485.00
PCU2000HC	1 active hot compartment (top), 1 active cold compartment (bottom)		198.69 / 90,12	11,570.00
PCU2000CC	2 active cold compartments		207.44 / 94,1	13,655.00
PCU2000PP	2 passive compartments		177.88 / 80,69	5,940.00
Modules				
PCM CX	Cold Module	—	20.72 / 9,42	4,065.00
PCM HX	Hot Module	—	11.97 / 5,44	2,055.00
PCM PX	Passive Module	—	5.95 / 2,7	300.00

Case Pack: 1 Color: Charcoal Gray (615). Other configurations and Security Package available. Tow Hitch Package Available for PCU2000 Only.

[Click here for 220V models](#)



PRO CART ULTRA® — ELECTRIC & NON-ELECTRIC INSULATED HOLDING & TRANSPORT CABINETS



The Pro Cart Ultra is the ultimate food transport cart that can hold all your hot and cold menu items in the same cart, at the same time—without a compressor!

- Hold and transport hot and cold foods in a single cart.
- Maintains food quality and moisture.

- Keep food safe while unplugged 4 hours.
- Change hot to cold or cold to hot with a simple hardware change.
- Universal rails fit food pans, sheet pans and more.

Color: Charcoal Gray (615).

Multiple International Certifications available.



ELECTRIC HOT

Hot holding cycles between 150° - 165°F.

NON-ELECTRIC PASSIVE

Holds hot or cold foods for 4+ hours.

ELECTRIC COLD

Cold holding cycles between 32.5° - 40°F without a compressor.

Hot, cold and passive modules are also sold separately to quickly outfit the cart to suit your menu.

Temperature Retention of Passive and Unplugged Electric Models

Hot — temperature loss averaging 3°F/hour.

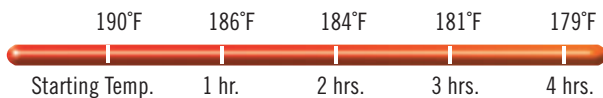

Cold — temperature gain averaging 0.7°F/hour.

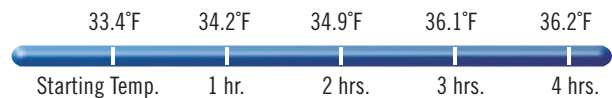

Capacity per Compartment

TYPE OF CONTAINER	STANDARD CAPACITY	STANDARD CAPACITY RAIL SPACING
18" x 26" FULL SIZE SHEET PANS	5	3"
13" x 18" HALF SIZE SHEET PANS	10	3"
GN 1/1 HOTEL PANS (2½" DEEP)	10	4.5"
GN 1/1 HOTEL PANS (4" DEEP)	10	4.5"
60 x 40 cm EURO BAKING SHEETS	5	3"
16" x 16" x 2" PIZZA BOXES	5	3"

Standard rails: 5 rails / compartment *Additional rails required.

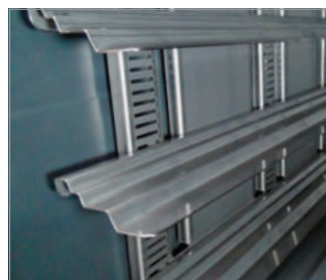

Adjustable rails can be set in any position and easily changed when needed.

PRO CART ULTRA® – FEATURES AND TOW HITCH KIT

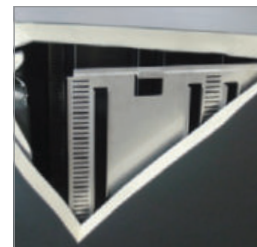

INSULATION
CFC-free, polyurethane insulation throughout the body and doors maximizes heat or cold retention for 4 hours or more with no electricity needed.



4" NYLON LATCHES AND ADJUSTABLE HINGES
For easy opening and closing and to secure contents during transport. (Door is lockable).

GASKET-FREE DOOR
For easy cleaning and fewer replacement parts. Door opens full 270°.

SOLAR DIGITAL THERMOMETER
Monitor internal cabinet temperature at a glance.



5" x 8" MENU POCKET
Allows for easy product ID with either an index card or by writing directly onto smooth surface with a grease pencil.

STAINLESS STEEL HINGE
For long term durability.

POLYETHYLENE EXTERIOR
Keeps food moist naturally and remains cool to the touch during operation, unlike metal cabinets.

STANDARD 6" x 2" HEAVY DUTY CASTERS
Two non-marking, high-performance, all swivel casters with brakes in the front and two rigid casters in the back for smooth positioning and navigation.

Pro Cart Ultra Tow Hitch Kit

Tow your Pro Cart Ultra to your loading dock, serving location and back to your kitchen with the Cambro Tow Hitch Kit. The tow hitch is designed to securely connect your Pro Cart Ultra to any service vehicle with towing capability.

- Fits all Pro Cart Ultra models, low and tall.
- Kit available with standard or security hardware.
- Maximum tow capacity 2,000 pounds.



CODE	DESCRIPTION	UNIT WEIGHT	LIST PRICE EA.
PCUTOW	Pro Cart Ultra Tow Hitch	35 lbs.	\$ 1,805.00
PCUTOWSP	Pro Cart Ultra Tow Hitch Security Package	35	1,990.00

Case Pack: 1 Color: (000). SP package includes tamper-resistant screws.

PRO CART ULTRA® – ELECTRIC



Powerful Performance, Low Power Consumption

- Energy efficient, active modules draw less than 5 amps each.
- Cold module uses environmentally friendly, thermoelectric technology.
- Plugs into a standard outlet.

COLD

Digital controller allows cold to be set from 32.5° to 40°F.

Thermoelectric Cooling Down to 32.5°F

Cool without a compressor for the ultimate in cold mobility and food safety on the go.

Note: Operate in 90°F or less ambient temperature for best results.

Pre-chill time:

90 minutes to 40°F.

(Tested at 73°F ambient.)

Recovery time:

10 minutes after door open for 30 seconds.

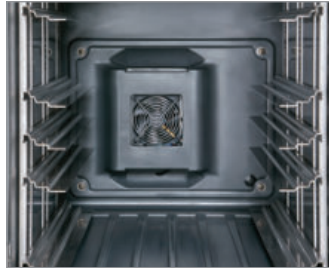

Interior with Cold module



Exterior back with Cold module

HOT

Keeps food safely between 150° to 165°F with convenient, pre-set, gentle, non-radiant heat.

Energy-Saving Heater Less Than 5 Amps

Gentle, non-radiant heat circulates consistently from front to back of the cabinet.

Pre-heat time:

45 minutes.

Recovery time:

3 minutes after door open for 30 seconds.



Interior with Hot module



Exterior back with Hot module

Just 5 Minutes to Change Module

- Seasonal menus
- Menu changes
- Additional budget availability
- Different location or facility
- New trends

Electrical Specifications (Per Compartment)



	HOT 110V	HOT 220V	COLD
REQUIRED VOLTAGE	100-125 VAC	200-230 VAC	100-230 VAC
MAXIMUM AMP	4.6a	2.3a	3.26a, 1.42a
WATTS / HEATER OR COOLER	529w	506w	326.6w
HERTZ	50/60	50/60	50/60
PHASE	Single	Single	Single
ALTERNATE PLUG TYPES FOR INTERNATIONAL*	US, Canada, Mexico, Europe, UK, Ireland, Australia, South Africa, China, Japan		
POWER CORD LENGTH	9 ft.	9 ft.	9 ft.

*If country is not listed, please call Cambro Customer Service for details.



PRO CART ULTRA® – MODEL SPECIFICATIONS



	CODE	DESCRIPTION	UNIT WEIGHT	LIST PRICE EA.
TALL PROFILE  3 = 220V US/CAN/Mexico	Both Compartments Passive (Non-electric)			
	PCUPP	Both compartments non-electric / passive	235.2 lbs.	\$ 7,950.00
	Both Compartments Hot			
	PCUHH	110V standard USA / CAN power cord 5-15P	267.5	11,215.00
	PCUHH3	220V USA / CAN power cord 6-15P	268.4	11,215.00
	Both Compartments Cold			
	PCUCC	110V standard USA / CAN power cord 5-15P	278.4	16,100.00
	PCUCC3	220V USA / CAN power cord 6-15P	283.8	16,100.00
	Combination Hot & Cold			
	PCUHC	Top compartment hot, bottom cold. 110V standard USA / CAN power cord 5-15P	271	14,630.00
	PCUCH	Top compartment cold, bottom hot. 110V standard USA / CAN power cord 5-15P	271	14,630.00
	PCUHC3	Top compartment hot, bottom cold. 220V standard USA / CAN power cord 6-15P	271.4	14,630.00
	PCUCH3	Top compartment cold, bottom hot. 220V standard USA / CAN power cord 6-15P	271.4	14,630.00
	Combination Passive & Hot or Cold			
	PCUPH	Top compartment passive, bottom hot. 110V standard USA / CAN power cord 5-15P	255.3	10,105.00
	PCUPC	Top compartment passive, bottom cold. 110V standard USA / CAN power cord 5-15P	260.8	11,065.00
	PCUPH3	Top compartment passive, bottom hot. 220V standard USA / CAN power cord 6-15P	255.8	10,105.00
	PCUPC3	Top compartment passive, bottom cold. 220V standard USA / CAN power cord 6-15P	263.5	11,065.00
LOW PROFILE 	PCULP	Non-electric / passive	140	5,005.00
	PCULH	Hot Cart, 110V standard USA / CAN power cord 5-15P	151	6,945.00
	PCULC	Cold Cart, 110V standard USA / CAN power cord 5-15P	156	9,205.00
	PCULH3	Hot Cart, 220V standard USA / CAN power cord 6-15P	151	6,945.00
	PCULC3	Cold Cart, 220V standard USA / CAN power cord 6-15P	156	9,205.00

Case Pack: 1 **Color:** Charcoal Gray (615). **Standard Railing Includes:** 5 pairs of stainless steel Universal rails/compartments. Includes Standard Casters: 6" x 2" heavy duty swivel with brake in front, rigid in back.

Unit Dimensions

UNIT	EXTERIOR DIM. W x D x H	COMPARTMENT DIM. W x D x H
Tall Profile		
COLD	28" x 36½" x 66"	21⅞" x 26¼" x 25½"
HOT / PASSIVE	28" x 35¾" x 66"	21⅞" x 27" x 25½"
Low Profile		
COLD	28" x 36½" x 40"	21⅞" x 26¼" x 25½"
HOT / PASSIVE	28" x 35¾" x 40"	21⅞" x 27" x 25½"

Optional Accessories

CODE	DESCRIPTION	LIST PRICE EA.
PCMH / PCMH3	Hot module unit 110V / 220V	\$ 2,120.00
PCMC / PCMC3	Cold module unit 110V / 220V	3,610.00
SSR1	1 Pair of Rails	108.25
SSR5	5 Pairs of Rails	541.25

Case Pack: 1 **Module Unit Color:** Charcoal Gray (615).

Security Package (SP)

Specially designed for operations where safety and security are a top priority. To order add SP after the product code or visit cambro.com for a listing of codes.

- Tamper resistant fasteners secure side column panels to the cart.
- Cross locking rods behind column panels lock 5 rails in place.
- Each compartment holds ten 4" deep hotel pans.
- Passive and electrical modules and cord strap keepers are secured in place with tamper resistant fasteners.
- Non removable doors. Lockable hasp secures both doors at once. (Lock not included).
- Heavy duty casters mounted with tamper resistant fasteners.

All models are also available without rails and side column panels. Please visit cambro.com for details.



INSULATED FOOD SERVERS (ELECTRIC) – CAMTHERM® ELECTRIC FOOD HOLDING CABINETS



Hot Only Models

Go From Hot to Cold in One Versatile Cart!

- Use for bulk food holding in the kitchen or to transport large amounts of food off-site.
- Go from hot to cold with the simple flip of a switch!
- Tough polyethylene exterior will not dent, rust or chip; stays cool to the touch during operation, unlike metal cabinets.
- Thick polyurethane foam insulation maintains safe food holding temperatures for 4 hours or more, even unplugged.
- Available in two sizes and hot only or hot/cold models.

Energy-efficient thermoelectric heating and cooling with:

No Compressor, heating coil or humidifier.

Low voltage, amps, wattage.



48%
More
Energy
Efficient

Than Leading Metal Cabinets

INSULATED FOOD SERVERS (ELECTRIC)



Camtherm® Electric Food Holding Cabinets

NUCKLE DOOR HINGES

Withstand rigorous door openings, allows door to be lifted up and off for easy cleaning.

DOOR SWINGS OPEN 270°

For easy loading.

MARINE RAILING

Holds 2 full-sized food pans, 1 full-sized sheet pan or cutting board (CB1220).

SOLAR DIGITAL THERMOMETER

Monitor internal temperature at a glance.

SELF-VENTING CAP

Releases steam and equalizes pressure, maintaining food quality.

MENU CLIP

For easy product/event identification.

ADJUSTABLE CHROME-PLATED STEEL SLIDE RAILS

Hold full-size food pans or sheet pans.

POLYETHYLENE EXTERIOR

Stays cool to the touch during operation.

ERGONOMIC MOLDED-IN HANDLES

For easy maneuvering even when fully loaded.

ALUMINUM LOUVERS

Gently circulate hot or cold air evenly.

WIDE NYLON DOOR LATCHES/MAGNETIC DOOR GASKETS

Lock doors securely and create a tight seal to retain safe hot or cold food temperatures.

MOLDED-IN BUMPERS

Protect walls and furniture.

CONTROL PANEL (in back) On/Off switch
Temperature control dial for hot only models.
Hot pre-set between 150° to 165°F.

Hot/Cold switch for Hot/Cold Models only.
Cold pre-set to 37°F.

TRANSITION TIME

Cold to Hot: 1.5 to 2.5 hrs.
Hot to Cold: 3 hrs.

Camtherm® Electrical Specifications



ELECTRICAL SPECIFICATIONS

	LOW PROFILE HOT ONLY	LOW PROFILE HOT/COLD	TALL PROFILE HOT ONLY	TALL PROFILE HOT/COLD
VOLTS	110V	110V	110V	110V
PLUG TYPE	Nema 5-15P	Nema 5-15P	Nema 5-15P	Nema 5-15P
MAXIMUM AMP DRAW	9.1 amps	10.7 amps	14 amps	14.3 amps
AMPS RUN ON	9 amps	10.1 amps	13.8 amps	13.6 amps
WATTS	1035	1162	1587	1570
HERTZ	50/60	50/60	50/60	50/60
POWER INPUT OF HEATING UNIT	110-120 VAC	110-120 VAC	110-120 VAC	110-120 VAC

Assembly is covered by U.S. Patent D 442,756 S & D 6,344,630.

INSULATED FOOD SERVERS (ELECTRIC)

Camtherm® Capacity Specifications

HOLDING CAPACITY	LOW PROFILE	HIGH PROFILE
Sheet Pans		
18" x 26"	11*	22**
Full-Size Food Pans		
2½" Deep	12	24
4" Deep	8	16
6" Deep	6	12
8" Deep	4	8

*Requires five additional rail sets **Requires five additional rail sets.

Security Package







Specially designed for operations where safety and security are a top priority.

- Tamper-resistant fasteners.
- One-piece, welded and secured rail and upright assembly.
- Lockable hasp on each door (padlocks not included).



Product Specifications

CAD drawings, cut sheets and user manual available at www.cambro.com.

	CODE	THERMOMETER	CASTERS	UNIT WEIGHT	LIST PRICE EA.
  	LOW PROFILE				
	EXTERIOR dimensions: W 30½" x D 42" x H 42¾"				
	Hot Only				
	CMBH1826LF	Fahrenheit	2 front 6" swivel w/brake, 2 rear 10" rigid	164 lbs.	\$ 8,400.00
	CMBH1826LC	Celsius	2 front 6" swivel w/brake, 2 rear 10" rigid	164	8,400.00
	Hot/Cold				
	CMBHC1826LF	Fahrenheit	2 front 6" swivel w/brake, 2 rear 10" rigid	222	19,445.00
	CMBHC1826LC	Celsius	2 front 6" swivel w/brake, 2 rear 10" rigid	222	19,445.00
	LOW PROFILE WITH SECURITY PACKAGE (SP)				
	Hot Only				
CMBH1826LSP	Fahrenheit	2 front 6" swivel w/brake, 2 rear 10" rigid	167.4	8,645.00	
Hot/Cold					
CMBHC1826LSP	Fahrenheit	2 front 6" swivel w/brake, 2 rear 10" rigid	225.4	19,890.00	
  	TALL PROFILE				
	EXTERIOR dimensions: W 30½" x D 39" x H 64¾"				
	Hot Only				
	CMBH1826TSF	Fahrenheit	2 front 6" swivel w/brake, 2 rear 6" rigid	250 lbs.	\$ 12,885.00
	CMBH1826TBF	Fahrenheit	2 front 6" swivel w/brake, 2 rear 10" rigid	254	12,885.00
	CMBH1826TSC	Celsius	2 front 6" swivel w/brake, 2 rear 6" rigid	250	12,885.00
	CMBH1826TBC	Celsius	2 front 6" swivel w/brake, 2 rear 10" rigid	254	12,885.00
	Hot/Cold				
	CMBHC1826TSF	Fahrenheit	2 front 6" swivel w/brake, 2 rear 6" rigid	325.5	27,315.00
	CMBHC1826TBF	Fahrenheit	2 front 6" swivel w/brake, 2 rear 10" rigid	330	27,315.00
	CMBHC1826TSC	Celsius	2 front 6" swivel w/brake, 2 rear 6" rigid	325.5	27,315.00
	CMBHC1826TBC	Celsius	2 front 6" swivel w/brake, 2 rear 10" rigid	330	27,315.00
	TALL PROFILE WITH SECURITY PACKAGE (SP)				
Hot Only					
CMBH1826TSP	Fahrenheit	2 front 6" swivel w/brake, 2 rear 10" rigid	260.77	13,605.00	
Hot/Cold					
CMBHC1826TSP	Fahrenheit	2 front 6" swivel w/brake, 2 rear 10" rigid	337	28,070.00	
Cabinet Colors: Granite Gray (191), Granite Green (192), Granite Sand (194).					

ACCESSORIES	CODE	DESCRIPTION	DIMENSIONS L x W x H	CASE PACK	LIST PRICE EA.
	CMBR	Set of slide rails	20" x 4¼"	1 set of 2 Rails	\$ 90.40
	CB1220	Cutting board	21" x 13½" x ½"	1 each	69.80

Cutting Board Color: White (148). Venting plug is covered by US Patent D 553,717 S.

INSULATED FOOD SERVERS (ELECTRIC)

Ultra Pan Carrier® and Ultra Camcart® H-Series

- Designed for both electric hot holding and non-electric transport.
- Gentle, 150° to 165°F non-radiant heat will not cook food and maintains food moisture.
- Holds a wide variety of foods such as pasta, bone-in fried chicken, and double-crusting pies.
- One hour preheat time from room temperature and three minute recovery.
- Energy consumption is substantially less than comparable metal cabinets.
- Will not rust or dent like metal cabinets, is more economical, and is easy to maneuver.
- All UPCH models have been tested to maintain safe, hot food temperatures, for up to 4 hours when unplugged.
- Models with only the top heated door offer unique versatility with an electric hot holding cabinet on top and passive hot or cold food holding on the bottom.
- Heated door kits also sold separately to retrofit UPC400, UPC800 and UPC1600.

Colors: Granite Gray (191), Granite Green (192), Slate Blue (401), Dark Brown (131), Black (110).

Casters: 6" - 2 fixed, 2 swivel, 1 with brake.



Power On and Heat On Indicators

Communicate the Power and Heating status of the UPCH1600 unit. Know instantly when the compartment has reached target temperature.



Vents

Consistent heating throughout the compartment is generated by vents that constantly circulate heat from front to back.



Tough Exterior

All UPCH units are made of tough polyethylene with polyurethane foam insulation to keep heat in while keeping the exterior cool to the touch. Will not crack, dent, chip, rust or break.



Insulation

CFC-free, foamed-in place polyurethane foam insulation will hold temperature above 148°F for up to 4 hours when used unplugged.

INSULATED FOOD SERVERS (ELECTRIC)

Ultra Pan Carrier® and Ultra Camcart® H-Series

Marine rail is designed for use during service, not transport.



UPCH400 / 4002

UPCH800 / 8002

UPCH1600 / 16002

MODEL	UPCH400/ UPCH800 (110 VAC MODELS)	UPCH4002/ UPCH8002* (220 VAC MODELS)	UPCH1600 (110 VAC MODELS)	UPCH16002* (220 VAC MODELS)
Electrical Specifications				
REQUIRED VOLTAGE	110 – 120 VAC	200 – 230 VAC	110 – 125 VAC	200 – 230 VAC
MAXIMUM AMP.	2.0a	1.2a	4.6a	1.2a
WATTS	230w	265w	529w	265w
HERTZ	50/60	50/60	50/60	50/60
PLUG TYPE	Nema 5-15P	Euro plug, CEE7	5-15P to C15RA	CEE7/7 to C15RA
POWER CORD LENGTH	9 feet	2,7 m	9 feet	2,7 m

*No U.S. 220V model available.

Hot — temperature loss averaging 3°F/hour when unplugged.

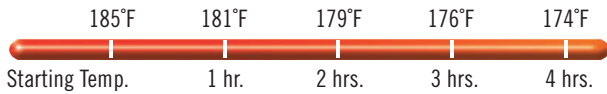

HOT HOLDING	150° — 165°F
WARM UP TIME (from ambient to temperature)	1 hour
RECOVERY TIME* (time to recover to temperature after door is held open for 30 seconds)	3 minutes
TRANSPORT TIME* (after reaching temperature, amount of time unit can be held passively/unplugged until contents reach 148°F.)	4 hours+

*Based on test with 4 full-sized, 4" deep H-Pans™ filled with 190°F hot water.

Capacity Guide

UPCH400
UPCH800 (x2)
UPCH1600 (x4)

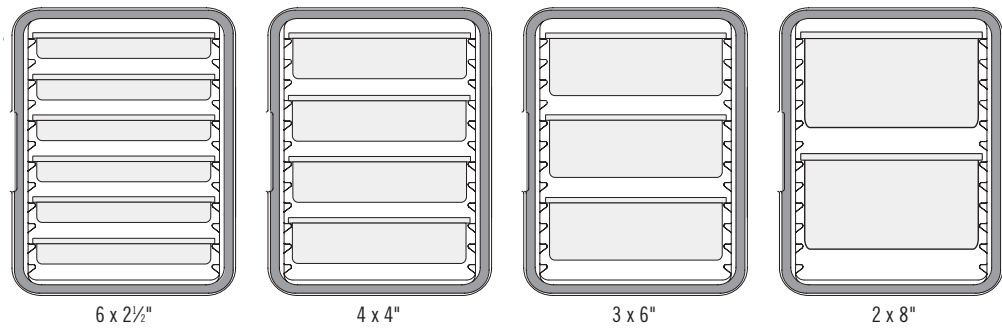

Food Pan Portion Guide

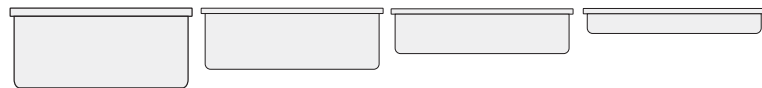

GN 1/1 FOOD PAN	8"	6"	4"	2 1/2"
DEPTH	8"	6"	4"	2 1/2"
SERVING PORTIONS PER PAN (1 CUP)	80	60	40	30

INSULATED FOOD SERVERS (ELECTRIC)

Ultra Pan Carrier® and Ultra Camcart® H-Series

Colors: Granite Gray (191),
Granite Green (192), Slate Blue (401),
Black (110), Dark Brown (131).



- Enables HACCP compliance by maintaining safe, hot food temperatures.
- UPCH400 models stack for storage or transporting on a Camdolly® with securing strap.

Security Package (SP)

Specially designed for operations where safety and security are a top priority.

- Tamper-resistant fasteners.
- Non-removable doors.
- Lockable hasp on each door (padlocks not included).
- Heavy duty (HD) casters with chassis plates mounted with tamper resistant bolts.

CODE	CASTERS	LIST PRICE EA.
UPCH1600SP	6" x 2"	\$ 8,130.00
UPCH16002SP	6" x 2"	8,130.00



Store
Safe

CODE	DESCRIPTION	EXTERIOR DIMENSIONS W x D x H	RAIL TO RAIL DIMENSIONS W x D x H	LIST PRICE EA.
1-Compartment Ultra Pan Carriers				
110V				
UPCH400	No casters	18 ³ / ₈ " x 26 ³ / ₈ " x 24 ⁷ / ₈ "	12" x 21" x 19 ¹ / ₈ "	\$ 1,985.00
UPCHW400	With casters	18 ³ / ₈ " x 26 ³ / ₈ " x 31 ¹ / ₄ "	13 ³ / ₈ " x 21" x 19 ¹ / ₈ "	2,250.00
220V*				
UPCH4002	No casters	18 ³ / ₈ " x 26 ³ / ₈ " x 24 ⁷ / ₈ "	13 ³ / ₈ " x 21" x 19 ¹ / ₈ "	1,985.00
UPCHW4002	With casters	18 ³ / ₈ " x 26 ³ / ₈ " x 31 ¹ / ₄ "	13 ³ / ₈ " x 21" x 19 ¹ / ₈ "	2,250.00
2-Compartment Ultra Camcarts				
110V				
UPCH800	Both doors heated	20 ¹ / ₂ " x 27 ¹ / ₈ " x 54"	12" x 21 ¹ / ₂ " x 19 ¹ / ₈ "	4,870.00
UPCHT800	Top door heated only	20 ¹ / ₂ " x 27 ¹ / ₈ " x 54"	13" x 21 ¹ / ₂ " x 19 ¹ / ₈ "	3,710.00
UPCH1600	Both doors heated	28 ³ / ₄ " x 33 ³ / ₈ " x 54 ¹ / ₈ "	19 ³ / ₄ " x 26 ³ / ₈ " x 21"	7,890.00
UPCH1600HD	Both doors heated, HD casters	28 ³ / ₄ " x 33 ³ / ₈ " x 54 ¹ / ₂ "	19 ³ / ₄ " x 26 ³ / ₈ " x 21"	8,115.00
UPCHT1600	Top door heated only	28 ³ / ₄ " x 33 ³ / ₈ " x 54 ¹ / ₈ "	19 ³ / ₄ " x 26 ³ / ₈ " x 21"	6,150.00
UPCHT1600HD	Top door heated only, HD casters	28 ³ / ₄ " x 33 ³ / ₈ " x 54 ¹ / ₂ "	19 ³ / ₄ " x 26 ³ / ₈ " x 21"	6,365.00
220V*				
UPCH8002	Both doors heated	20 ¹ / ₂ " x 27 ¹ / ₈ " x 54"	12" x 21 ¹ / ₂ " x 19 ¹ / ₈ "	4,870.00
UPCHT8002	Top door heated only	20 ¹ / ₂ " x 27 ¹ / ₈ " x 54"	12" x 21 ¹ / ₂ " x 19 ¹ / ₈ "	3,710.00
UPCH16002	Both doors heated	28 ³ / ₄ " x 33 ³ / ₈ " x 54 ¹ / ₈ "	19 ³ / ₄ " x 26 ³ / ₈ " x 21"	7,890.00
UPCH16002HD	Both doors heated, HD casters	28 ³ / ₄ " x 33 ³ / ₈ " x 54 ¹ / ₂ "	19 ³ / ₄ " x 26 ³ / ₈ " x 21"	8,115.00
UPCHT16002	Top door heated only	28 ³ / ₄ " x 33 ³ / ₈ " x 54 ¹ / ₈ "	19 ³ / ₄ " x 26 ³ / ₈ " x 21"	6,150.00
UPCHT16002HD	Top door heated only, HD casters	28 ³ / ₄ " x 33 ³ / ₈ " x 54 ¹ / ₂ "	19 ³ / ₄ " x 26 ³ / ₈ " x 21"	6,365.00
Accessories for 1-Compartment		W x D x H	W x D	
CD400	Camdollies®	21 ¹ / ₁₆ " x 28 ³ / ₈ " x 9"	18 ¹ / ₂ " x 25 ¹ / ₁₆ "	478.00
400STP	150" long strap	—	—	29.70

UPCH Case Pack: 1 *No U.S. 220V model available.

Also Available: Top and Bottom Replacement/Retrofit Doors for 110V and 220V (non-interchangeable).

InStock Colors: Black (110), Dark Brown (131).

Standard Casters: 6" x 1¹/₄" – 2 fixed, 2 swivel, 1 with brake.

Heavy Duty (HD) Casters: 6" x 2" – 2 fixed, 2 swivel with brake.

INSULATED FOOD SERVERS (NON-ELECTRIC)



Multiple GN Food Pan, Front-Loading Carts

- Double-compartment, high-capacity carts hold and transport hot or cold food.
- Tough, polyethylene shell and thick foam insulation throughout cabinet and between compartments maintain safe food temperatures for 4 hours or more.
- Easy to maintain and won't dent, crack, rust, or chip.
- Durable nylon door latches open easily and close securely.
- Full-swing doors open to the side of the cart for easy loading and unloading.
- Airtight removable gaskets
- Molded-in handles ensure easy maneuvering.
- Molded-in bumpers minimize damage to walls, furniture and other equipment.

Colors: Navy Blue (186), Slate Blue (401), Coffee Beige (157), Dark Brown (131), Brick Red (402), Green (519), Black (110), Hot Red (158), Granite Gray (191), Granite Green (192), Granite Sand (194).

Note: Place food pans on rails. Pans should not be placed on the floor of a Camcart cavity. Please use specified food pan sizes.

Note: Best results will be achieved by loading food pans between 180° to 190°F. Loading metal food pans over 250°F may result in damage to the carrier or cart.

Venting plug is covered by US Patent D 553,717 S.



Marine rail is designed for use during service, not transport.

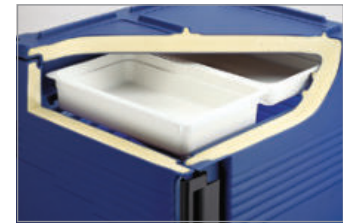

Polyurethane insulation keeps hot food hot and cold food cold.



Shown with optional HD casters.

TOTAL CART HOLDING CAPACITY	UPC600	UPC800	UPC1200	UPC1600
Full Size Food Pans				
2½" deep	8 pans	12 pans	16 pans	24 pans
4" deep	6 pans	8 pans	12 pans	16 pans
6" deep	4 pans	6 pans	8 pans	12 pans
8" deep	2 pans + 2 each 4" pans	4 pans	4 pans	8 pans
Camtray®**				
3253	12 trays	24 trays	24 trays	48 tray
2632	24 trays	48 tray	—	—
2025	—	—	12 trays	24 trays

See Food Pan and Camtray Section for pricing and ordering information.
*Based on 3" spacing between trays.

Hot — temperature loss averaging 3°F/hour.

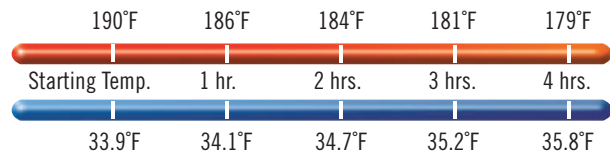

Cold — temperature gain averaging 1.5°F/hour.

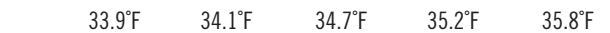

INSULATED FOOD SERVERS (NON-ELECTRIC)



Ultra Camcarts®



CODE	UPC600	UPC800 (UPC800SP)	UPC1200
DESCRIPTION	Base model	Base model (Security package)	Base model
EXTERIOR DIM. W x D x H	20½" x 27⅞" x 45"	20½" x 27⅞" x 54"	28½" x 32¼" x 45½"
RAIL TO RAIL DIM. W x D x H	11¾" x 21⅙" x 14"	12" x 21½" x 19⅞"	19¾" x 26⅞" x 13½"
CASTERS	5" x 1¼" casters	6" x 1¼" (6" x 1½" HD casters)	6" x 1¼" casters
TEMPERATURE MAINTENANCE TOOLS	1210PW Camwarmer®, 300DIV ThermoBarrier®, CP3253 and CP2632 Camchiller®	1210PW Camwarmer, 400DIV ThermoBarrier, CP3253 and CP2632 Camchiller	1200DIV Thermo Barrier, CP3253 Camchiller
LIST PRICE EACH	\$ 1,730.00	\$ 2,040.00 (\$ 2,200.00)	\$ 2,610.00

Case Pack: 1 Casters: 5" or 6" x 1¼", 2 fixed, 2 swivel, 1 with brake. **Heavy Duty (HD) Casters:** 6" x 1½", 2 fixed, 2 swivel with brake casters.



Security Package (SP)

Specifically designed for operations where safety and security are a top priority.

- Tamper-resistant fasteners.
- Non-removable doors.
- Lockable hasp on each door (padlocks not included).
- Heavy duty (HD) casters with chassis plates mounted with tamper resistant bolts.



CODE	UPC1600	UPC1600HD	UPC1600SP	UPC6L1600SP
DESCRIPTION	Base model	Base model with HD casters	Security package	Security package, gasketless
EXTERIOR DIM. W x D x H	28¾" x 33⅞" x 54½"	28¾" x 33⅞" x 54½"	28¾" x 33⅞" x 54½"	28¾" x 33⅞" x 54½"
RAIL TO RAIL DIM. W x D x H	19¾" x 26⅞" x 21"	19¾" x 26⅞" x 21"	19¾" x 26⅞" x 21"	19¾" x 26⅞" x 21"
CASTERS	6" x 1¼" casters	6" x 2" HD casters	6" x 2" HD casters	6" x 2" HD casters
TEMPERATURE MAINTENANCE TOOLS	1600DIV ThermoBarrier, CP3253 Camchiller	1600DIV ThermoBarrier, CP3253 Camchiller	1600DIV ThermoBarrier, CP3253 Camchiller	1600DIV ThermoBarrier, CP3253 Camchiller
LIST PRICE EACH	\$ 3,750.00	\$ 3,945.00	\$ 4,100.00	\$ 3,785.00

Case Pack: 1 Casters: 5" or 6" x 1¼", 2 fixed, 2 swivel, 1 with brake. **Heavy Duty (HD) Casters:** 6" x 2", 2 fixed, 2 swivel with brake casters.

INSULATED FOOD SERVERS

CAMCARTS[®]

Reimagined



For Trays and
Sheet Pans



1826DTC
L 21.5" x W 33.25" x H 63.75"
LIST PRICE EACH: \$ 3,240.00

For
Food Boxes



1826DBC
L 21.5" x W 33.25" x H 63.75"
LIST PRICE EACH: \$ 3,240.00

IMPROVED ERGONOMICS
with two molded-in vertical
handles for easy maneuvering

ROBUST
Stainless
Steel Hinges



INSULATED FOOD SERVERS (NON-ELECTRIC)



Camcarts®

- Holds sheet pans, trays and food boxes.
- Includes removable cutting board on top.
- Security Package (SP)** features tamper-resistant hardware to protect both cart and contents. Includes chassis plates with 6" x 1½" HD Casters.

Colors: Slate Blue (401), Coffee Beige (157), Dark Brown (131), Navy Blue (186), Charcoal Gray (615).

Standard Casters: 6" x 1¼", 2 fixed, 2 swivel, 1 with brake.

Heavy Duty (HD) Casters: 6" x 1½", 2 fixed, 2 swivel, no brake.

Note: Cool metal sheet pans to 250°F before placing onto tray supports.

Venting plug is covered by U.S. Patent D 553,717S.



Camcart for Food Storage Boxes

1826LBC / 1826LBCSP**

Holds 18" x 26" Food Storage Boxes. 13 supports on 1¼" centers.

EXTERNAL DIM. W x D x H:
21½" x 32" x 37½"

RAIL TO RAIL DIM. W x D x H:
16½" x 26⅞" x 25⅞"

LIST PRICE EACH:
\$ 1,950.00 / \$ 2,420.00

Case Pack: 1



Camcart for Trays and Sheet Pans

1826LTC / 1826LTCSP**

Holds up to 13 each 18" x 26" trays or sheet pans. 13 tray supports on 1¼" centers.

EXTERNAL DIM. W x D x H:
21½" x 32" x 37½"

RAIL TO RAIL DIM. W x D x H:
14⅞" x 26⅞" x 25⅞"

LIST PRICE EACH:
\$ 1,965.00 / \$ 2,460.00

Case Pack: 1



Camcart for Trays and Sheet Pans

1826LTC3

Holds up to 7 each 18" x 26" trays or sheet pans. Seven tray supports on 3¾" centers with 3" clearance between trays.

EXTERNAL DIM. W x D x H:
21½" x 32" x 37½"

RAIL TO RAIL DIM. W x D x H:
14⅞" x 26⅞" x 25⅞"

LIST PRICE EACH: \$ 1,965.00

Case Pack: 1



Camcarriers®

- Holds sheet pans, trays and GN food pans.
- One piece seamless construction with molded-in handles.

Colors: Black (110), Slate Blue (401), Coffee Beige (157), Dark Brown (131), Navy Blue (186), Charcoal Gray (615). 1318CC also available in Hot Red (158).

Refer to Camdollies listing.

Note: Cool metal sheet pans to 250°F before placing onto tray supports.

Venting plug is covered by U.S. Patent D 553,717S.



Combo Carrier

1318CC

Holds half-size sheet pans, trays and a variety of food pan sizes. Safely keeps cold food below 41°F, hot food above 140°F for 4+ hours. Interstacks with UPC300, 300MPC, 1318MTC.

EXTERNAL DIM. W x D x H*:
17" x 25¾" x 22⅞"

RAIL TO RAIL DIM. W x D x H:
12" x 21" x 14"

FITS CAMDOLLY:
CD300, CD300H, CD300HB, CDC300

LIST PRICE EACH: \$ 695.00

Case Pack: 1 *With Handle.



Camcarrier

1826MTC

Holds up to 6 each 18" x 26" sheet pans. Six tray supports on 2⅞" centers.

EXTERNAL DIM. W x D x H*:
21½" x 29¼" x 22½"

RAIL TO RAIL DIM. W x D x H:
15" x 26⅞" x 14⅞"

FITS CAMDOLLY:
CD1826MTC, CD1826MTCB

LIST PRICE EACH: \$ 1,050.00

Case Pack: 1 *With Handle.



1826HAR

Lifting harness.

DIMENSION: 142" long

LIST PRICE EACH: \$ 138.80

Color: Beige (000).

INSULATED FOOD SERVERS (NON-ELECTRIC)



Multiple GN Food Pans, Front-loading Carriers

- Holds GN 1/1, GN 1/2 and GN 1/3 pans.
- One-piece seamless construction for great durability.
- Thick polyurethane insulation safely keeps cold food below 41°F, hot food above 140°F for 4+ hours.
- Fully removable door.
- Labeling area on door for adhering ID or routing labels.

Colors: Black (110), Dark Brown (131), Hot Red(158), Navy Blue (186), Slate Blue (401), Charcoal Gray (615).

UPC300 is covered by US Patent D786,607 S.



Recommended labeling with: 23SLINB250 2" x 3" StoreSafe® Labels.



CODE	UPC300
EXTERIOR DIM. W x D x H	17" x 25 $\frac{3}{4}$ " x 22 $\frac{3}{8}$ "
INTERIOR DIM. W* x D x H	13 $\frac{1}{4}$ " x 21" x 14"
UNIT WEIGHT	23.3 lbs.
FITS CAMDOLLY®	CD300, CD300H, CD300HB, CDC300
LIST PRICE EACH	\$ 665.00

Case Pack: 1 InStock Colors: Dark Brown (131), Black (110). *Rail to Rail Temperature Maintenance Tools: 1210PW Camwarmer®, UPC300DIV ThermoBarrier® and CP3253 Camchiller®.

Hot — temperature loss averaging 3°F/hour.

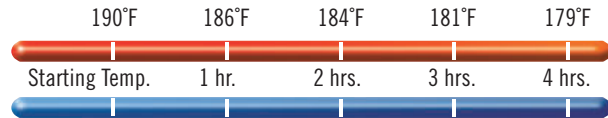

Cold — temperature gain averaging 1.5°F/hour.

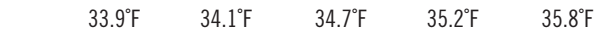

UPC300 Holding Capacity

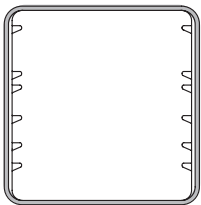

UPC300 rail configuration

DEPTH	GN 1/1	GN 1/2	GN 1/3
2 $\frac{1}{2}$ "	4	8	12
4"	3	6	9
6"	2	4	6
8"	1	2 + two 4"	3 + three 4"

Optional Accessories



CODE	CD300	CD300H
DESCRIPTION	Camdolly	Camdolly with Handles
EXTERIOR DIM.	25 $\frac{1}{2}$ " x 19 $\frac{1}{4}$ " x 10 $\frac{1}{2}$ "	19" x 30 $\frac{1}{2}$ " x 36 $\frac{1}{2}$ "
INTERIOR DIM.	16 $\frac{7}{8}$ " x 23 $\frac{1}{16}$ "	17" x 23 $\frac{1}{2}$ "
LIST PRICE EACH	\$ 429.00	\$ 690.00

Case Pack: 1

Colors: Coffee Beige (157), Dark Brown (131), Black (110), Slate Blue (401).

INSULATED FOOD SERVERS (NON-ELECTRIC)



Ultra Pan Carrier® UPC400

- Fit four 4" deep full-size food pans.
- Hold hot or cold food safely for 4 hours or more.

Colors: Navy Blue (186), Slate Blue (401), Coffee Beige (157), Dark Brown (131), Black (110), Granite Gray (191), Granite Green (192), Granite Sand (194).

UPC400 is covered by US Patent D 392,158. Venting plug is covered by US Patent D 553,717 S.

Note: Place food pans on rails. Pans should not be placed on the floor of a Camcarrier® cavity. Please use specified food pan sizes.

Note: Best results will be achieved by loading food pans between 180° to 190°F (82° to 88°C). Loading metal food pans over 250°F (121°C) may result in damage to the carrier or cart.



ERGONOMIC DESIGN

Unbreakable, ergonomic, molded-in handles for comfortable two-person carrying.



PRESSURE AND HUMIDITY CONTROL
Pop-up vent.



TEMPERATURE RETENTION
Polyurethane insulation keeps hot food hot and cold food cold.



QUICK ACCESS
Single, 9" nylon latch for quick and secure opening and closing.

REMOVABLE GASKET

Provides an airtight seal.

Hot — temperature loss averaging 3°F/hour.

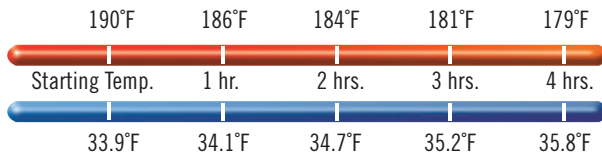

Cold — temperature gain averaging 1.5°F/hour.

CODE

CODE	UPC400 / UPC400SP**
EXTERIOR DIM. W x D x H	18" x 25" x 24 7/8"
INTERIOR DIM. W* x D x H	13 7/8" x 21" x 19 1/2"
UNIT WEIGHT	32 lbs. / 36 lbs.
FITS CAMDOLLY®	CD400, CDC400
LIST PRICE EACH	\$ 785.00 / \$ 870.00

Case Pack: 1 InStock Colors: Coffee Beige (157), Black (110). *Rail to Rail
**Security Package (SP) Model: Tamper-resistant fasteners.
Non-removable doors. Lockable hasp on each door (padlocks not included).

UPC400 Holding Capacity

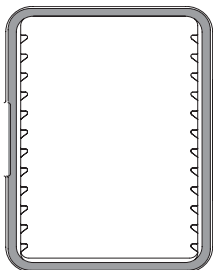

UPC400 rail configuration

HOLDING CAPACITY:

Pan Depth	Number of GN 1/1 pans
2 1/2"	6
4"	4
6"	3
8"	2

Also holds GN 1/2 and 1/3 size pans.

Optional Accessories



CODE	CD400	400STP
DESCRIPTION	Camdolly®	Strap
EXTERIOR DIM.	21 1/16" x 28 3/8" x 9"	150" long
INTERIOR DIM.	18 1/2" x 25 5/16"	—
COLOR	▲	Beige (000)
LIST PRICE EACH	\$ 478.00	\$ 29.70

Case Pack: 1 ▲ CD400 Colors: Coffee Beige (157), Dark Brown (131), Black (110), Slate Blue (401).

INSULATED FOOD SERVERS (NON-ELECTRIC)



Ultra Pan Carrier® S-Series UPCS400

- Fit four 4" deep full-size food pans.
- Hold hot or cold food safely for 4 hours or more.

Colors: Slate Blue (401), Speckled Grey (480), Dark Brown (131).

Note: Place food pans on rails. Pans should not be placed on the floor of a Camcarrier® cavity. Please use specified food pan sizes.

Note: Best results will be achieved by loading food pans between 180° to 190°F. Loading metal food pans over 250°F may result in damage to the carrier or cart.



CONVENIENT
Integrated pan-staging area eases service (not for use during transport).

EASY TO CLEAN
Door removes for easy cleaning.



TEMPERATURE RETENTION
Polyurethane insulation keeps hot food hot and cold food cold.



MENU CLIP
Reduces need to open door.

ERGONOMIC DESIGN
Unbreakable, ergonomic, molded-in handles for comfortable two-person carrying.

QUICK ACCESS
Single, 9" nylon latch for quick and secure opening and closing.



BUILT-IN SEAL
Eliminates need for removable gasket.

PRESSURE CONTROL
Built-in vent.

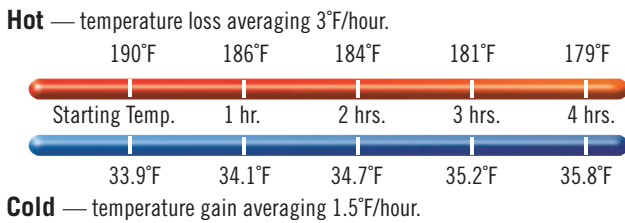

CODE	UPCS400
EXTERIOR DIM. W x D x H	18" x 26¼" x 25"
INTERIOR DIM. W x D x H	13⅝" x 21" x 19⅝"
UNIT WEIGHT	44.3 lbs.
FITS CAMDOLLY	CD400, CDC400
LIST PRICE EACH	\$ 690.00

Case Pack: 1 InStock Colors: Speckled Gray (480), Dark Brown (131).

UPCS400 Holding Capacity

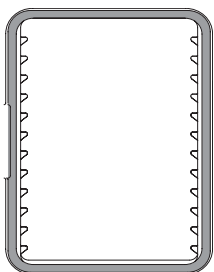

UPCS400 rail configuration

HOLDING CAPACITY:

Pan Depth	Number of GN 1/1 pans
2½"	6
4"	4
6"	3
8"	2

Also holds GN 1/2 and 1/3 size pans.

Optional Accessories



CODE	UPCS400CK	CD400	400STP
DESCRIPTION	Caster Kit*	Camdolly®	Strap
EXTERIOR DIM.	5"	21⅛" x 28⅞" x 9"	150" long
INTERIOR DIM.	—	18½" x 25⅝"	—
COLOR	—	▲	Beige (000)
LIST PRICE EACH	\$ 209.30	\$ 478.00	\$ 29.70

Case Pack: 1 *Optional Caster Kit for UPCS400: 2 fixed, 2 swivel, 1 w/ brake.
▲ CD400 Colors: Coffee Beige (157), Dark Brown (131), Black (110), Slate Blue (401).

INSULATED FOOD SERVERS (NON-ELECTRIC)



Single GN Food Pan, Top-Loading Carriers

- Top-loading food pan carriers hold, transport and serve a single full-size pan of hot or cold food.
- Sturdy and durable, seamless polyethylene or polypropylene with thick foam insulation.
- Molded-in handles on all four sides for easy carrying and handling.
- 100 Series interstacks within the series and 240MPC stacks only with 240MPCs.
- Use with divider bars to hold multiple fractional pans.
- Pans are easy to remove using finger notches.
- Carriers interlock and stack for transporting and storing.

UPCS Colors: Dark Brown (131), Coffee Beige (157), Speckled Gray (480), Black (110).

MPC and MPCHL Colors: Navy Blue (186), Slate Blue (401), Coffee Beige (157), Dark Brown (131), Brick Red (402), Kentucky Green (519), Black (110), Hot Red (158).

UPC Colors: Slate Blue (401), Dark Brown (131), Black (110), Granite Gray (191), Granite Green (192).

See Food Pan Section and Camdolly Section for pricing and ordering information.

Note: Place food pans on rails. Pans should not be placed on the floor of a Camcarrier® cavity.

Note: Best results will be achieved by loading food pans between 180° to 190°F. Loading metal food pans over 250°F may result in damage to the carrier.



Hot — temperature loss averaging 3°F/hour.

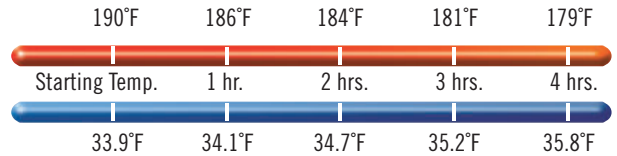

Cold — temperature gain averaging 1.5°F/hour.

UPC140



UPC100
No divider bars available for UPC100.

UPC160
Shown with dividers and fractional sized food pans.

Camcarrier®

One-piece, seamless polyethylene construction, airtight removable gasket and sturdy plastic latches.

CODE	240MPC	100MPCHL
COMPARTMENT CAPACITY	1 half size 2½" deep pan or 1 half size 4" deep pan	1 full size 8" deep pan
EXTERIOR DIM. W x D x H	16½" x 13⅞" x 7½"	26¼" x 18" x 15½"
INTERIOR DIM. W x D x H	13⅞" x 11⅞" x 4"	21¼" x 13¼" x 8"
BULK CAPACITY*	6.3 qts.	40 qts.
FITS CAMDOLLY®	CD1420	CD100, CD100H, CD100HB
LIST PRICE EACH	\$ 397.00	\$ 715.00

Case Pack: 1 *Without using food pans. 240MPC and 100MPCHL No Divider Bar.

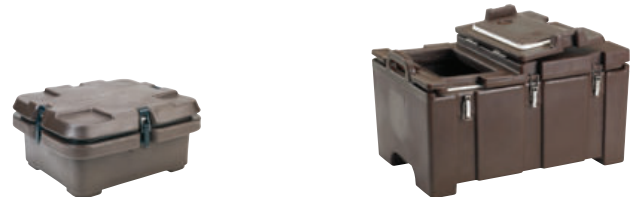

INSULATED FOOD SERVERS (NON-ELECTRIC)



S-Series

Durable polypropylene construction, built in seal and wide, nylon latches.
Contemporary appearance and superior holding performance at an economical price.



CODE	UPCS140	UPCS160*	UPCS180
COMPARTMENT CAPACITY	1 full size 4" deep pan	1 full size 6" deep pan	1 full size 8" deep pan
EXTERIOR DIM. W x D x H	25 $\frac{3}{8}$ " x 17 $\frac{7}{8}$ " x 8 $\frac{1}{2}$ "	25 $\frac{3}{8}$ " x 17 $\frac{7}{8}$ " x 10 $\frac{1}{4}$ "	25 $\frac{3}{8}$ " x 17 $\frac{7}{8}$ " x 12"
FITS CAMDOLLY®	CD160	CD160	CD160
LIST PRICE EACH	\$ 348.00	\$ 359.00	\$ 391.00

Case Pack: 1 *UPCS160 Cannot be used with Camchiller.

Ultra Pan

One-piece, seamless polyethylene construction, airtight removable gasket and wide, nylon latches.



CODE	UPC140	UPC160	UPC180
COMPARTMENT CAPACITY	1 full size 4" deep pan	1 full size 6" deep pan	1 full size 8" deep pan
EXTERIOR DIM. W x D x H	24 $\frac{3}{4}$ " x 17 $\frac{7}{8}$ " x 8 $\frac{1}{2}$ "	24 $\frac{3}{4}$ " x 17 $\frac{7}{8}$ " x 10 $\frac{1}{4}$ "	24 $\frac{3}{4}$ " x 17 $\frac{7}{8}$ " x 12"
FITS CAMDOLLY	CD100H, CD1826HB, CD160	CD100H, CD1826HB, CD160	CD100H, CD1826HB, CD160
LIST PRICE EACH	\$ 535.00	\$ 540.00	\$ 560.00

Case Pack: 1

Multiple Stackable GN Food Pans, Top-Loading Carriers

100 Series

Store and stack food pans or place packaged food directly in compartment.



CODE	100MPC	UPC100
COMPARTMENT CAPACITY	3 full size 2 $\frac{1}{2}$ " deep pans or 2 full size 4" deep pans or 1 full size 6" or 8" deep pan	3 full size 2 $\frac{1}{2}$ " deep pans or 2 full size 4" deep pans or 1 full size 6" or 8" deep pan
EXTERIOR DIM. W x D x H	26 $\frac{3}{4}$ " x 18" x 15"	26 $\frac{3}{8}$ " x 18" x 15 $\frac{3}{4}$ "
INTERIOR DIM. W x D x H	21 $\frac{1}{4}$ " x 13 $\frac{3}{4}$ " x 8"	22 $\frac{1}{4}$ " x 13" x 8"
BULK CAPACITY*	40 qts.	40 qts.
FITS CAMDOLLY	CD100H, CD1826MTC, CD100HB, CD1826MTCHB, CD100, CD2028	CD100H, CD1826MTC, CD100HB, CD1826MTCHB, CD100, CD2028
LIST PRICE EACH	\$ 570.00	\$ 605.00

Case Pack: 1 *Without using food pans. 100MPC and UPC100 No Divider Bar.

Accessories

CODE	OVERALL EXTERIOR	LIST PRICE EA.
Divider Bars for Food Pans		
DIV12	12 $\frac{3}{4}$ " length	\$ 5.35
Case Pack: 3 Colors: White (148), Clear (135).		



TRANSPORTER CAPACITY GUIDE

Loading Examples for Cambro® Insulated Transporters

TOP LOADERS

UPC140-UPC180
UPCS140-UPCS180
UPCSS160

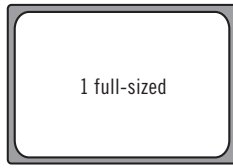

1 full-sized

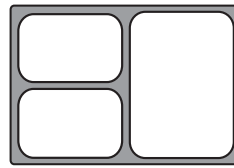

For a 3-course meal:
2 x GN 1/4
1 x GN 1/2
1 DIV12 divider bar
(approx. 14 meals)

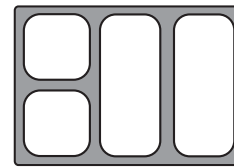

For a 4-course meal:
2 x GN 1/6
2 x GN 1/3
2 DIV12 divider bars
(approx. 14 meals)

TOP LOADERS

100 series
100MPC
UPC100

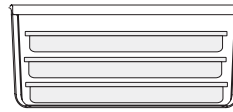

3 x 2 1/2" (6,5 cm)

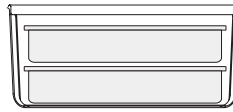

2 x 4" (10 cm)

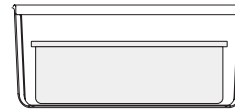

1 x 6" (15 cm)
or 1 x 8" (20 cm)



100MPCHL
or 1 x 8" (20 cm)

FRONT LOADERS

UPC300
1318CC
UPC600 (x2)
UPC1200 (x4)

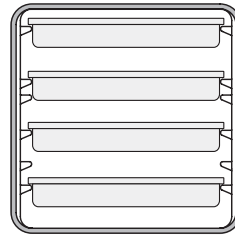

4 x 2 1/2" (6,5 cm)

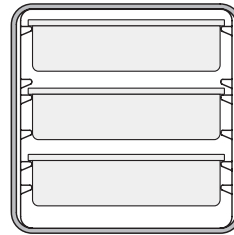

3 x 4" (10 cm)

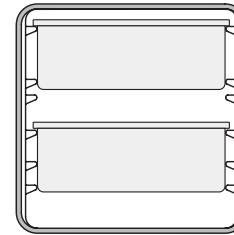

2 x 6" (15 cm)

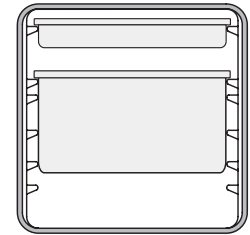

1 x 8" (20 cm)
and 1 x 2 1/2" (6,5 cm)

FRONT LOADERS

UPC400
UPCS400
UPCH400(2)
UPC800 (x2)
UPCH800(2) (x2)
UPC1600 (x4)
UPCH1600(2) (x4)

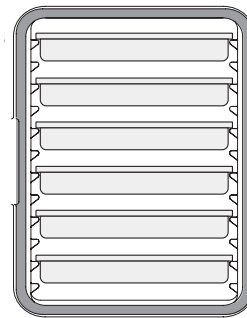

6 x 2 1/2" (6,5 cm)

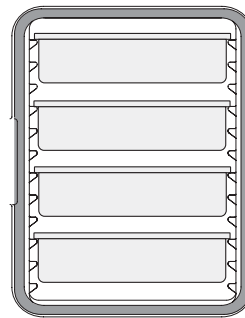

4 x 4" (10 cm)

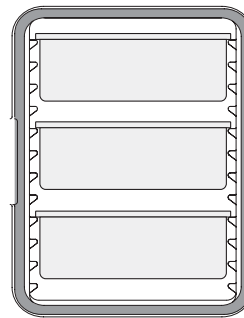

3 x 6" (15 cm)

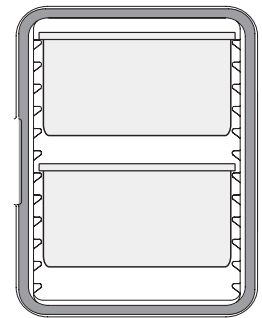

2 x 8" (20 cm)

CAMCARRIERS® AND CAMCARTS® FOR SHEET PANS

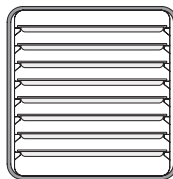

1318CC
1/2 size (x8)
sheet pans

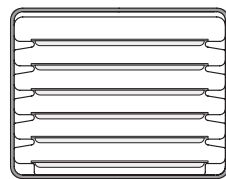

1826MTC
full-size (x6)
sheet pans
1826DTC (x4)

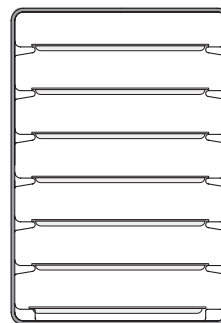

1826LTC3
full-size (x7)
sheet pans

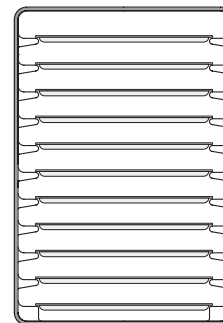

Camtherm Low
full-size (x11)
sheet pans
Camtherm Tall (x2)

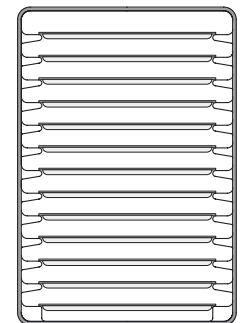

1826LTC
full-size (x13)
sheet pans

SUMMARY OF GN CONTAINER SIZES

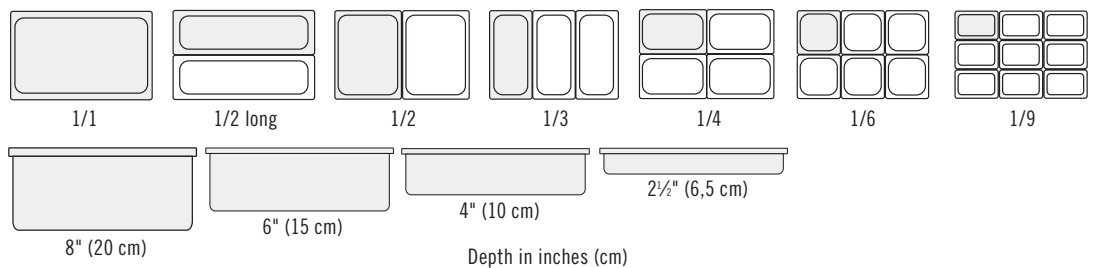

TEMPERATURE MAINTENANCE TOOLS



Camchiller®

- An easy-to-use, cold food holding temperature tool.
- Extend cold holding time or enhance safe holding below 41°F when frequent access is required.
- Freeze first then use to pre-chill cabinet before loading.



Cold — temperature gain averaging 1.5°F/hour.

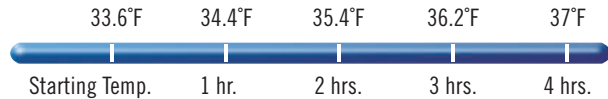

CODE	CP3253 GN Full Size	CP2632 GN Half Size	CP814 Camchiller 8 x 14
FITS INTO	Insulated Transporters: UPC300, 300MPC, 1318CC, 1318MTC, UPC400, UPSC400, UPC100, UPC600, UPC800, UPC1200, UPC1600, UPCCSS160 Camcruisers®: CVC72*, CVC724* Combo Carts™: All Models CamKiosk®*: All Models	Insulated Transporters: UPC300, 300MPC, 1318CC, 1318MTC, UPC140, UPC160, UPC180, UPC400, UPSC400, UPC600, UPC800, UPCCS140, UPCCS160, UPCCS180 Camcruisers®: CVC72*, CVC724* CamKiosk®*: All Models	Food Boxes: 12189CW, 12189P, 12186CW, 12186P Camcruisers®: CVC55, CVC72*, CVC724* CamKiosk®*: All Models
DIMENSIONS L x W x H	20.9" x 12.8" x 1.2"	12.8" x 10.4" x 1.2"	14" x 8" x 1½"
COLOR	Glacier Blue (443)	Glacier Blue (443)	Cold Blue (159)
LIST PRICE EACH	\$ 107.75	\$ 89.75	\$ 93.25

Case Pack: 1 InStock Color: Glacier Blue (443), Cold Blue (159). *Top wells only.

ThermoBarrier®

- Use to minimize empty space and food temperature loss within a partially loaded compartment.



CODE	UPC300DIV	300DIV	400DIV	1200DIV	1600DIV
FITS INTO	UPC300, 1318CC	300MPC, 1318MTC, UPC600	UPC400, UPC800, UPC400SP, UPSC400, UPC800SP	UPC1200, CVC72, CVC724	UPC1600, CamKiosk
DIMENSIONS L x W x H	20 ⁷ / ₈ " x 12 ¹⁵ / ₁₆ " x 1"	20 ¹³ / ₁₆ " x 12 ¹⁵ / ₁₆ " x 1"	21 ¹ / ₄ " x 13" x 1½"	20 ⁷ / ₈ " x 12 ⁷ / ₈ " x 1 ³ / ₈ "	20 ⁷ / ₈ " x 13 ³ / ₈ " x 1½"
COLOR	Charcoal Gray (615)	Coffee Beige (157)	Gray (180)	Dark Brown (131)	Slate Blue (401)
CASE PACK	1	1	1	2	2
LIST PRICE EACH	\$ 103.25	\$ 103.25	\$ 103.25	\$ 118.50	\$ 118.50

InStock Models: UPC300DIV and 400DIV.

Camwarmer®

- Added insurance to keep hot foods hot during holding and transporting.

- Keep in cabinet with hot foods to extend holding time or enhance safe holding above 140°F when frequent access is required.



CODE	1210PW	HP2632
FITS INTO	UPC300, 300MPC, 1318CC, 1318MTC, UPC400, UPSC400, UPC600, UPC800	UPC300, 300MPC, 1318CC, 1318MTC, UPC140, UPC160, UPC180, UPC400, UPSC400, UPC600, UPC800, UPCCS140, UPCCS160, UPCCS180
DIMENSIONS L x W x H	13 ³ / ₄ " x 10 ⁵ / ₈ " x 1 ¹ / ₁₆ "	12.8" x 10.4" x 1.2"
COLOR	Granite Gray (191)	Fire Red (444)
LIST PRICE EACH	\$ 259.00	\$ 78.00

Case Pack: 1 InStock Color: Granite Gray (191).



UPC400 with Camwarmer.

Two Camwarmers recommended per cavity. Place on bottom rail and store hot food above.

TEMPERATURE MAINTENANCE – OPTIMIZE FOOD HOLDING PERFORMANCE

Camchiller® – GN Full Size and Half Size

- Use to:
 - Pre-chill cabinet cavity.
 - Hold packaged food in food pan wells (Half Size Only).
 - Maximize cold food holding.
 - Minimize open cavity space.
- Easy to use:
 1. Freeze flat for 8 hours.
 2. Slide one or two on top rails and pre-chill cavity 15-20 minutes.
 3. Load in pans of pre-chilled food below Camchiller. (A)
 4. Move pans and Camchiller down as food is removed. (B)

COLD HOLDING

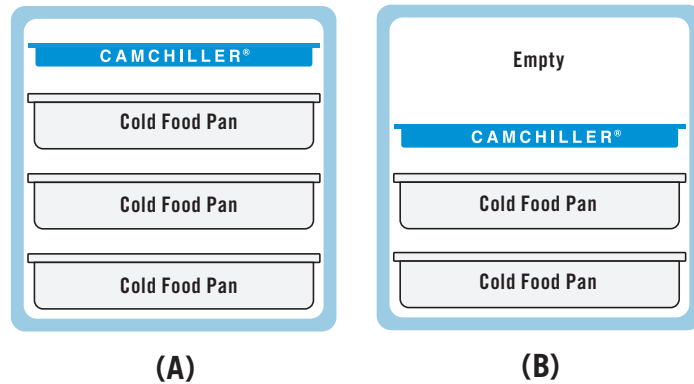

ThermoBarrier® – Full Size

- Use to:
 - Hold hot and cold food in same cabinet cavity.
 - Minimize open cavity space.
- Easy to use:
 1. Slide between hot food on top and cold food on bottom. (A)
 2. Slide under hot food loaded in upper cavity space. (B)
 3. Slide above cold food loaded into lower cavity space. (C)

HOT AND COLD HOLDING

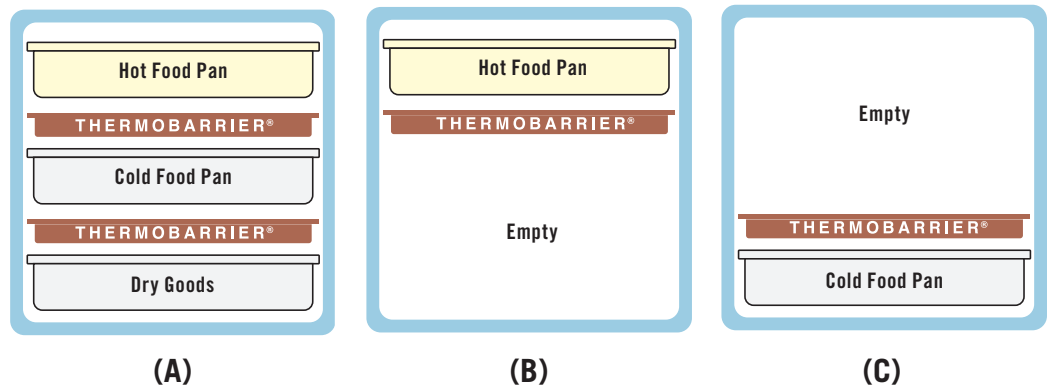

Camwarmer® – Half Size

- Use to:
 - Pre-heat cabinet cavity.
 - Maximize hot food holding.
 - Minimize open cavity space.
- Easy to use:
 1. Heat in 350°F oven for 45 min.
 2. Slide two Camwarmers on bottom rails and pre-heat cavity 15-20 minutes (or place on high heat food pan lid or sheet pan).
 3. Load in pans of pre-heated food above Camwarmers. (A)
 4. Move pans and Camwarmers up as food is removed. (B)

HOT HOLDING

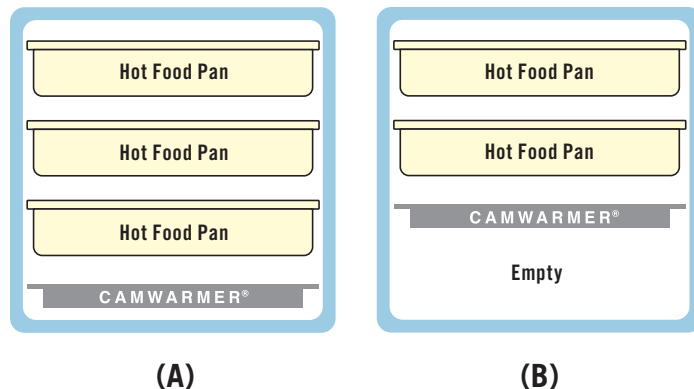

CAMDOLLIES® FOR INSULATED BEVERAGE SERVERS AND CARRIERS

With Handles



CD100H

EXTERNAL DIM. W x D x H:
19½" x 33⅝" x 36¼"

INTERIOR DIM. W x D:
17⅝" x 26⅜"

CAPACITY: 350 lbs.

CASTER TYPE: A

FITS: 250LCD, 350LCD, 500LCD, UC250, UC500, 100MPCHL, UPC140, UPC160, UPC180, 100MPC, 300MPC, UPC100, UPC300, UPCS140, UPCS160, UPCS180, UPCSS160

LIST PRICE EACH: \$ 700.00



CD300H

EXTERNAL DIM. W x D x H:
19" x 30½" x 36½"

INTERIOR DIM. W x D:
17" x 23½"

CAPACITY: 350 lbs.

CASTER TYPE: A

FITS: 1000LCD, UC1000, UPC300, 300MPC, 1318CC, 1318MTC, 250LCD, 350LCD, 500LCD, UC250, UC500, UPCS140, UPCS160, UPCS180, UPCSS160

LIST PRICE EACH: \$ 690.00



CD1826H

EXTERNAL DIM. W x D x H:
20" x 31½" x 38¼"

INTERIOR DIM. W x D:
18" x 26"

CAPACITY: 300 lbs.

CASTER TYPE: A

FITS: 250LCD, 350LCD, 500LCD, 1000LCD, UC250, UC500, UC1000, 100MPC, 300MPC, UPC300, UPCS140, UPCS160, UPCS180, UPCSS160

LIST PRICE EACH: \$ 745.00



CD1826MTC

EXTERNAL DIM. W x D x H:
23⅝" x 35⅝" x 36⅜"

INTERIOR DIM. W x D:
21⅝" x 28⅜"

CAPACITY: 350 lbs.

CASTER TYPE: A

FITS: 100MPC, UPC100, 1826MTC

LIST PRICE EACH: \$ 795.00



CD2020H

EXTERNAL DIM. W x D x H:
22⅝" x 25⅝" x 36⅝"

INTERIOR DIM. W x D:
20⅝" x 20⅝"

CAPACITY: 350 lbs.

CASTER TYPE: B

FITS: 250LCD, 350LCD, 500LCD, 1000LCD, UC1000

LIST PRICE EACH: \$ 630.00



Big Rear Wheels



CD100HB

EXTERNAL DIM. W x D x H:
23⅝" x 32⅝" x 36⅝"

INTERIOR DIM. W x D:
18" x 27"

CAPACITY: 350 lbs.

CASTER TYPE: C

FITS: 250LCD, 350LCD, 500LCD, 1000LCD, UC250, UC500, UC1000, 100MPCHL, 100MPC, UPC100, UPC300, 300MPC

LIST PRICE EACH: \$ 850.00



CD300HB

EXTERNAL DIM. W x D x H:
23½" x 29⅝" x 36½"

INTERIOR DIM. W x D:
17" x 23⅝"

CAPACITY: 350 lbs.

CASTER TYPE: C

FITS: 250LCD, 350LCD, 500LCD, 1000LCD, UC250, UC500, UC1000, 300MPC, 1318MTC, UPC300, 1318CC, UPCS140, UPCS160, UPCS180, UPCSS160

LIST PRICE EACH: \$ 815.00



CD1826HB

EXTERNAL DIM. W x D x H:
23½" x 32½" x 36½"

INTERIOR DIM. W x D:
18½" x 26¼"

CAPACITY: 300 lbs.

CASTER TYPE: C

FITS: 250LCD, 350LCD, 500LCD, UPC140, UPC160, UPC180, 300MPC, 1318MTC, UPC300, 1318CC, UPCS140, UPCS160, UPCS180, UPCSS160

LIST PRICE EACH: \$ 920.00



CD1826MTCHB

EXTERNAL DIM. W x D x H:
27⅝" x 35" x 36¾"

INTERIOR DIM. W x D:
21⅝" x 28⅝"

CAPACITY: 350 lbs.

CASTER TYPE: C

FITS: 1000LCD, UC1000, 100MPC, UPC100, 1826MTC

LIST PRICE EACH: \$ 1,015.00



CD2020HB

EXTERNAL DIM. W x D x H:
26¼" x 26½" x 36⅝"

INTERIOR DIM. W x D:
20½" x 20⅝"

CAPACITY: 350 lbs.

CASTER TYPE: C

FITS: 250LCD, 350LCD, 500LCD

LIST PRICE EACH: \$ 815.00



CAMDOLLIES® FOR INSULATED BEVERAGE SERVERS AND CARRIERS

Without Handles



CD100

EXTERNAL DIM. W x D x H:
19⁵/₈" x 28⁵/₈" x 10¹/₂"

INTERIOR DIM. W x D:
17³/₁₆" x 26³/₈"

CAPACITY: 300 lbs.

CASTER TYPE: A

FITS: 250LCD, 350LCD, 500LCD, UC250, UC500, 100MPCHL, 100MPC, 300MPC, UPC300, UPC100, UPCS140, UPCS160, UPCS180, UPCSS160

LIST PRICE EACH: \$ 429.00



CD160

EXTERNAL DIM. W x D x H:
16⁷/₁₆" x 24¹/₂" x 10³/₈"

INTERIOR DIM. W x D:
14¹/₄" x 22¹/₄"

CAPACITY: 300 lbs.

CASTER TYPE: A

FITS: UPCS140, UPCS160, UPCS180, UPCSS160, UPC140, UPC160, UPC180

LIST PRICE EACH: \$ 429.00



CD300

EXTERNAL DIM. W x D x H:
25¹/₂" x 19¹/₄" x 10¹/₂"

INTERIOR DIM. W x D:
16⁷/₈" x 23¹/₁₆"

CAPACITY: 350 lbs.

CASTER TYPE: A

FITS: 1000LCD, UC1000, 300MPC, 1318MTC, UPC300, 1318CC, UPCS140, UPCS160, UPCS180, UPCSS160

LIST PRICE EACH: \$ 429.00



CD400

EXTERNAL DIM. W x D x H:
21¹/₁₆" x 28³/₈" x 9"

INTERIOR DIM. W x D:
18¹/₂" x 25⁵/₁₆"

CAPACITY: 300 lbs.

CASTER TYPE: A

FITS: UPCS400, UPC400

LIST PRICE EACH: \$ 478.00



CDC300

EXTERNAL DIM. W x D x H:
17¹/₁₆" x 24⁷/₈" x 7³/₁₆"

INTERIOR DIM. W x D:
17¹/₁₆" x 24³/₈"

CAPACITY: 300 lbs.

CASTER TYPE: D

FITS: EPP400, EPP300, UPC300, EPP180SW, EPP160SW

LIST PRICE EACH: \$ 238.00



CDC400

EXTERNAL DIM. W x D x H:
18¹⁵/₃₂" x 25¹/₄" x 6⁷/₈"

INTERIOR DIM. W x D:
18¹/₂" x 25"

CAPACITY: 300 lbs.

CASTER TYPE: D

FITS: UPC400, EPP180XLTSW

LIST PRICE EACH: \$ 270.00



CD1420

EXTERNAL DIM. W x D x H:
16¹/₄" x 21³/₄" x 8⁵/₁₆"

INTERIOR DIM. W x D:
13³/₈" x 19¹/₁₆"

CAPACITY: 350 lbs.

CASTER TYPE: B

FITS: 100LCD

LIST PRICE EACH: \$ 397.00



CD2020

EXTERNAL DIM. W x D x H:
22¹/₂" x 22¹/₂" x 8¹/₄"

INTERIOR DIM. W x D:
20³/₈" x 20¹/₈"

CAPACITY: 300 lbs.

CASTER TYPE: B

FITS: 250LCD, 350LCD, 500LCD, 1000LCD, UC1000

LIST PRICE EACH: \$ 402.00



CD2028

EXTERNAL DIM. W x D x H:
21¹/₈" x 30¹/₄" x 8¹/₄"

INTERIOR DIM. W x D:
19¹/₂" x 27¹/₈"

CAPACITY: 350 lbs.

CASTER TYPE: B

FITS: 100MPC, UPC100, 300MPC, UPC300, UPC400

LIST PRICE EACH: \$ 413.00



Camdolly® Colors:

Coffee Beige (157), Dark Brown (131), Black (110), Slate Blue (401).

CDC300 and CDC400 Color: Red (358).

CD400 InStock Colors:

Black (110), Dark Brown (131).

Caster Type:

(A) 5" Casters, 2 fixed, 2 swivel, 1 with brake.

(B) 3" Casters, 4 swivel, no brakes.

(C) 10" Rear Big Wheels, 2 front 5" swivel casters, 1 with brake.

(D) 4" Casters, 4 swivel 2 with brake.

Optional Accessories



400STP (STRAP)

DIMENSION: 150" Long

LIST PRICE EACH: \$ 29.70

UTHSTP (STRAP)

DIMENSION: 200" long

LIST PRICE EACH: \$ 30.00



1826HAR (LIFTING HARNESS)

DIMENSION: 142" long

LIST PRICE EACH: \$ 138.80



Insulated Beverage Servers

- Use to hold, transport and serve hot or cold beverages for up to 4 hours.
- Pre-heat or pre-chill before use to guarantee maximum operational efficiency.
- Sturdy latches secure lids tightly and will never rust.
- Drip-proof recessed spigot for easy self-serve access.
- Molded-in metal backing plates prevents latches from breaking away from the container.

INSULATED BEVERAGE SERVERS

Insulated Beverage Servers

- Stack units on riser to fill large cups or coffee pots.
- Stack interlocking ensures stable stacking during transport and storage.

UC1000 covered by U.S. Patent D 403,916.



Stacking options:

- 100LCD with 100LCD
- All 250, 350 and 500 units
- UC1000 and 1000LCD

Hot — temperature loss averaging 3°F/hour.

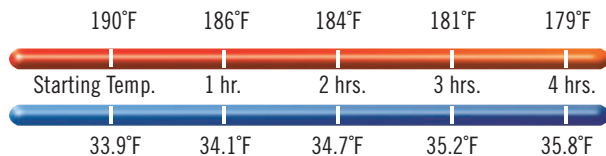

Cold — temperature gain averaging 1.5°F/hour.



Camtainer Cover

Durable and attractive covers dress up and extend the life of your Camtainers.

Personalization available: \$10.00 net per cover. Contact your Cambro representative for more details. (Models for covers on next page.)



Vent Cap

Equalizes pressure. Makes opening the container much easier.



Recessed Faucet

Accommodates larger cups. Allows even dispensing and eliminates drips. Two positions: One for continuous pouring and one for individual dispensing.



Molded-in Metal Backing Plates

Prevents latches from breaking away from the container.



Ultra Camtainers®

Feature wide nylon latches which are easy to open and close with one hand.



Camtainers®

Feature sturdy plastic latches that secure lids tightly and will never rust.

INSULATED BEVERAGE SERVERS



Gamtainers®

The standard for many caterers. Four sturdy plastic latches on each unit open and close easily and will never rust.



CODE	100LCD	250LCD	500LCD	1000LCD	350LCD Soup
CAPACITY	1½ gal.	2½ gal.	4¾ gal.	11¾ gal.	3¾ gal.
7 OZ. CUPS	27	45	86	214	61
SPIGOT	YES	YES	YES	YES	—
EXTERIOR DIM. W x D x H	10¾" x 11½" x 17¼"	9" x 16½" x 18¾"	9" x 16½" x 24¼"	16¼" x 20¾" x 24¾"	9" x 16½" x 18¾"
FITS CAMDOLLY®	CD1420	CD100H, CD1826H, CD300H, CD2020H, CD100HB, CD300HB, CD1826HB, CD2020HB, CD100, CD2020	CD100H, CD1826H, CD300H, CD2020H, CD100HB, CD300HB, CD1826HB, CD2020HB, CD100, CD2020	CD300H, CD1826H, CD2020H, CD100HB, CD300HB, CD1826MTCHB, CD300, CD2020	CD100H, CD1826H, CD300H, CD2020H, CD100HB, CD300HB, CD1826HB, CD2020HB, CD100, CD2020
LIST PRICE EACH	\$ 309.00	\$ 322.00	\$ 364.00	\$ 570.00	\$ 314.00
CAMTAINER COVER	—	250LDCVR: \$ 156.00	500LDCVR: \$ 156.00	1000LDCVR: \$ 156.00	—

Case Pack: 1 Colors: Navy Blue (186), Slate Blue (401), Coffee Beige (157), Dark Brown (131), Brick Red (402), Kentucky Green (519), Black (110), Hot Red (158).
InStock Colors: Dark Brown (131), Black (110). **Cover Color:** Black (110). Venting plug is covered by US Patent D 553,717 S.

Ultra Camtainers®

A contemporary line, featuring two wide nylon latches per unit that are easy to open and close.



CODE	UC250	UC500	UC1000
CAPACITY	2¾ gal.	5¼ gal.	10½ gal.
7 OZ. CUPS	50	96	192
EXTERIOR DIM. W x D x H	11¾" x 16¾" x 19¾"	11¾" x 16¾" x 26¾"	16¼" x 20½" x 25¾"
FITS CAMDOLLY	CD100H, CD1826H, CD300H, CD100HB, CD300HB, CD100	CD100H, CD1826H, CD300H, CD100HB, CD300HB, CD100	CD300H, CD1826H, CD2020H, CD100HB, CD300HB, CD1826MTCHB, CD300, CD2020
LIST PRICE EACH	\$ 380.00	\$ 429.00	\$ 590.00
CAMTAINER COVER	UC250CVR: \$ 156.00	UC500CVR: \$ 156.00	UC1000CVR: \$ 156.00

Case Pack: 1 Colors: Navy Blue (186), Slate Blue (401), Coffee Beige (157), Dark Brown (131), Brick Red (402), Kentucky Green (519), Black (110), Granite Gray (191), Granite Green (192), Granite Sand (194). **InStock Colors:** Dark Brown (131), Black (110), Granite Gray (191). Venting plug is covered by US Patent D 553,717 S.
Cover Color: Black (110).

Camserver®

- A front-of-house beverage server for hot or cold beverages that does not require canned heating.
- Double-wall polyethylene shell with thick foam insulation retains temperatures for hours.

Colors: Black (110), Dark Taupe (417), Granite Gray (191).



CSR3
Shown in
Dark Taupe.



CSR5
Shown in Black.

Height is approximately 7"
from counter to spigot.



Convenient top-fill opening for fast replenishment without removing lid.

CODE	OVERALL DIMENSIONS W x D x H	CAPACITY	7 OZ. CUPS	LIST PRICE EA.
CSR3	13¾" x 18¾" x 23½"	3 gal.	54	\$ 670.00
CSR5	13¾" x 18¾" x 28"	5	91	695.00

Case Pack: 1



BEVERAGE SERVICE CARTS

- Ideal for breakfast, coffee or snack service.
- Use top counter to hold Cambro Beverage Servers, Versa Organizer Bins or Display Trays with Covers for food.
- Store drinkware, additional food items or other supplies in open compartment.
- Insulated cabinets hold hot or cold food in 1/1, 1/2 or 1/3 size food pans or on Cambro Metric Camtrays® (3253).

Colors: Slate Blue (401), Granite Gray (191), Granite Green (192).

See Organizer section for more information on Organizer Bins.

See Beverage Server section for more information.

Wire Rack Color: Silver (000).

6" Casters: 2 fixed, 2 swivel, 1 with brake.



Beverage Service Cart is designed to hold Beverage Containers at point of service only. A dolly or hand truck with safety strap is recommended for moving Beverage Containers over longer distances or uneven surfaces.



MDC24F
Shown in Granite Gray (191).

CODE	EXTERIOR DIM. L x W x H	CASE PACK	LIST PRICE EA.
MDC24F	44½" x 30" x 44"	1	\$ 3,410.00
MDC24	44½" x 30" x 44"	1	3,410.00
OPTIONAL ACCESSORIES			
Organizer Bin			
5412CBP	12" x 5" x 4¼"	12	13.15
Camtainer®			
100LCD	10¾" x 11¾" x 17¼"	1	309.00
Wire Rack			
MDC24R	23" x 17" x 14"	1	366.70
Camchiller®			
CP3253	20 ¹³ / ₁₆ " x 12 ⁷ / ₈ " x 11 ¹ / ₂ "	1	107.75

The use of racks in the MDC24 and MDC24F carts will allow the following configuration of pans or trays, per compartment:

DESCRIPTION	FULL (1/1)	HALF (1/2)	THIRD (1/3)
2½" Pans	(4) 12CW	(8) 22CW	(12) 32CW
4" Pans	(3) 14CW	(6) 24CW	(9) 34CW
6" Pans	(2) 16CW	(4) 26CW	(6) 36CW
8" Pans	(1) 18CW*	(2) 28CW*	(3) 38CW*
Metric Camtrays®	(10) 3253	—	—

*With room for 2½" or 4" pan above 8" pan.

Compartment Dimensions:

Shelf Compartment:	W 37 ¹⁵ / ₁₆ "	D 25 ¹ / ₈ "	H 10"
Holding Compartments:	W 17 ⁷ / ₁₆ "	D 23 ³ / ₈ "	H 14 ¹ / ₈ "

Venting plug is covered by U.S. Patent D 553,717S.



MDC24, shown in Granite Green (192), has recessed top that holds 3 each 1 gallon Camtainers and stacked Condiment Bins & Wire Rack with 3253 trays.



MDC24R Wire Rack

Wire Rack (sold separately) to organize pans and trays in the cart. Rack holds 1/1, 1/2 and 1/3 size Food Pans and 3253 trays. When placed in cart's holding compartment, the rack allows room on either side for CP3253 Camchillers®.

INSULATED BEVERAGE SERVER ACCESSORIES

Handwash Accessories

- Convenient and economical way to meet health department hand washing requirements on or off premise.
- Attaches to 2.5-gallon (9.5 L) or 5-gallon (19 L) Camtainers® or Ultra Camtainers®.
- Includes four "Handwash Only" labels and an Easy Serve Dispenser lever.

Handwash Accessory Stocking Colors:
Dark Brown (131), Black (110).

Easy Serve Dispenser Color:
Black (110).

Riser Colors: See optional accessories with Camtainers.

Pail with Bail Color: White (148).

Handwash Accessory is covered by the following U.S. Patents: D 506,634 S, D 506,899 S & D 548, 980 S.



CODE	HWAPR	HWATD
DESCRIPTION	With paper towel roll holder	With multi-fold paper towel dispenser
FITS	250LCD, 500LCD, UC250, UC500	250LCD, 500LCD, UC250, UC500
LIST PRICE EACH	\$ 369.00	\$ 483.00



Shown with 500LCD Camtainer.

Optional Handwash Accessories

CODE	DESCRIPTION	LIST PRICE EA.
R500LCD	Riser	\$ 131.50
PWB22	Pail with Bail	35.75
LCDES	Easy serve dispenser	25.40

R500LCD, PWB22, LCDES are NSF listed.

Optional Accessories

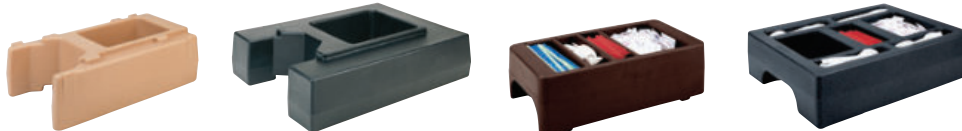

CODE	R500LCD	R1000LCD	LCDC	LCDC10	LCDES
DESCRIPTION	Riser	Riser	Condiment holder	Condiment holder	Easy serve dispenser
EXTERIOR DIM. W x D x H	9 7/8" x 16 1/4" x 4 3/16"	15 3/8" x 19 1/2" x 4 1/2"	8 3/4" x 16 1/2" x 5"	16" x 20" x 4 13/16"	—
FITS	250LCD, 500LCD, UC250, UC500	1000LCD, UC1000	250LCD, 500LCD, UC250, UC500	1000LCD, UC1000	LCD spigots, UC spigots
LIST PRICE EACH	\$ 131.50	\$ 145.50	\$ 118.50	\$ 174.00	\$ 25.40

Case Pack: 1 Colors: Coffee Beige (157), Dark Brown (131), Black (110). Easy Serve Dispenser Color: Black (110).

MOBILE HANDWASH STATION

Approx.

200

handwashings
per tank



Completely Hands-Free Operation



Requires

NO plumbing or electricity

to operate.

MHWS18

21.1" x 19" x 63.6"

LIST PRICE EACH: \$ 2,140.00

MHWS18PER100 (with graphics wrap)

LIST PRICE EACH: \$ 2,485.00



MOBILE HANDWASH STATION



3-IN-1 HANDWASHING STATION

Paper towel and
soap dispenser

5 Gallon Camtainer® with
Easy Serve Dispenser

Riser

HWS31

LIST PRICE EACH: \$ 880.00

MORE
INFC 



HAND SINK CART

With electric water pump and heater

KSC402

40 9/16" x 33" x 45 1/2"

LIST PRICE EACH: \$ 7,475.00

MORE
INFC 

CVC75 MOBILE FOOD VENDING CART



with
Safety-First Design

Versatile and durable mobile solution provides maximum menu flexibility, indoors and outdoors.





CVC75 MOBILE FOOD VENDING CART

Requires
minimum
← 33⁵/₈" →
Doorway

3 Open Storage Compartments

Perfect for restock in Cambro EPP GoBoxes



Open well design — configure your ingredients and menu items for peak serving efficiency



Add optional levels to the standard 12" Safety Barrier increase merchandising space and operator safety



End Table available facilitate a fast service

All Weather Vinyl Wrap



* All CVC75 carts come with a vinyl wrap

 **Build Your Own Cart**

Let's Get Personal!

Whether it's your logo on one of our standard wraps or a fresh new design, wrap customization is available - consult your local Cambro representative



CVC75 MOBILE FOOD VENDING CART



Dimensions and Product Codes

CODE	DESCRIPTION	OVERALL EXTERIOR DIMENSIONS L x W x H	FULL PAN SIZE CAPACITY	LIST PRICE EACH
CVC75	Vending base unit with safety barrier	75" x 33½" x 53½"	5	\$ 9,620.00
CVC75B	Vending base unit only	75" x 33½" x 37¾"	5	6,520.00
Optional Accessories*				
CVC75DC6	6" tall merchandising display	—	—	820.00
CVC75DC12	12" tall merchandising display	—	—	1,000.00
CVC75DCE6	6" tall merchandising display extender	—	—	790.00
CVC75DCE12	12" tall merchandising display extender	—	—	940.00
CVC75LET	16" left side end table	—	—	810.00
CVC75RET	16" right side end table	—	—	810.00
CVC75LSRL	Set of two adjustable lower cabinet shelves	—	—	760.00

Case Pack: 1 **Color:** Black (110). *All accessories only available in Black (110).

CAMKIOSK® SYSTEM — EVERY EVENT OR LOCATION IS AN OPPORTUNITY FOR PROFITS



- Build sales off premise and in non-traditional locations.
- Two insulated food storage cabinets maintain safe hot or cold food and/or beverage temperatures for hours.
- Use optional well covers to cover food pan wells and increase countertop space.
- Durable, all-weather polyethylene exterior with foam insulation will not crack, dent, bubble, chip, rust or break.
- Heavy duty 6" (15,2 cm) casters roll smoothly from kitchen to location then lock in place.

CAMKIOSK® CARTS



Telescoping poles enable canopy to lower 12" for quick and easy storage.



KVC854C Cart with 4 pan wells & canopy.



Camchillers® keep packaged foods cold during transport and service. Place directly on top of food pan wells or at the top of the CamKiosk insulated holding cabinet.

Cart Colors Canopy Color

186	Navy Blue	157	Beige
158	Hot Red		

Cart Colors Canopy Color

191	Granite Gray	519	Kentucky Green
192	Granite Green		
519	Kentucky Green		
426	Black Base with Granite Gray Top & Doors		

Personalize your CamKiosk Cart to promote your brand.

Canopy Trim and Top Panel

Call 714-230-4125 for a quote.

Front Display Panel

(Cruising Café® panel standard)

Set Up Charge per Panel \$ 135.00

Charge NET per Color 10.00



4 well top with work space.



6 well top.

Holding Capacity Per Compartment

Two holding cabinets store hot or cold food in Gastronorm Food Pans with Covers.

12 GN 1/1 full size 2½" deep pans or
8 GN 1/1 full size 4" deep pans or
6 GN 1/1 full size 6" deep pans or
4 GN 1/1 full size 8" deep pans or
4 each 2025 Camtrays® or
8 each 3253 Camtrays.

CODE	FULL SIZE PAN WELLS	OVERALL DIMENSIONS L x W x H	LIST PRICE EA.
CamKiosk Carts			
KVC854	4	85½" x 33½" x 70½"	\$ 10,135.00
KVC854C	4	85½" x 33½" x 94"	13,830.00
KVC856	6	85½" x 33½" x 70½"	10,135.00
KVC856C	6	85½" x 33½" x 94"	13,830.00

C: Canopy

Well Cover Colors: Black (110), Hot Red (158), Navy Blue (186), Kentucky Green (519), Granite Gray (191), Granite Green (192).

6" Casters: 2 swivel, 2 swivel with brake.

Cutting Board Color: White (148).

Camchiller Color: Glacier Blue (433).

ThermoBarrier Color: Slate Blue (401).

CODE	DESCRIPTION	DIMENSIONS L x W x H	CASE PACK	LIST PRICE EA.
Optional Accessories				
CB1220	Cutting board	21" x 13½" x ½"	1	\$ 69.80
CP814	8" x 14" Camchiller	1½" x 8" x 14"	1	93.25
CP2632	Camchiller GN 1/2	12.8" x 10.4" x 1.2"	1	89.75
CP3253	Camchiller GN 1/1	20.9" x 12.8" x 1.2"	1	107.75
WCR1220	Well cover	21" x 13" x 2"	1	138.00
1600DIV	ThermoBarrier® insulated shelf	20⅞" x 13⅞" x 1½"	2	118.50



Camchiller & ThermoBarrier

CAMKIOSK® HAND SINK CART, WORK STATION & EQUIPMENT STAND

Hand Sink Cart

- Self-contained, electric hand washing system can be used alone or with CamKiosk Cart.
- Run hot and cold water for up to 70 hand washings.
- Includes: double sink, two 5-gallon (19 L) fresh water tanks, two 7½-gallon (28,5 L) waste-water bins, hand soap dispenser and paper towel roll holder.
- Durable polyethylene will not crack, dent, bubble, chip or break.
- Hand Sink Cart is designed for hand washing. It contains no filter for purifying water for drinking.
- Faucet is compliant with lead-free regulations.

Colors: Granite Gray (191), Granite Green (192), Navy Blue (186), Hot Red (158), Kentucky Green (519), Black Base with Granite Gray Top & Doors (426).

6" Casters: 2 fixed, 2 swivel with brake.

Hand Sink Cart is covered by U.S. Patent 6,173,458 B1.



Water heater and water pump draw a maximum of 11.25 amps and 0.7 amps, respectively. Hand Sink Cart electrical system runs on an average 10 amps.

ADA faucet available. Contact Cambro Customer Service for information.

CODE	VOLTAGE	DIMENSIONS L x W x H	LIST PRICE EA.
KSC402	110	40 ⁹ / ₁₆ " x 33" x 45 ¹ / ₂ "	\$ 7,475.00

Case Pack: 1

Work Station

- Use to merchandise menu items, additional work space or to complete sales transactions.
- Large storage cabinet below is perfect for holding supplies.
- Extremely durable all-weather polyethylene will not crack, dent, bubble, chip, rust or break.

Colors: Granite Gray (191), Granite Green (192), Navy Blue (186), Hot Red (158), Kentucky Green (519), Black Base with Granite Gray Top & Doors (426).

6" Casters: 2 fixed, 2 swivel with brake.

Top work area dimensions: 22¹/₂" x 26"



Shown with optional cutting board and paper towel roll dispenser.

CODE	DESCRIPTION	DIMENSIONS L x W x H	LIST PRICE EA.
KWS40	Work station	40 ⁹ / ₁₆ " x 33" x 45 ¹ / ₂ "	\$ 3,535.00
CB1220	Cutting board	21" x 13 ⁷ / ₈ " x 1 ¹ / ₂ "	69.80

Case Pack: 1

Equipment Stand

- Perfect for self-serve stations, prep areas or cash register service.
- Counter and side openings for electrical cords and cables.
- Tray rails fold down for convenient transportation and storage.
- Durable, lightweight polyethylene will not crack, dent, bubble, chip, rust or break.
- No assembly required.

Color: Black (110).

5" Casters: 2 fixed, 2 swivel with brake.

*Special order item not carried in stock, non-returnable.







Cutaway chair area gives ample space for comfortable seating.

CODE	DESCRIPTION	OVERALL DIMENSIONS W (W/TRAY RAILS) x D x H	LIST PRICE EA.
ES28	Stand only	28" x 28" x 39"	\$ 1,800.00
ES28RL*	Stand w/rails on right and left sides of drawer	44" x 28" x 39"	2,390.00

Height includes casters.

CAMCRUISER® VENDING CARTS

- Add revenue opportunities away from the kitchen or cafeteria and reduce wait times.
- Durable polyethylene will not crack, dent, bubble, chip, rust or break.
- Display panel can be personalized with a custom logo or message.
- Larger models CVC724 & CVC72 have insulated food storage compartments and full-size food pan wells.
- Compact model CVC55 has two open storage compartments, a single food pan well, cutting board and umbrella.

Cart Colors	Umbrella Colors
Black (110)	
Hot Red (158)	
Kentucky Green (519)	
Granite Gray (191)	
Granite Green (192)	



CVC724

OPEN COMPARTMENT DIMENSIONS:
 W 13 $\frac{1}{8}$ " x D 24 $\frac{1}{4}$ " x H 13 $\frac{3}{4}$ "
 W 33,5 x D 61,5 x H 34 cm

CVC724 & CVC72



CVC724 has four full size food pan wells. Fill with cutting boards or well covers to create additional work space.



CVC72 Has one full size food pan well and two larger merchandising wells.



Open holding compartment conveniently stores cash box and tray.



Place one or two half size Camchillers® directly on top of food pan well to hold cold packaged foods cold.



CVC72

CODE	CVC724	CVC72	CVC55
OVERALL DIMENSION*	L 74 $\frac{1}{2}$ " x W 31 $\frac{3}{4}$ " x H 94"	L 74 $\frac{1}{2}$ " x W 31 $\frac{3}{4}$ " x H 94"	L 55 $\frac{1}{16}$ " x W 31 $\frac{1}{4}$ " x H 93 $\frac{1}{2}$ "
WORK COUNTER HEIGHT	36 $\frac{1}{2}$ "	36 $\frac{1}{2}$ "	39 $\frac{3}{4}$ "
COUNTER WELLS HOLD	4 full size pans, 6" deep	Center well, 1 full size pan, 6" deep 2 outer wells, L 22 $\frac{1}{2}$ " x W 15 $\frac{3}{8}$ " x D 6"	1 full size pan, 8" deep
CLOSED COMPARTMENT CAPACITY (EACH)	2 full size 8" + 2 full size 2 $\frac{1}{2}$ " deep pans or 4 full size 6" deep pans or 6 full size 4" deep pans or 8 full size 2 $\frac{1}{2}$ " deep pans or 4 each 2025 Camtrays® or 8 each 3253 Camtrays	2 full size 8" + 2 full size 2 $\frac{1}{2}$ " deep pans or 4 full size 6" deep pans or 6 full size 4" deep pans or 8 full size 2 $\frac{1}{2}$ " deep pans or 4 each 2025 Camtrays or 8 each 3253 Camtrays	—
OPEN COMPARTMENT CAPACITY	1 cash drawer and 1 full size 6" deep pan or 2 full size 4" deep pans or 3 full size 2 $\frac{1}{2}$ " deep pans	1 cash drawer and 1 full size 6" deep pan or 2 full size 4" deep pans or 3 full size 2 $\frac{1}{2}$ " deep pans	—
UMBRELLA DIAMETER	72" (183 cm)	72" (183 cm)	60" (152 cm)
CASTERS	8" – 4 swivel with brake	8" – 4 swivel with brake	6" – 2 fixed, 2 swivel with brake
CASH DRAWER	Yes	Yes	—
MENU BOARD	Yes	Yes	—
DISPLAY PANEL	Yes	Yes	Yes
MOLDED IN HANDLES	2	2	1
LIST PRICE EACH	\$ 8,270.00	\$ 8,270.00	\$ 4,955.00

*Includes Umbrella. Serving counter height is 51".

CAMCRUISER® VENDING CARTS



CVC55

Cutting Board Color: White (148).
Camchiller® Color: Glacier Blue (443).
Divider Bar Colors: White (148), Clear (135).
Retainer Strap Color: Black (110).
ThermoBarrier® Color: Dark Brown (131).

ThermoBarrier, Camchillers and Divider Bar are NSF Listed.
 Well Cover Color matches cart.
 CVC55 is covered by U.S. Patent D 362,102.



LEFT COMPARTMENT DIMENSIONS:
 W 24½" x D 28½" x H 27½"

RIGHT COMPARTMENT DIMENSIONS:
 W 21½" x D 28½" x H 27½"

- Compartments are open for storage and easy access to equipment and supplies for your vending operations. Optional retainer strap is sold separately.
- Display panel can be personalized.



Personalize your Camcruiser Cart to promote your brand.

Front Display Panel
 "Campus Cuisine" display panel standard on CVC724 & CVC72. Striped panel standard on CVC55.

Set Up Charge per Panel \$ 135.00 (Net)
 Charge per Color 10.00 (Net)



Sandwich Camcruiser

Pizza Camcruiser



Hot Dog Camcruiser

Soft Drink Camcruiser

CVC55



Set up with full or fractional size food pans and divider bars to increase product offerings.



Electrical or soda line conveniently drops through 4" x 6¼" opening in counter. Cover is standard with cart.

CODE	DESCRIPTION	FITS	OVERALL DIM. L x W x H	LIST PRICE EA.
Optional Accessories				
CB1220	Cutting board	CVC724, CVC72, CVC55	21" x 13½" x ½"	\$ 69.80
1200DIV	ThermoBarrier	CVC724, CVC72	20⅞" x 13⅞" x 1⅜"	118.50
CP3253	1/1 GN Camchiller	CVC724, CVC72	20.9" x 12.8" x 1.2"	107.75
CP2632	1/2 GN Camchiller	CVC724, CVC72	12.8" x 10.4" x 1.2"	89.75
CP814	Camchiller	CVC72, CVC724	14" x 8" x 1½"	93.25
DIV12	Divider bar	CVC724, CVC72, CVC55	Well only	5.35
WCR1220	Well cover	CVC724, CVC72, CVC55	21" x 13" x 2"	138.00
730STP	Retainer strap	CVC55	—	39.80

DIV12 Case Pack: 3 1200DIV Case Pack: 2 730STP Retainer Strap Case Pack: 2 All Others Case Pack: 1

CAMSHELVING PREMIUM® SERIES FLEX STATION SYSTEM

Grab-N-Go solution for K-12 schools



Promote healthy eating habits

Setup anywhere in school

Reduces serving time

CPM244867FX1

CAMSHELVING PREMIUM® SERIES FLEX STATION SYSTEM

Ideal for takeout, delivery or curbside staging needs



CPM244867FX2

Customize as needed for holding or
storing inside or outside

CAMSHELVING PREMIUM® SERIES FLEX STATIONS



CPM244867FX3 (67" H)
CPM244875FX4 (75" H)

CPM244875FX5

MERCHANDISERS



CODE	DESCRIPTION	DIMENSIONS D x L x H	CASE PACK	LIST PRICE EA.
Premium® Series Flex Stations				
CPM244867FX1	4 Tiers with Angled Divider Bars	24" x 48" x 67"	1	\$ 1,330.00
CPM244867FX2	1 Solid Shelf, 3 Tiers with Angled Divider Bars	24" x 48" x 67"	1	1,565.00
CPM244867FX3	4 Solid Shelves with Divider Panels	24" x 48" x 67"	1	1,875.00
CPM244875FX4	4 Solid Shelves with Divider Panels	24" x 48" x 75"	1	1,885.00
CPM244875FX5	2 Solid Shelves, 3 Tiers with Angled Divider Bars	24" x 48" x 75"	1	1,835.00
Merchandiser Kits				
CSFLEXMERCH	Fast & Fresh Full Kit – 2 side panels, 1 top panel	W 23" x H 56" side W 48" x H 8" header	1	1,670.00
CSFLEXMERCH2	Pickup & Go Full Kit – 2 side panels, 1 top panel	W 23" x H 56" side W 48" x H 8" header	1	1,670.00
CSFLEXMERCH3	Fast & Fresh Top Panel Kit	W 48" x H 6 1/2"	1	840.00
CSFLEXMERCH4	Pickup & Go Top Panel Kit	W 48" x H 6 1/2"	1	840.00

Premium Flex Station Color: Speckled Gray (480).



COMPONENT*



camguard
ANTIMICROBIAL SHELF PLATES



* Shelving, and divider panels.

VERSA FOOD SERVICE SYSTEM



The Versa Food Service System provides custom design without the custom price. This non electric, versatile, portable system keeps food cold for hours with either ColdFest® pans or Buffet Camchillers®. The system is made of durable all-weather material and is easy to clean. The Versa Food Service System offers countless configurations to fit any foodservice need.

- Ergonomic, molded-in handles on both sides ensure easy maneuvering.
- Versa Food Bar and Work Table both include a drain faucet that can be connected to a hose for drainage and easy cleaning.
- Add an end table to a Food Bar or Work Table to hold trays, condiments, or paper goods.

Versa Cart

- Join a Versa Cart with a Food Bar or Work Table for fast check-out and improved traffic flow.
- The Versa Cart includes an adjustable shelf, standard lockable drawer and convenient electrical access through the top of the cart and front design panel.
- Optional tray rails easily adjust to a lower height.
- Optional pull-out keyboard tray fits inside the drawer.



All components are fully compliant with NSF requirements.

Versa Food Service System is covered under U.S. Patent 9,084,498 B2.

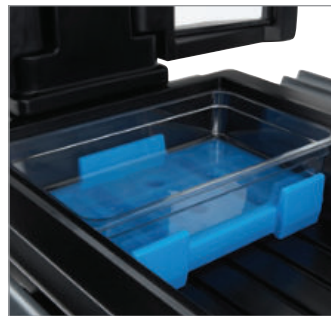

Versa Straight Connector and Versa Corner Connector

Easily and safely attach multiple components together to create a contiguous system and maximize space and merchandising options.

Buffet Camchillers

Extend safe, cold holding time without ice. Dual-sided Buffet Camchillers hold 2½" (6,5 cm) and 4" (10 cm) pans. Fits in the Versa Food Bar, Versa Work Table and Table Top Food Bars.

VERSA FOOD SERVICE SYSTEM

Whether you're looking to maximize space, improve traffic flow, add merchandising space or create an upscale salad bar, the Versa Food Service System has you covered.



Versa Food Bar®
As Shown: VBR5 shown with optional 2-VCS32R, 1-VBRTBL.



Versa Work Table

- Perfect for a prep table, display, self-serve station or back bar.
- Attach a Work Table to a Food Bar to merchandise snacks and beverages.
- Matching well covers are included with each Versa Work Table.



Standard height model.

VERSA BAR AND VERSA WORK TABLE

- Now available with two secure storage cabinets that can hold up to 50 lbs. (22,7 kg) per compartment of non-perishable items.
- Preferred Salad Bar of Salad Bars to Schools Campaign.



VRB6 with optional 2-VBRR6, 2-VBRTBL.

Storage Dimensions:
L 21½" x W 17½" x D 18" per cabinet.
Each cabinet is 3.92 cu. ft. (0,11 M³).



VERSA FOOD SERVICE SYSTEM

CODE	DESCRIPTION	OVERALL EXTERIOR DIMENSIONS L x W x H	FULL PAN SIZE CAPACITY	WELL INTERIOR DIMENSIONS L x W x H	LIST PRICE EA.
Versa Food Bars® - Standard Height					
VBR5	5' with standard casters	69" x 42½" x 62¾"	4	52⅝" x 21" x 7⅞"	\$ 4,395.00
VBRU5	5' with standard casters and storage	69" x 42½" x 62¾"	4	52⅝" x 21" x 7⅞"	5,600.00
VBRHD5	5' with heavy duty casters	69" x 42½" x 62¾"	4	52⅝" x 21" x 7⅞"	4,710.00
VBRUHD5	5' with heavy duty casters and storage	69" x 42½" x 62¾"	4	52⅝" x 21" x 7⅞"	5,915.00
VBR6	6' with standard casters	82" x 42½" x 62¾"	5	65⅞" x 21" x 7⅞"	4,575.00
VBRU6	6' with standard casters and storage	82" x 42½" x 62¾"	5	65⅞" x 21" x 7⅞"	5,980.00
VBRHD6	6' with heavy duty casters	82" x 42½" x 62¾"	5	65⅞" x 21" x 7⅞"	4,895.00
VBRUHD6	6' with heavy duty casters and storage	82" x 42½" x 62¾"	5	65⅞" x 21" x 7⅞"	6,300.00
Versa Food Bars - Low Height					
VBRL5	5' with standard casters	69" x 42½" x 55¾"	4	52⅝" x 21" x 7⅞"	4,395.00
VBRLHD5	5' with heavy duty casters	69" x 42½" x 55¾"	4	52⅝" x 21" x 7⅞"	4,710.00
VBRL6	6' with standard casters	82" x 42½" x 55¾"	5	65⅞" x 21" x 7⅞"	4,575.00
VBRLHD6	6' with heavy duty casters	82" x 42½" x 55¾"	5	65⅞" x 21" x 7⅞"	4,895.00
Versa Work Tables - Standard Height					
VBRT5	5' with standard casters	69" x 27" x 36¼"	4	52⅝" x 21" x 7⅞"	3,235.00
VBRUT5	5' with standard casters and storage	69" x 27" x 36¼"	4	52⅝" x 21" x 7⅞"	3,790.00
VBRTHD5	5' with heavy duty casters	69" x 27" x 36¼"	4	52⅝" x 21" x 7⅞"	3,560.00
VBRUTHD5	5' with heavy duty casters and storage	69" x 27" x 36¼"	4	52⅝" x 21" x 7⅞"	4,110.00
VBRT6	6' with standard casters	82" x 27" x 36¼"	5	65⅞" x 21" x 7⅞"	3,430.00
VBRUT6	6' with standard casters and storage	82" x 27" x 36¼"	5	65⅞" x 21" x 7⅞"	3,955.00
VBRTHD6	6' with heavy duty casters	82" x 27" x 36¼"	5	65⅞" x 21" x 7⅞"	3,750.00
VBRUTHD6	6' with heavy duty casters and storage	82" x 27" x 36¼"	5	65⅞" x 21" x 7⅞"	4,275.00
Versa Work Tables - Low Height					
VBRTL5	5' with standard casters	69" x 27" x 29¼"	4	52⅝" x 21" x 7⅞"	3,100.00
VBRTLHD5	5' with heavy duty casters	69" x 27" x 29¼"	4	52⅝" x 21" x 7⅞"	3,425.00
VBRTL6	6' with standard casters	82" x 27" x 29¼"	5	65⅞" x 21" x 7⅞"	3,290.00
VBRTLHD6	6' with heavy duty casters	82" x 27" x 29¼"	5	65⅞" x 21" x 7⅞"	3,610.00

Case Pack: 1

CODE	DESCRIPTION	OVERALL EXTERIOR DIMENSIONS W x D x H	LIST PRICE EA.
Versa Cart			
VCSWR	With dual tray rails and standard casters	52¾" x 32" x 43" (with tray rails up)	\$ 3,405.00
VCSWRHD	With dual tray rails and heavy duty casters	52¾" x 32" x 43¾" (with tray rails up)	4,290.00
VCS	With standard casters and no tray rails	32¼" x 32" x 43"	3,305.00
VCSHD	With heavy duty casters and no tray rails	32¼" x 32" x 43¾"	3,645.00
Connectors		L x W x H	
VBRC	Straight connector - food bar to food bar	27" x 19" x 4¼"	242.00
VBRC90	Corner connector - food bar to food bar	36" x 36" x 4¼"	418.00
VCS32CNT	Straight connector - cart to standard height food bar / work table	27" x 20⅝" x 3¼"	434.00
VCSCNL	Straight connector - cart to low height food bar / work table	27" x 20⅝" x 8½"	525.00

Case Pack: 1

Versa Food Bar, Versa Work Table, Versa Cart, Connectors, Well Cover Color:

InStock Color



Black

Made to Order Colors for Versa Food Bar, Versa Work Table, Versa Cart, Connectors, Well Cover, Tray Rail and End Table:



Hot Red



Navy Blue



Kentucky Green

Made To Order Items Not Carried In Stock, Non-Returnable.

Tray Rail and End Table Colors Only:

InStock Colors



Granite Gray



**Black

**Made to order color for 1 Tray Rail and 1 End Table. These must be ordered in increments of 2 each. (Minimum of 2 each).

FOOD BAR ACCESSORIES

Every Accessory You Need

- Crock and salad bowl holders highlight and organize salads, condiments and dressings.
- Tray rails offer convenience for your patrons.

See Camwear® Food Pans and Crocks section for more information.

Versa Cart with Dual Tray Rails (VCSWR & VCSWRHD): All orders receive the tray rails in Granite Gray (191). To choose a different color tray rail you must order the Versa Cart Without Rails (VCS or VCSHD) and the tray rails (VCS32R) separately.

Connector Colors: Black (110), Hot Red (158), Navy Blue (186), Kentucky Green (519).

Vinyl Cover Color: Opaque (000).

Sign Holder Color: Clear (152).

Buffet Camchiller® Color: Cold Blue (159).

Divider Bar Colors: White (148), Clear (152).

Well Cover Colors: Black (110), Hot Red (158), Navy Blue (186), Kentucky Green (519).

Keyboard Tray Color: Black (110).

Crock, Salad Bowl Holders Colors: White (148), Granite Gray (191).

Versa Food Bar is covered under U.S. Patent D 615,323 S and D 620,730. Versa Food Bar Ultra Series is covered under U.S. Patent D702,066 S. Versa Cart is covered under U.S. Patent D 653,830 S. Buffet Camchiller is covered under U.S. Patent D 618,476 S. All other parts patent pending.

*Items are not NSF Listed.



- 6 ft. models hold 5 full size pans with divider bars.
- 5 ft. models hold 4 full size pans with divider bars.

- Fractional size pans can be used in many variations with divider bars. Mix and match sizes to fit your needs.

Two salad bowl holder models available, SBH18 and SBH15. Crock holder, CPH3, holds 1.5 and 2.7 qt. crocks.

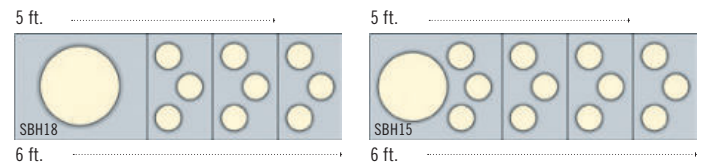

- 6 ft. models hold a salad bowl holder and 3 ea. crock holders.
- 5 ft. models hold a salad bowl holder and 2 ea. crock holders.

CODE	DESCRIPTION	OVERALL EXTERIOR DIMENSIONS	CASE PACK	LIST PRICE EA.
VBRR5	Tray rail for 5' - Versa Food Bar / Work Table	L 53" x W 11½" x H 4¾"	1	\$ 590.00
VBRR6	Tray rail for 6' - Versa Food Bar / Work Table	L 66" x W 11½" x H 4¾"	1	625.00
VCS32R	Tray rail for - Versa Cart	L 28" x W 11½" x H 5"	1	478.00
VBRTBL	End table for Versa Food Bar and Work Table	L 27" x W 22" x H 4½"	1	630.00
VBRCVR5*	Vinyl cover for 5' Versa Food Bar	L 73" x W 43½" x H 46"	1	380.00
VBRCVR6*	Vinyl cover for 6' Versa Food Bar	L 83" x W 43½" x H 46"	1	417.00
VBRTCVR5*	Vinyl cover for 5' Versa Work Table	L 70" x W 33½" x H 21"	1	202.00
VBRTCVR6*	Vinyl cover for 6' Versa Work Table	L 83" x W 33½" x H 21"	1	219.00
VCSCVR*	Vinyl cover for Versa Cart	L 42" x W 33" x H 36"	1	202.00
VBRSHTS*	Versa Food Bar sign holder	L 36" x W 6" x H 9¼"	1	343.00
DIV12	12" divider bars	L 12¾"	3	5.35
DIV20	20" divider bars	L 20⅞"	3	12.60
CPH3	Crock holder holds 1.5 & 2.7 qt.	L 12⅞" x W 20⅞"	1	96.25
SBH15	Salad bowl holder holds a 15" bowl and 3 crocks	L 25¾" x W 20⅞"	1	98.00
SBH18	Salad bowl holder holds an 18" bowl	L 25¾" x W 20⅞"	1	98.00
CPB1220	Buffet Camchiller for Versa Food Bars, Work Tables and table top food bars	L 18½" x W 12⅝" x H 4"	1	255.00
VBRWC	Versa well cover for Versa Food Bar / Work Table	L 20⅞" x W 13" x H 2"	1	182.00
VCS32KEYT	Versa Cart keyboard tray	L 20⅞" x W 10⅞" x H 2"	1	139.00

Versa Food Bar Well Cover InStock Color: Black (110).

TABLE TOP FOOD BARS, BUFFET BARS & SNEEZE GUARDS



Table Top Food Bars

- Turn a 4'-6' (122-183 cm) table into a double-sided self service buffet or beverage station.

- Thick, foam-insulated well keeps food cold for hours with Buffet Camchillers® or ice.
- Drain plug allows for quick and easy clean-up.

Buffet Bars

- Ideal for holding snacks and cold beverages.
- The Buffet Bar with Sneeze Guard is perfect for single-sided, self-serve buffets.

BUF48 and BUF72 are NSF listed.

BUF48 can be shipped by parcel carrier.

*NSF listed for non-direct food contact only.



4FBRTT Table Top Food Bar
Buffet Camchiller available.



BBR480 Buffet Bar
with Sneeze Guard



BUF48 Buffet Bar Base
Merchandises soft drinks on ice to increase beverage sales.

CODE	OVERALL EXTERIOR DIMENSIONS	FULL SIZE PAN CAPACITY	WELL INTERIOR DIMENSIONS	LIST PRICE EA.
Table Top Food Bars				
	L x W x H		L x W x D	
6FBRTT	71½" x 33¼" x 27"	5	62⅞" x 20⅞" x 6½"	\$ 2,395.00
5FBRTT	63½" x 33¼" x 27"	4	50⅞" x 20⅞" x 6½"	2,227.94
4FBRTT	51" x 33¼" x 27"	3	37¼" x 20⅞" x 6½"	2,015.00
Buffet Bars				
	L x W x H		L x W x D	
BUF72	67½" x 24" x 7"	5	62⅞" x 20⅞" x 5"	680.00
BUF48	41⅓" x 24" x 7"	3	37¼" x 20⅞" x 5"	595.00
Buffet Bars w/Sneeze Guard				
	L x W x H		L x W x D	
BBR720	73⅞" x 24⅞" x 24½"	5	62⅞" x 20⅞" x 5"	1,325.00
BBR480	48" x 24⅞" x 24½"	3	37⅞" x 20⅞" x 5"	1,120.00

Case Pack: 1 Made to Order Colors: Black (110), Navy Blue (186), Kentucky Green (519), Hot Red (158).



VERSA ORGANIZERS

- Use to store non-perishable condiments, disposable ware and napkins.
- Hold bins in 2 x 3, 2 x 4, 3 x 3, or 3 x 4 arrangements.
- Made of seamless, one-piece polyethylene.
- Set on flat surface or wall mount each bin holds up to 10 lbs. (4,5 kg).
- Easy to assemble and easy to clean.

Bins Only

Colors: Dark Brown (131), Black (110), Slate Blue (401), Speckled Gray (480).

Versa Line Combined Pack Bins & Racks

Colors: Black (110), Speckled Gray (480).



12RS12 Versa Organizer shown mounted on wall.



Bins sold separately (5412CBP) or as combined packs.



12RS12



9RS9



8RS8



6RS6

CODE	DESCRIPTION	PRODUCT DIMENSIONS	CASE PACK	LIST PRICE EA.
Bins				
5412CBP	Bin only	W x D x H 5" x 12" x 4 1/4"	12	\$ 13.15
Versa Line Combined Pack				
12RS12	Rack w/12 bins	L x D x H (complete unit) 25 1/8" x 21 3/8" x 14 1/4"	1	261.00
9RS9	Rack w/9 bins	20 7/8" x 21 3/8" x 14 1/4"	1	231.00
8RS8	Rack w/8 bins	25 1/8" x 17 1/4" x 9 1/4"	1	211.00
6RS6	Rack w/6 bins	20 7/8" x 17 1/4" x 9 1/4"	1	188.00

PORTABLE CAMBARS®



A BAR FOR ALL OCCASIONS.

Portable and versatile, the CamBar makes outfitting events an opportunity rather than a hassle. CamBars deliver function and style whether you're pouring a drink from a bottle or creating a wide-variety of on-demand beverages.

BUILD YOUR CAMBAR®

SIZE Cambars® come in three sizes



SMALL | DIMENSIONS
Length: 54"
Width: 25 7/8"
Height: 46 1/8"



MEDIUM | DIMENSIONS
Length: 67 1/2"
Width: 28 1/2"
Height: 47 1/2"



LARGE | DIMENSIONS
Length: 72 3/4"
Width: 26"
Height: 48"

DESIGN Select from a variety of colors and decors [Click to enlarge the images](#)

STANDARD DECOR



DESIGNER DECOR



FEATURES Cambars® offer a variety of features to satisfy any beverage needs



Post-Mix 8 button
(BAR730 Complete System)



Pre-Mix 6 button
(BAR730 Complete System)



Exclusive Cold Plate

- 5 & 7-bottle speed rail
- 80-pound (36,3 kg) capacity ice sink
- Four 5" (12,7 cm) swivel casters, 2 with brake
- Vinyl cover
- Ice sink cover
- Waste-water bin
- Retainer Strap



BAR540

Highly portable, compact beverage bar for limited space.



DIMENSIONS

Length: 54"
Width: 25 7/8"
Height: 46 1/8"

FEATURES

- 5-bottle speed rail
- 80-pound (36,3 kg) capacity ice sink
- Vinyl cover

AVAILABLE IN THESE COLORS



Black
110



Dark Brown
131



Slate Blue
401



Granite Gray
191



Granite Sand
194



Charcoal Gray
615

Click to enlarge the images 

BAR540

BAR540DS

ICE SINK AND COVER

Sink Only

Sink Only

SPEED RAIL

5 bottle

5 or 7 bottle

VINYL COVER

YES

YES

All BAR540 models include four 5" (12,7 cm) swivel casters, two with brake.

BAR650

Mid-size beverage bar that fits standard elevators, ideal for off-premises catering.



DIMENSIONS

Length: 67 1/2"

Width: 28 1/2"

Height: 47 1/2"

FEATURES

- 7-bottle speed rail
- 80-pound (36,3 kg) capacity ice sink
- Vinyl cover
- Ice sink and cover
- Waste-water bin
- Retainer Strap

AVAILABLE IN THESE COLORS



Black
110



Granite Gray
with Black
Base
420



Chicago
770



Carmel
669

Click to enlarge the images 

	BAR650 BAR650DS	BAR650CP BAR650DSCP	BAR650PM BAR650DSPM	BAR650PMT BAR650DSPMT	BAR650DX BAR650DSDX
BAG IN BOX SYRUPS PUMPS			3	3	
BAG IN BOX RACK (HOLDS 3 BOXES)			1	1	
CARBONATOR			YES	YES	
CO2 REGULATOR			YES	YES	YES
CO2 CLAMP & CHAIN		YES	YES	YES	YES
8 CIRCUIT COLD PLATE IN ICE SINK		YES	YES	YES	YES
ICE SINK AND COVER	YES	YES	YES	YES	YES
RETAINER STRAP	1	1	1	1	1
SPEED RAIL	7 bottle	7 bottle	7 bottle	7 bottle	7 bottle
WATER PUMP			YES	YES	
WATER TANK				YES	
WATER LINK HOOK UP (CITY SOURCE)			YES	YES	
WASTE WATER BIN	YES	YES	YES	YES	YES
VINYL COVER	YES	YES	YES	YES	YES

All BAR650 and BAR730 models include four 6" (15,24 cm) swivel casters, two with brake.

BAR730

Spacious rolling bar for banquets and large events.



DIMENSIONS

Length: 72 3/4"

Width: 26"

Height: 48"

FEATURES

- 7-bottle speed rail
- 80-pound (36,3 kg) capacity ice sink
- 6 & 8-button soda gun
- Vinyl cover
- Ice sink and cover
- Waste-water bin Retainer Strap

AVAILABLE IN THESE COLORS



Black
110



Granite Gray with
Black Base
420



Chicago
770



Carmel
669

Click to enlarge the images

	BAR730 BAR730DS	BAR730CP BAR730DSCP	BAR730PM BAR730DSPM	BAR730PMT BAR730DSPMT	BAR730DX BAR730DSDX
BAG IN BOX SYRUPS PUMPS			6	6	
BAG IN BOX RACK (HOLDS 3 BOXES)			2	2	
CARBONATOR			YES	YES	
CO2 REGULATOR			YES	YES	YES
CO2 CLAMP & CHAIN		YES	YES	YES	YES
8 CIRCUIT COLD PLATE IN ICE SINK		YES	YES	YES	YES
ICE SINK AND COVER	YES	YES	YES	YES	YES
RETAINER STRAP	2	2	2	2	2
SODA GUN			8 button	8 button	6 button
SPEED RAIL	7 bottle	7 bottle	7 bottle	7 bottle	7 bottle
WATER PUMP			YES	YES	
WATER TANK				YES	
WATER LINK HOOK UP (CITY SOURCE)			YES	YES	
WASTE WATER BIN	YES	YES	YES	YES	YES
VINYL COVER	YES	YES	YES	YES	YES

All BAR650 and BAR730 models include four 6" (15,24 cm) swivel casters, two with brake.

CAMBAR® POST-MIX FEATURES

Redesigned for Peak Functionality

- Soda gun and GFI-protected 110V outlet are ergonomically positioned for convenient operation access and maximized workspace.

- NSF listed beverage line with Flushable Glas-Flex™ liner for easy flushing and changing of even the strongest flavors.
- Hygienic and easy-to-clean.

FRONT

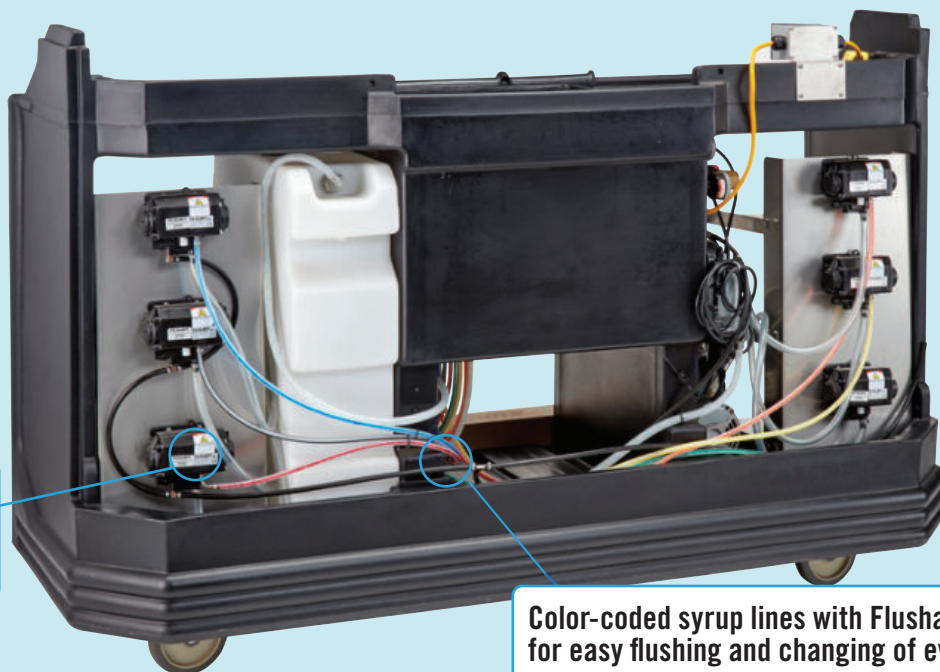

Pumps built into stainless steel box.

Color-coded syrup lines with Flushable Glas-Flex™ liner for easy flushing and changing of even the strongest flavors.

BACK

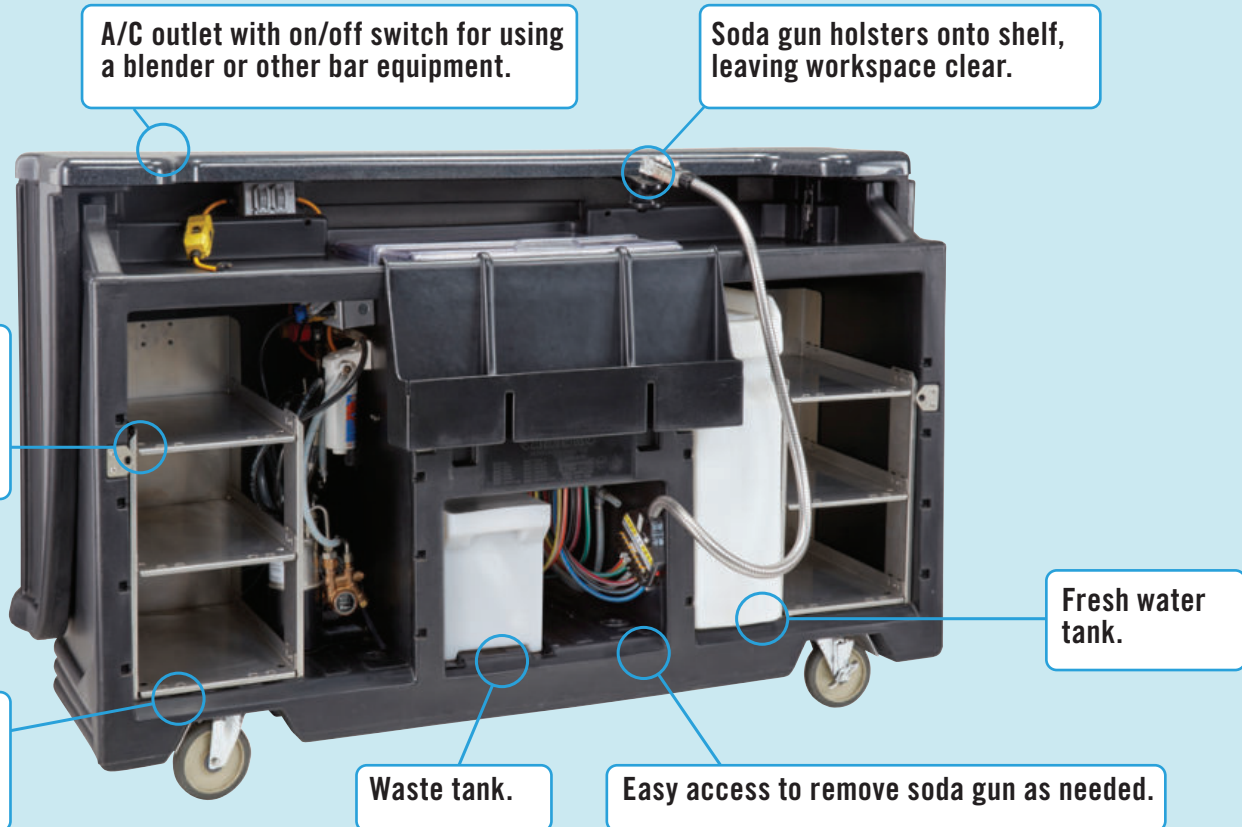

A/C outlet with on/off switch for using a blender or other bar equipment.

Soda gun holsters onto shelf, leaving workspace clear.

Straps with molded anchors and eyelets anchor tanks to the unit.

Fresh water tank.

Stainless steel rack to hold bag in the box.

Waste tank.

Easy access to remove soda gun as needed.

CAMBAR® INDEX

CODE	VOLTS	WATER TANK	DECOR	DIMENSIONS (L x W x H)	UNIT WEIGHT	LIST PRICE EA.
BAR540						
BAR540			Standard	54" x 25 7/8" x 46 1/8"	117 lbs.	\$ 3,470.00
BAR540DS			Designer	54" x 25 7/8" x 46 1/8"	123 lbs.	\$ 4,410.00
BAR650						
BAR650			Standard	67 1/2" x 28 1/2" x 47 1/2"	173 lbs.	\$ 6,780.00
BAR650DS			Designer	67 1/2" x 28 1/2" x 47 1/2"	220 lbs.	\$ 9,135.00
BAR650CP			Standard	67 1/2" x 28 1/2" x 47 1/2"	285 lbs.	\$ 9,970.00
BAR650DSCP	110		Designer	67 1/2" x 28 1/2" x 47 1/2"	303 lbs.	\$ 12,870.00
BAR650PM	110	YES	Standard	67 1/2" x 28 1/2" x 47 1/2"	301 lbs.	\$ 18,275.00
BAR650PMT	110		Standard	67 1/2" x 28 1/2" x 47 1/2"	312 lbs.	\$ 20,025.00
BAR650DSPMT	110	YES	Designer	67 1/2" x 28 1/2" x 47 1/2"	348 lbs.	\$ 22,870.00
BAR650DSDX			Designer	67 1/2" x 28 1/2" x 47 1/2"	359 lbs.	\$ 14,800.00
BAR730						
BAR730			Standard	72 3/4" x 26" x 48"	198 lbs.	\$ 7,930.00
BAR730DS			Designer	77 5/8" x 28 1/2" x 47 1/2"	245 lbs.	\$ 10,670.00
BAR730CP			Standard	72 3/4" x 26" x 48"	291 lbs.	\$ 11,325.00
BAR730DSCP			Designer	77 5/8" x 28 1/2" x 47 1/2"	321 lbs.	\$ 15,980.00
BAR730PM	110		Standard	72 3/4" x 26" x 48"	335 lbs.	\$ 19,650.00
BAR730PMT	110	YES	Standard	72 3/4" x 26" x 48"	346 lbs.	\$ 21,480.00
BAR730DSPM	110		Designer	77 5/8" x 28 1/2" x 47 1/2"	388 lbs.	\$ 22,180.00
BAR730DSPMT	110	YES	Designer	77 5/8" x 28 1/2" x 47 1/2"	398 lbs.	\$ 24,970.00
BAR730DX			Standard	72 3/4" x 26" x 48"	293 lbs.	\$ 13,105.00
BAR730DSDX		YES	Designer	77 5/8" x 28 1/2" x 47 1/2"	332 lbs.	\$ 17,525.00

OPTIONAL ACCESSORIES FOR CAMBARS

CODE	DESCRIPTION	LIST PRICE EA.
650WS	Wire shelf for BAR650	\$ 233.90
730WS	Wire shelf for BAR730	\$ 152.20
730SR	7 bottle speed rail	\$ 178.30
BAR54SR	5 bottle speed rail	\$ 132.30



SLIDINGLID™ ICE CADDIES



- Polyethylene body and thick foam insulation hold ice for days.
- Rugged, all-weather exterior will not crack, dent, bubble, chip, rust or break.
- Unique sliding lid slides back and under during use, reducing risk of cross-contamination.
- Recessed well and drain shelf keep ice out of water, extending holding times.
- Recessed, molded-in handles ease lifting and maneuvering.
- Slant top sliding lid units fit under prep/catering tables and counters.



ICS175LB
(Short) Shown with Rear Easy Wheels.



ICS125L
(Short)



ICS100L
(Short)



ICS175T
(Tall)



ICS175TB
(Tall) Shown with Rear Easy Wheels.



ICS200TB
(Tall) Shown with Rear Wide Easy Wheels.

Colors: Black (110), Slate Blue (401), Dark Brown (131), Coffee Beige (157), Granite Gray (191).

Personalization available. Special quote only. Contact customer service.

SlidingLid Ice Caddies ICS125L and ICS125LB are covered by US Patent D 468,071 S. SlidingLid Ice Caddies ICS100L and S are covered by US Patent D 424,883.



Caster Descriptions

Refers to caster type in chart.
All casters are 5" (12,7 cm).

A: 2 fixed, 2 swivel, 1 with brake

A1: 2 swivel, 2 with brakes

B: 4 swivel, 1 with brake

C: 2 swivel, 1 with brake,
2, 8" Easy Wheels

D: 2 swivel, 1 with brake,
2, 10" Easy Wheels

E: 2 swivel, 1 with brake,
2, 10" Wide Easy Wheels



BAR650DS shown in Designer Decor Sedona (668) with ICS175TB shown in Granite Gray (191).

CODE	HOLDING CAPACITY LBS.	EXTERIOR DIMENSIONS W x D x H	CASTER TYPE	LIST PRICE EA.
Short				
ICS100L	100	22½" x 30¾" x 28¾"	A1	\$ 1,380.00
ICS100L4S	100	22½" x 30¾" x 28¾"	B	1,420.00
ICS125L	125	23" x 31½" x 29¼"	A	1,415.00
ICS125LB	125	23" x 31½" x 29¼"	C	1,510.00
ICS175L	175	24" x 37½" x 29¼"	A	1,680.00
ICS175LB	175	24" x 37½" x 29¼"	D	1,745.00
Tall				
ICS125T	125	23" x 31½" x 34½"	A	1,500.00
ICS175T	175	23" x 34" x 37½"	A	1,765.00
ICS175TB	175	23" x 34" x 37½"	D	1,875.00
ICS200TB	200	23" x 34" x 39½"	E	1,920.00

Case Pack: 1 **InStock Colors:** Black (110), Dark Brown (131).



CAMRACK® 4-IN-1 WAREWASHING SYSTEM

The Camrack System will protect glassware and keep it clean until the next event, eliminating the need for rewashing.

Efficient Washing

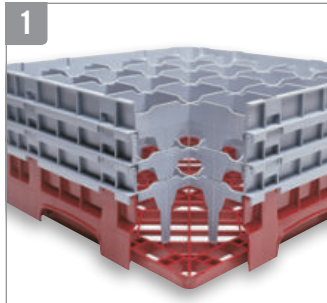

Open inside compartments provide thorough circulation of water and cleaning solutions and promote quick and thorough drying.

Long-lasting polypropylene Camracks are built to withstand chemicals and high temperatures up to 200°F (93°C).

Sanitary Storage



Closed outer walls keep fingers and contaminants out and reduce risk of breakage and injury. The Camrack Cover and Camdolly make this system completely enclosed. Glassware stays clean in storage, eliminating rewashing.

Inventory Control



A variety of base rack colors help identify at a glance both contents and quantity per rack. Available in 10 colors.

Safe, Sanitary Transportation



Camracks can be transported across large campuses or to off-site locations in one single unit.

Easy to grip handles and smooth overlapping sides facilitate safe handling.

Camrack Cover Seals from the Top and Camdolly® Seals from the Bottom.



No Bacteria



No Dirty Hands



No Rodents



No Bugs



No Dirty Mop Water

Camracks interstack with racks from major manufacturers.



Content labeling options include one-color custom hot stamping or pre-printed clips.



Camracks are covered by one or more of the following patents: Full Base Dish Rack D 412,607. Half Base Dish Rack D 404,176. Half Dish Rack Extender D 400,321. Enlarged Dish Rack Extender D 399,614. Dish Rack with Extender 5,934,486 Utility Patent. Pronged Base Dish Rack D 403,472.

FULL SIZE CAMRACKS® FOR STEMWARE & TUMBLERS

These racks offer complete protection for all your delicate and valuable stemware and tumblers, from washing and handling to stacking, storing and transporting.

Choose the correct dishrack:

1. Measure the maximum diameter of your glass (stemware or tumbler) to determine the number of compartments.
2. Measure the maximum height of your glass (stemware or tumbler) to the top edge of the rim to determine the compartment height.

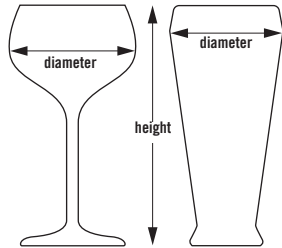

25S534

5⁷/₈" 5.875" (14,9 cm)
MAXIMUM DIAMETER



9 COMPARTMENT

MAXIMUM HEIGHT	3 ⁵ / ₈ " 3.625" (9,2 cm)	5 ¹ / ₄ " 5.25" (13,3 cm)	6 ⁷ / ₈ " 6.875" (17,4 cm)	8 ¹ / ₂ " 8.5" (21,5 cm)	10 ¹ / ₈ " 10.125" (25,7 cm)	11 ³ / ₄ " 11.75" (29,8 cm)
CODE	9S318	9S434	9S638	9S800	9S958	9S1114
CASE PACK	5	4	3	2	2	2
RACK DIMENSION	19 ³ / ₄ " x 19 ³ / ₄ " x 5 ⁵ / ₈ " 50 x 50 x 14,3 cm	19 ³ / ₄ " x 19 ³ / ₄ " x 7 ¹ / ₄ " 50 x 50 x 18,4 cm	19 ³ / ₄ " x 19 ³ / ₄ " x 8 ⁷ / ₈ " 50 x 50 x 22,5 cm	19 ³ / ₄ " x 19 ³ / ₄ " x 10 ¹ / ₂ " 50 x 50 x 26,7 cm	19 ³ / ₄ " x 19 ³ / ₄ " x 12 ⁵ / ₈ " 50 x 50 x 30,8 cm	19 ³ / ₄ " x 19 ³ / ₄ " x 13 ³ / ₄ " 50 x 50 x 34,9 cm
LIST PRICE EACH	\$ 78.00	\$ 101.50	\$ 121.75	\$ 147.75	\$ 171.00	\$ 199.00

4³/₈" 4.375" (11,11 cm)
MAXIMUM DIAMETER

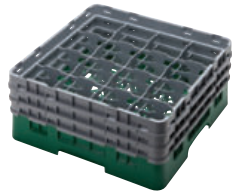

16 COMPARTMENT

MAXIMUM HEIGHT	3 ⁵ / ₈ " 3.625" (9,2 cm)	4 ¹ / ₂ " 4.5" (11,4 cm)	5 ¹ / ₄ " 5.25" (13,3 cm)	6 ¹ / ₈ " 6.125" (15,5 cm)	6 ⁷ / ₈ " 6.875" (17,4 cm)	7 ³ / ₄ " 7.75" (19,6 cm)
CODE	16S318	16S418**	16S434	16S534**	16S638	16S738**
CASE PACK	5	5	4	4	3	3
RACK DIMENSION	19 ³ / ₄ " x 19 ³ / ₄ " x 5 ⁵ / ₈ " 50 x 50 x 14,3 cm	19 ³ / ₄ " x 19 ³ / ₄ " x 5 ⁵ / ₈ " 50 x 50 x 14,3 cm	19 ³ / ₄ " x 19 ³ / ₄ " x 7 ¹ / ₄ " 50 x 50 x 18,4 cm	19 ³ / ₄ " x 19 ³ / ₄ " x 7 ¹ / ₄ " 50 x 50 x 18,4 cm	19 ³ / ₄ " x 19 ³ / ₄ " x 8 ⁷ / ₈ " 50 x 50 x 22,5 cm	19 ³ / ₄ " x 19 ³ / ₄ " x 8 ⁷ / ₈ " 50 x 50 x 22,5 cm
LIST PRICE EACH	\$ 78.00	\$ 81.50	\$ 102.00	\$ 104.50	\$ 122.75	\$ 125.00
MAXIMUM HEIGHT	8 ¹ / ₂ " 8.5" (21,5 cm)	9 ³ / ₈ " 9.375" (23,8 cm)	10 ¹ / ₈ " 10.125" (25,7 cm)	11" 11" (27,9 cm)	11 ³ / ₄ " 11.75" (29,8 cm)	12 ⁵ / ₈ " 12.625" (32 cm)
CODE	16S800	16S900**	16S958	16S1058**	16S1114	16S1214**
CASE PACK	2	2	2	2	2	2
RACK DIMENSION	19 ³ / ₄ " x 19 ³ / ₄ " x 10 ¹ / ₂ " 50 x 50 x 26,7 cm	19 ³ / ₄ " x 19 ³ / ₄ " x 10 ¹ / ₂ " 50 x 50 x 26,7 cm	19 ³ / ₄ " x 19 ³ / ₄ " x 12 ⁵ / ₈ " 50 x 50 x 30,8 cm	19 ³ / ₄ " x 19 ³ / ₄ " x 12 ⁵ / ₈ " 50 x 50 x 30,8 cm	19 ³ / ₄ " x 19 ³ / ₄ " x 13 ³ / ₄ " 50 x 50 x 34,9 cm	19 ³ / ₄ " x 19 ³ / ₄ " x 13 ³ / ₄ " 50 x 50 x 34,9 cm
LIST PRICE EACH	\$ 148.75	\$ 151.00	\$ 171.00	\$ 173.00	\$ 199.00	\$ 201.00

Base Rack Colors:

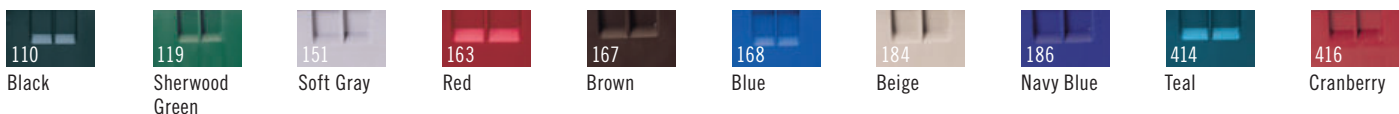

Extender Color: Soft Gray (151). **Compartment Extenders cannot be added. Personalization available. See Camrack personalization and color coding page. Contact Customer Service for all special orders.

FULL SIZE CAMRACKS® FOR STEMWARE & TUMBLERS

3⁷/₈" 3.875" (9,84 cm)
MAXIMUM DIAMETER



20 COMPARTMENT

MAXIMUM HEIGHT	3 ⁵ / ₈ " 3.625" (9,2 cm)	5 ¹ / ₄ " 5.25" (13,3 cm)	6 ⁷ / ₈ " 6.875" (17,4 cm)	8 ¹ / ₂ " 8.5" (21,5 cm)	10 ¹ / ₈ " 10.125" (25,7 cm)	11 ³ / ₄ " 11.75" (29,8 cm)
CODE	20S318	20S434	20S638	20S800	20S958	20S1114
CASE PACK	5	4	3	2	2	2
RACK DIMENSION	19 ³ / ₄ " x 19 ³ / ₄ " x 5 ⁵ / ₈ " 50 x 50 x 14,3 cm	19 ³ / ₄ " x 19 ³ / ₄ " x 7 ¹ / ₄ " 50 x 50 x 18,4 cm	19 ³ / ₄ " x 19 ³ / ₄ " x 8 ⁷ / ₈ " 50 x 50 x 22,5 cm	19 ³ / ₄ " x 19 ³ / ₄ " x 10 ¹ / ₂ " 50 x 50 x 26,7 cm	19 ³ / ₄ " x 19 ³ / ₄ " x 12 ¹ / ₂ " 50 x 50 x 30,8 cm	19 ³ / ₄ " x 19 ³ / ₄ " x 13 ³ / ₄ " 50 x 50 x 34,9 cm
LIST PRICE EACH	\$ 78.00	\$ 103.25	\$ 123.75	\$ 148.75	\$ 171.00	\$ 199.00

3⁷/₁₆" 3.44" (8,7 cm)
MAXIMUM DIAMETER



25 COMPARTMENT

MAXIMUM HEIGHT	3 ⁵ / ₈ " 3.625" (9,2 cm)	4 ¹ / ₂ " 4.5" (11,4 cm)	5 ¹ / ₄ " 5.25" (13,3 cm)	6 ¹ / ₈ " 6.125" (15,5 cm)	6 ⁷ / ₈ " 6.875" (17,4 cm)	7 ³ / ₄ " 7.75" (19,6 cm)
CODE	25S318	25S418**	25S434	25S534**	25S638	25S738**
CASE PACK	5	5	4	4	3	3
RACK DIMENSION	19 ³ / ₄ " x 19 ³ / ₄ " x 5 ⁵ / ₈ " 50 x 50 x 14,3 cm	19 ³ / ₄ " x 19 ³ / ₄ " x 5 ⁵ / ₈ " 50 x 50 x 14,3 cm	19 ³ / ₄ " x 19 ³ / ₄ " x 7 ¹ / ₄ " 50 x 50 x 18,4 cm	19 ³ / ₄ " x 19 ³ / ₄ " x 7 ¹ / ₄ " 50 x 50 x 18,4 cm	19 ³ / ₄ " x 19 ³ / ₄ " x 8 ⁷ / ₈ " 50 x 50 x 22,5 cm	19 ³ / ₄ " x 19 ³ / ₄ " x 8 ⁷ / ₈ " 50 x 50 x 22,5 cm
LIST PRICE EACH	\$ 78.00	\$ 84.25	\$ 103.25	\$ 108.50	\$ 123.75	\$ 133.50
MAXIMUM HEIGHT	8 ¹ / ₂ " 8.5" (21,5 cm)	9 ³ / ₈ " 9.375" (23,8 cm)	10 ¹ / ₈ " 10.125" (25,7 cm)	11" 11" (27,9 cm)	11 ³ / ₄ " 11.75" (29,8 cm)	12 ⁵ / ₈ " 12.625" (32 cm)
CODE	25S800	25S900**	25S958	25S1058**	25S1114	25S1214**
CASE PACK	2	2	2	2	2	2
RACK DIMENSION	19 ³ / ₄ " x 19 ³ / ₄ " x 10 ¹ / ₂ " 50 x 50 x 26,7 cm	19 ³ / ₄ " x 19 ³ / ₄ " x 10 ¹ / ₂ " 50 x 50 x 26,7 cm	19 ³ / ₄ " x 19 ³ / ₄ " x 12 ¹ / ₈ " 50 x 50 x 30,8 cm	19 ³ / ₄ " x 19 ³ / ₄ " x 12 ¹ / ₈ " 50 x 50 x 30,8 cm	19 ³ / ₄ " x 19 ³ / ₄ " x 13 ³ / ₄ " 50 x 50 x 34,9 cm	19 ³ / ₄ " x 19 ³ / ₄ " x 13 ³ / ₄ " 50 x 50 x 34,9 cm
LIST PRICE EACH	\$ 148.75	\$ 161.00	\$ 171.00	\$ 186.00	\$ 199.00	\$ 214.00

**Compartment Extenders cannot be added.

3¹/₈" 3.125" (7,94 cm)
MAXIMUM DIAMETER



30 COMPARTMENT

MAXIMUM HEIGHT	3 ⁵ / ₈ " 3.625" (9,2 cm)	5 ¹ / ₄ " 5.25" (13,3 cm)	6 ⁷ / ₈ " 6.875" (17,4 cm)	8 ¹ / ₂ " 8.5" (21,5 cm)	10 ¹ / ₈ " 10.125" (25,7 cm)	11 ³ / ₄ " 11.75" (29,8 cm)
CODE	30S318	30S434	30S638	30S800	30S958	30S1114
CASE PACK	5	4	3	2	2	2
RACK DIMENSION	19 ³ / ₄ " x 19 ³ / ₄ " x 5 ⁵ / ₈ " 50 x 50 x 14,3 cm	19 ³ / ₄ " x 19 ³ / ₄ " x 7 ¹ / ₄ " 50 x 50 x 18,4 cm	19 ³ / ₄ " x 19 ³ / ₄ " x 8 ⁷ / ₈ " 50 x 50 x 22,5 cm	19 ³ / ₄ " x 19 ³ / ₄ " x 10 ¹ / ₂ " 50 x 50 x 26,7 cm	19 ³ / ₄ " x 19 ³ / ₄ " x 12 ¹ / ₂ " 50 x 50 x 30,8 cm	19 ³ / ₄ " x 19 ³ / ₄ " x 13 ³ / ₄ " 50 x 50 x 34,9 cm
LIST PRICE EACH	\$ 81.50	\$ 104.50	\$ 126.00	\$ 151.00	\$ 176.00	\$ 199.00

FULL SIZE CAMRACKS® FOR STEMWARE & TUMBLERS

2⁷/₈" 2.875" (7,3 cm)
MAXIMUM DIAMETER



36 COMPARTMENT

MAXIMUM HEIGHT	3⁵/₈" 3.625" (9,2 cm)	4¹/₂" 4.5" (11,4 cm)	5¹/₄" 5.25" (13,3 cm)	6¹/₈" 6.125" (15,5 cm)	6⁷/₈" 6.875" (17,4 cm)	7³/₄" 7.75" (19,6 cm)
CODE	36S318	36S418**	36S434	36S534**	36S638	36S738**
CASE PACK	5	5	4	4	3	3
RACK DIMENSION	19 ³ / ₄ " x 19 ³ / ₄ " x 5 ⁵ / ₈ " 50 x 50 x 14,3 cm	19 ³ / ₄ " x 19 ³ / ₄ " x 5 ⁵ / ₈ " 50 x 50 x 14,3 cm	19 ³ / ₄ " x 19 ³ / ₄ " x 7 ¹ / ₄ " 50 x 50 x 18,4 cm	19 ³ / ₄ " x 19 ³ / ₄ " x 7 ¹ / ₄ " 50 x 50 x 18,4 cm	19 ³ / ₄ " x 19 ³ / ₄ " x 8 ⁵ / ₈ " 50 x 50 x 22,5 cm	19 ³ / ₄ " x 19 ³ / ₄ " x 8 ⁵ / ₈ " 50 x 50 x 22,5 cm
LIST PRICE EACH	\$ 81.50	\$ 88.00	\$ 104.50	\$ 113.50	\$ 126.00	\$ 140.00
MAXIMUM HEIGHT	8¹/₂" 8.5" (21,5 cm)	9³/₈" 9.375" (23,8 cm)	10¹/₈" 10.125" (25,7 cm)	11" 11" (27,9 cm)	11³/₄" 11.75" (29,8 cm)	12⁵/₈" 12.625" (32 cm)
CODE	36S800	36S900**	36S958	36S1058**	36S1114	36S1214**
CASE PACK	2	2	2	2	2	2
RACK DIMENSION	19 ³ / ₄ " x 19 ³ / ₄ " x 10 ¹ / ₂ " 50 x 50 x 26,7 cm	19 ³ / ₄ " x 19 ³ / ₄ " x 10 ¹ / ₂ " 50 x 50 x 26,7 cm	19 ³ / ₄ " x 19 ³ / ₄ " x 12 ¹ / ₈ " 50 x 50 x 30,8 cm	19 ³ / ₄ " x 19 ³ / ₄ " x 12 ¹ / ₈ " 50 x 50 x 30,8 cm	19 ³ / ₄ " x 19 ³ / ₄ " x 13 ³ / ₄ " 50 x 50 x 34,9 cm	19 ³ / ₄ " x 19 ³ / ₄ " x 13 ³ / ₄ " 50 x 50 x 34,9 cm
LIST PRICE EACH	\$ 151.00	\$ 167.00	\$ 176.00	\$ 193.00	\$ 199.00	\$ 217.00

**Compartment Extenders cannot be added.

2⁷/₁₆" 2.44" (6,2 cm)
MAXIMUM DIAMETER













49 COMPARTMENT

MAXIMUM HEIGHT	3⁵/₈" 3.625" (9,2 cm)	5¹/₄" 5.25" (13,3 cm)	6⁷/₈" 6.875" (17,4 cm)	8¹/₂" 8.5" (21,5 cm)	10¹/₈" 10.125" (25,7 cm)	11³/₄" 11.75" (29,8 cm)
CODE	49S318	49S434	49S638	49S800	49S958	49S1114
CASE PACK	5	4	3	2	2	2
RACK DIMENSION	19 ³ / ₄ " x 19 ³ / ₄ " x 5 ⁵ / ₈ " 50 x 50 x 14,3 cm	19 ³ / ₄ " x 19 ³ / ₄ " x 7 ¹ / ₄ " 50 x 50 x 18,4 cm	19 ³ / ₄ " x 19 ³ / ₄ " x 8 ⁵ / ₈ " 50 x 50 x 22,5 cm	19 ³ / ₄ " x 19 ³ / ₄ " x 10 ¹ / ₂ " 50 x 50 x 26,7 cm	19 ³ / ₄ " x 19 ³ / ₄ " x 12 ¹ / ₈ " 50 x 50 x 30,8 cm	19 ³ / ₄ " x 19 ³ / ₄ " x 13 ³ / ₄ " 50 x 50 x 34,9 cm
LIST PRICE EACH	\$ 82.75	\$ 107.00	\$ 129.25	\$ 151.00	\$ 180.00	\$ 207.00



Base Rack Colors:

 110 Black	 119 Sherwood Green	 151 Soft Gray	 163 Red	 167 Brown	 168 Blue	 184 Beige	 186 Navy Blue	 414 Teal	 416 Cranberry
---	---	--	--	--	---	---	--	---	--

Extender Color: Soft Gray (151). **Compartment Extenders cannot be added.
Personalization available. See Camrack personalization and color coding page. Contact Customer Service for all special orders.

HALF SIZE CAMRACKS® FOR STEMWARE & TUMBLERS

- Very effective for carrying less weight and for storing drinkware in space-restricted locations.
- Ideal for small under-counter glasswashers.

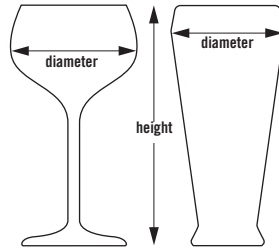

8 COMPARTMENT

4¹/₁₆" 4.06" (10,3 cm)
MAXIMUM DIAMETER



	MAXIMUM HEIGHT	3 ⁵ / ₈ " 3.625" (9,2 cm)	5 ¹ / ₄ " 5.25" (13,3 cm)	6 ⁷ / ₈ " 6.875" (17,4 cm)	8 ¹ / ₂ " 8.5" (21,5 cm)	10 ¹ / ₈ " 10.125" (25,7 cm)	11 ³ / ₄ " 11.75" (29,8 cm)
CODE		8HS318	8HS434	8HS638	8HS800	8HS958	8HS1114
CASE PACK		5	4	3	2	2	2
RACK DIMENSION		19 ³ / ₄ " x 10" x 5 ⁵ / ₈ " 50 x 25 x 14,3 cm	19 ³ / ₄ " x 10" x 7 ¹ / ₄ " 50 x 25 x 18,4 cm	19 ³ / ₄ " x 10" x 8 ⁷ / ₈ " 50 x 25 x 22,5 cm	19 ³ / ₄ " x 10" x 10 ¹ / ₂ " 50 x 25 x 26,7 cm	19 ³ / ₄ " x 10" x 12 ¹ / ₈ " 50 x 25 x 30,8 cm	19 ³ / ₄ " x 10" x 13 ³ / ₄ " 50 x 25 x 34,9 cm
LIST PRICE EACH		\$ 58.75	\$ 80.25	\$ 96.75	\$ 117.25	\$ 138.00	\$ 159.00

10 COMPARTMENT

3⁷/₁₆" 3.44" (8,7 cm)
MAXIMUM DIAMETER



	MAXIMUM HEIGHT	3 ⁵ / ₈ " 3.625" (9,2 cm)	5 ¹ / ₄ " 5.25" (13,3 cm)	6 ⁷ / ₈ " 6.875" (17,4 cm)	8 ¹ / ₂ " 8.5" (21,5 cm)	10 ¹ / ₈ " 10.125" (25,7 cm)	11 ³ / ₄ " 11.75" (29,8 cm)
CODE		10HS318	10HS434	10HS638	10HS800	10HS958	10HS1114
CASE PACK		5	4	3	2	2	2
RACK DIMENSION		19 ³ / ₄ " x 10" x 5 ⁵ / ₈ " 50 x 25 x 14,3 cm	19 ³ / ₄ " x 10" x 7 ¹ / ₄ " 50 x 25 x 18,4 cm	19 ³ / ₄ " x 10" x 8 ⁷ / ₈ " 50 x 25 x 22,5 cm	19 ³ / ₄ " x 10" x 10 ¹ / ₂ " 50 x 25 x 26,7 cm	19 ³ / ₄ " x 10" x 12 ¹ / ₈ " 50 x 25 x 30,8 cm	19 ³ / ₄ " x 10" x 13 ³ / ₄ " 50 x 25 x 34,9 cm
LIST PRICE EACH		\$ 58.75	\$ 80.25	\$ 96.75	\$ 117.25	\$ 138.00	\$ 159.00

17 COMPARTMENT

2⁷/₈" 2.875" (7,3 cm)
MAXIMUM DIAMETER



	MAXIMUM HEIGHT	3 ⁵ / ₈ " 3.625" (9,2 cm)	5 ¹ / ₄ " 5.25" (13,3 cm)	6 ⁷ / ₈ " 6.875" (17,4 cm)	8 ¹ / ₂ " 8.5" (21,5 cm)	10 ¹ / ₈ " 10.125" (25,7 cm)	11 ³ / ₄ " 11.75" (29,8 cm)
CODE		17HS318	17HS434	17HS638	17HS800	17HS958	17HS1114
CASE PACK		5	4	3	2	2	2
RACK DIMENSION		19 ³ / ₄ " x 10" x 5 ⁵ / ₈ " 50 x 25 x 14,3 cm	19 ³ / ₄ " x 10" x 7 ¹ / ₄ " 50 x 25 x 18,4 cm	19 ³ / ₄ " x 10" x 8 ⁷ / ₈ " 50 x 25 x 22,5 cm	19 ³ / ₄ " x 10" x 10 ¹ / ₂ " 50 x 25 x 26,7 cm	19 ³ / ₄ " x 10" x 12 ¹ / ₈ " 50 x 25 x 30,8 cm	19 ³ / ₄ " x 10" x 13 ³ / ₄ " 50 x 25 x 34,9 cm
LIST PRICE EACH		\$ 61.25	\$ 83.50	\$ 105.25	\$ 128.25	\$ 149.75	\$ 171.00

Base Rack Colors:

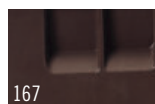

Extender Color: Soft Gray (151). Personalization available. See Camrack personalization and color coding page. Contact Customer Service for all special orders.

STEMWARE AND GLASS SIZING REFERENCE GUIDE

HALF SIZE RACKS Maximum Compartment Width

- 17 Compartment $2\frac{5}{16}$ " (73 mm)
- 10 Compartment $3\frac{1}{2}$ " (87 mm)
- 8 Compartment $4\frac{1}{8}$ " (103 mm)

To Determine Compartment Size

- **Half Size Racks:**
Place glass or stemware upside down over circle chart. Look down on the glass. Whatever circle the largest diameter of the glass fits within will determine the number of compartments.
- **Full Size Racks:**
Place glass or stemware upside down over circle chart. Look down on the glass. Whatever circle the largest diameter of the glass fits within will determine the number of compartments.

Use the vertical guide marks at right to determine item height and appropriate rack number.

FULL SIZE RACKS Maximum Compartment Width

- 49 Compartment $2\frac{1}{16}$ " (60 mm)
- 36 Compartment $2\frac{7}{8}$ " (72 mm)
- 30 Compartment $3\frac{1}{8}$ " (79 mm)
- 25 Compartment $3\frac{1}{2}$ " (87 mm)
- 20 Compartment $3\frac{7}{8}$ " (98 mm)
- 16 Compartment $4\frac{3}{8}$ " (109 mm)
- 9 Compartment $5\frac{7}{8}$ " (148 mm)

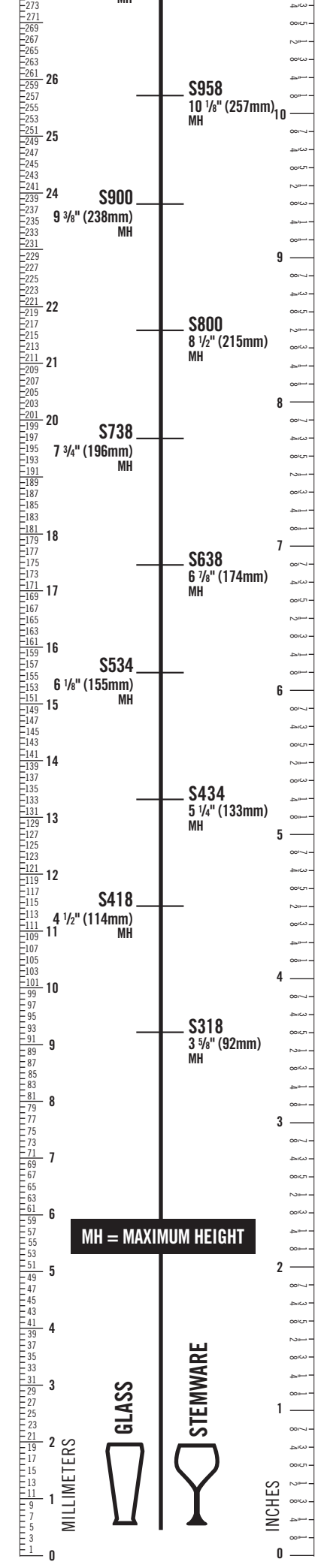

GLASS

STEMWARE

MH = MAXIMUM HEIGHT

MILLIMETERS

INCHES

CAMRACK® FULL & HALF SIZE CUP RACKS

Camrack Cup Racks

Tilt feature drains water from mug or cup bases for quick and sanitary drying.

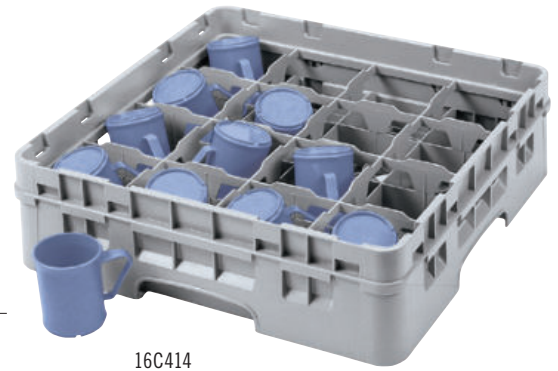
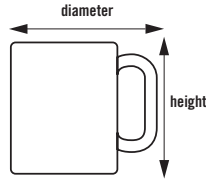

16C414

Full Size

4³/₈" X 4⁵/₁₆"
11,1 x 10,95 cm
COMPARTMENT
DIMENSIONS



16 COMPARTMENT

MAXIMUM HEIGHT	2 ⁵ / ₈ " 2.625" (6,6 cm)	4 ¹ / ₄ " 4.25" (10,7 cm)	5 ⁷ / ₈ " 5.875" (14,9 cm)
CODE	16C258	16C414	16C578
CASE PACK	6	5	4
RACK DIMENSION	19 ³ / ₄ " x 19 ³ / ₄ " x 4" 50 x 50 x 10,1 cm	19 ³ / ₄ " x 19 ³ / ₄ " x 5 ⁵ / ₈ " 50 x 50 x 14,3 cm	19 ³ / ₄ " x 19 ³ / ₄ " x 7 ¹ / ₄ " 50 x 50 x 18,4 cm
LIST PRICE EACH	\$ 55.50	\$ 77.25	\$ 115.25

4³/₈" X 3⁷/₁₆"
11,1 x 8,73 cm
COMPARTMENT
DIMENSIONS



20 COMPARTMENT

MAXIMUM HEIGHT	2 ⁵ / ₈ " 2.625" (6,6 cm)	4 ¹ / ₄ " 4.25" (10,7 cm)
CODE	20C258	20C414
CASE PACK	6	5
RACK DIMENSION	19 ³ / ₄ " x 19 ³ / ₄ " x 4" 50 x 50 x 10,1 cm	19 ³ / ₄ " x 19 ³ / ₄ " x 5 ⁵ / ₈ " 50 x 50 x 14,3 cm
LIST PRICE EACH	\$ 57.50	\$ 79.00

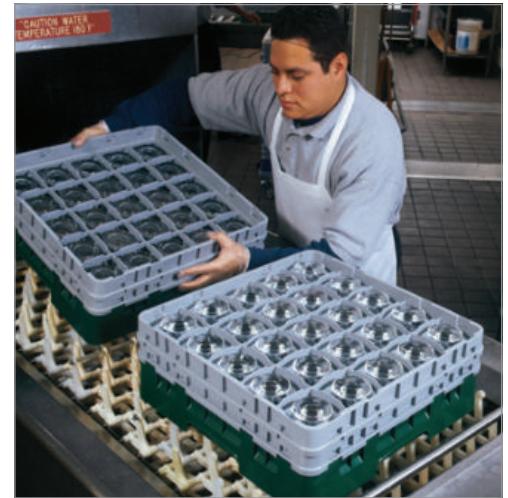

Half Size

4¹/₈" X 4³/₈"
10,4 x 11,1 cm
COMPARTMENT
DIMENSIONS



8 COMPARTMENT

MAXIMUM HEIGHT	2 ⁵ / ₈ " 2.625" (6,6 cm)	4 ¹ / ₄ " 4.25" (10,7 cm)
CODE	8HC258	8HC414
CASE PACK	6	5
RACK DIMENSION	19 ³ / ₄ " x 9 ⁷ / ₈ " x 4" 50 x 25 x 10,1 cm	19 ³ / ₄ " x 9 ⁷ / ₈ " x 5 ⁵ / ₈ " 50 x 25 x 14,3 cm
LIST PRICE EACH	\$ 39.45	\$ 65.50

4¹/₈" X 3⁷/₁₆"
10,4 x 8,73 cm
COMPARTMENT
DIMENSIONS



10 COMPARTMENT

MAXIMUM HEIGHT	2 ⁵ / ₈ " 2.625" (6,6 cm)	4 ¹ / ₄ " 4.25" (10,7 cm)
CODE	10HC258	10HC414
CASE PACK	6	5
RACK DIMENSION	19 ³ / ₄ " x 9 ⁷ / ₈ " x 4" 50 x 25 x 10,1 cm	19 ³ / ₄ " x 9 ⁷ / ₈ " x 5 ⁵ / ₈ " 50 x 25 x 14,3 cm
LIST PRICE EACH	\$ 39.45	\$ 65.50

Glass and Cup Keepers

- Raised ribs for easy draining and drying.
- Holds 20 glasses or 12 cups per layer.

Color: Beige (133).



Max. Glass Inside Rim Diameter:
GK2000: 2⁵/₈" (6,6 cm)



Max. Cup Inside Rim Diameter:
KK1200: 2¹⁵/₁₆" (7,4 cm)

CODE	SIZE	LIST PRICE EA.
Glass Keepers		
GK2000	14" x 18"	\$ 22.30
Cup Keepers		
KK1200	13 ¹⁵ / ₁₆ " x 17 ⁷ / ₈ "	20.95
Case Pack: 12		

Base Cup Rack Color: Soft Gray (151). Extender Color: Soft Gray (151). Personalization available. See Camrack personalization and color coding page. Contact Customer Service for all special orders.

CAMRACK® CUP RACK REFERENCE GUIDE



16

FULL RACK

COMPARTMENT

4³/₈" x 3¹/₂" (11,1 x 8 cm)

QUICK GUIDE

Full Size Cup Racks (C)

Maximum Cup Width	Number of Compartments	Maximum Cup Height		
		2 ⁵ / ₈ " (6,6 cm)	4 ¹ / ₄ " (10,7 cm)	5 ⁷ / ₈ " (14,9 cm)
4 ³ / ₈ " (11,1 cm)	16	16C258	16C414	16C578
3 ¹ / ₂ " (8,8 cm)	20	20C258	20C414	20C578

To determine Cup compartment size:

Turn cup or coffee mug upside down and place diagonally in square. Align handle with arrow in square. Cup or mug and handle must fit completely within boundaries of a square in order to ensure the right rack.



20

FULL RACK

COMPARTMENT

4³/₈" x 3⁷/₁₆" (11,1 x 8,73 cm)



10

HALF RACK

COMPARTMENT

4¹/₈" x 3¹/₂" (10,4 x 8,8 cm)

To Determine Cup Height:

Place base of cup or coffee mug on flat surface hold ruler vertically next to it to determine height in inches or millimeters. If the height is greater than 4¹/₄" (108 mm), additional 1⁵/₈" (41 mm) E2 and HE2 extenders may be ordered.



8

HALF RACK

COMPARTMENT

4⁷/₁₆" x 4¹/₈" (11,3 x 10,4 cm)

QUICK GUIDE

Half Size Cup Racks (HC)

Maximum Cup Width	Number of Compartments	Maximum Cup Height	
		2 ⁵ / ₈ " (6,6 cm)	4 ¹ / ₄ " (10,7 cm)
4 ¹ / ₈ " (10,4 cm)	8	8HC258	8HC414
3 ¹ / ₂ " (8,8 cm)	10	10HC258	10HC414

CAMRACK® ACCESSORIES

Camrack Cover & Camdolly®

- Use to cover and protect full size Camrack dishracks filled with clean dishware.
- When used with a Camdolly, creates a portable sanitary storage system that protects contents between uses.

- Eliminates the use of messy, wasteful plastic wrap or vinyl covers.



FULL RACK COVER	
CODE	DRC2020
EXTERIOR DIMENSIONS	19 ³ / ₈ " x 19 ³ / ₈ " x 1 ⁵ / ₁₆ " (50 x 50 x 2,4 cm)
LIST PRICE EACH	\$ 76.00

Case Pack: 1 Color: Gray (180).

	CAMDOLLY	CAMDOLLY WITH HANDLE
CODE	CDR2020	CDR2020H
INTERIOR DIMENSIONS	20 ⁷ / ₈ " x 20 ⁷ / ₈ " (53 x 53 cm)	20 ⁷ / ₈ " x 20 ⁷ / ₈ " (53 x 53 cm)
EXTERIOR DIMENSIONS	21 ³ / ₈ " x 21 ³ / ₈ " x 8" (54,5 x 54,5 x 20,5 cm)	21 ³ / ₈ " x 23 ³ / ₈ " x 37" (54,5 x 59,5 x 94 cm)
LOAD CAPACITY	350 lbs. (159 kg)	350 lbs. (159 kg)
LIST PRICE EACH	\$ 232.00	\$ 369.00

Case Pack: 1 Casters: 3¹/₂" (10 cm) casters, 4 swivel, no brakes.
Color: Soft Gray (151).

Camrack IceExpress Glass Filler

- Dramatically reduces banquet set-up time.
- Fills 25 glasses with ice all at once.
- Reduces breakage and risk of contamination.
- Ice falls directly into glasses with no spills or drips.

CODE	EXTERIOR DIM. W x D x H	LIST PRICE EA.
25SWGf	20" x 20 ⁷ / ₈ " x 1 ¹ / ₄ " (50,8 x 50,8 x 3,18 cm)	\$ 120.50

Case Pack: 1 Color: Black (110).



Selecting The Right Camrack

Cambro offers multiple ways to help you quickly find the right Camrack:

1. apps.cambro.com/Camracks

Select the item you are sizing, enter the measurements and quantity of the item, and the right Camrack will appear on the page.

2. Cambro Catalog

Flip to the back of the catalog for a convenient stemware, glass and cup sizing reference guide.

3. Cambro Sales Representatives

Contact your local Cambro representative or call Cambro Customer Service at 1 800 833 3003 to assist with specifying Camracks, dollies and covers that will fit your glasses and dishware.

4. Cambro App

Find the right Camrack for your glassware by entering the height and maximum diameter of your glass.

Choose the correct Camrack:

1. Measure the **maximum diameter** of the glass (stemware or tumbler) to determine the number of compartments.
2. Measure the **maximum height** of the glass (stemware or tumbler) to the top edge of the rim to determine the compartment height.

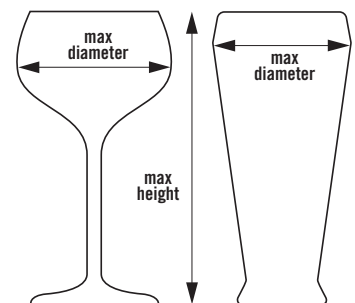

Download the app at
www.cambro.com/app or



CAMRACK® BASE RACKS

- For pots, pans, bowls and large prep, service and display items.
- Half racks work well for storing items at a wait station.



BR578

Full Size Base Racks



FULL BASE RACK

WITH 1 EXTENDER

WITH 2 EXTENDERS

WITH 3 EXTENDERS

CODE	BR258	BR414	BR578	BR712
INSIDE RACK HEIGHT	3¼" (8,3 cm)	4⅞" (12,4 cm)	6½" (16,5 cm)	8⅞" (20,6 cm)
OUTSIDE RACK HEIGHT	4" (10,1 cm)	5⅞" (14,3 cm)	7¼" (18,4 cm)	8⅞" (22,5 cm)
CASE PACK	6	5	4	3
RACK DIMENSION	19¼" x 19¼" x 4" 50 x 50 x 10,1 cm	19¼" x 19¼" x 5⅞" 50 x 50 x 14,3 cm	19¼" x 19¼" x 7¼" 50 x 50 x 18,4 cm	19¼" x 19¼" x 8⅞" 50 x 50 x 22,5 cm
LIST PRICE EACH	\$ 50.75	\$ 74.00	\$ 94.75	\$ 116.50

Half Size Base Racks



HALF BASE RACK

WITH 1 EXTENDER

WITH 2 EXTENDERS

WITH 3 EXTENDERS

CODE	HBR258	HBR414	HBR578	HBR712
INSIDE RACK HEIGHT	3¼" (8,3 cm)	4⅞" (12,4 cm)	6½" (16,5 cm)	8⅞" (20,6 cm)
OUTSIDE RACK HEIGHT	4" (10,1 cm)	5⅞" (14,3 cm)	7¼" (18,4 cm)	8⅞" (22,5 cm)
CASE PACK	6	5	4	3
RACK DIMENSION	19¼" x 9⅞" x 4" 50 x 25 x 10,1 cm	19¼" x 9⅞" x 5⅞" 50 x 25 x 14,3 cm	19¼" x 9⅞" x 7¼" 50 x 25 x 18,4 cm	19¼" x 9⅞" x 8⅞" 50 x 25 x 22,5 cm
LIST PRICE EACH	\$ 34.40	\$ 55.50	\$ 71.50	\$ 88.00

Full Size Hold Down Grid

Keeps lightweight smallwares in place during wash cycle. Use on full size Camrack Base or Flatware rack.



BR414 with CRPHDG2878

HOLD DOWN GRID

CODE	CRPHDG2878
LIST PRICE EACH	\$ 37.10
Case Pack: 6	Color: Gray (000).

Base Rack Colors:

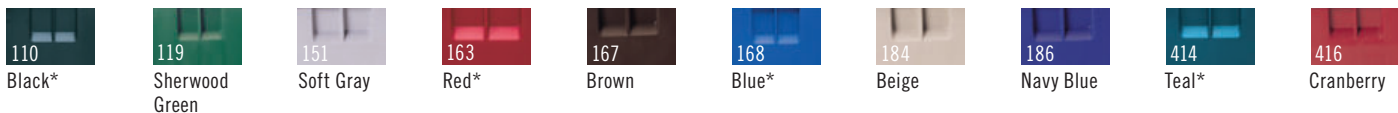

*Full size only. Extender Color: Soft Gray (151). Personalization available. See Camrack personalization and color coding page. Contact Customer Service for all special orders.

CAMRACK® FULL SIZE PEG RACKS & TRAY RACK

Standard 9 x 9 Peg Rack

- Designed to wash varying sized plates, bowls, trays and plate covers.
- Standard peg racks hold:
 - Eighteen 10" (25,4 cm) plates
 - Twelve 12" (30,5 cm) plates
 - Twenty-seven 7½" (19 cm) plates
 or
 - Nine 14" x 18" (36 x 46 cm) trays.

Versatile 5 x 9 Peg Rack

- Holds standard plates in one direction or deep plates, bowls and plate covers in the other direction.
- 5 spacing configuration holds up to ten 10" (25,4 cm) bowls, deep plates, platters or plate covers.

- 9 spacing configuration holds up to:
 - Eighteen 10" (25,4 cm) plates
 - Twelve 12" (30,5 cm) plates
 - Twenty-seven 7½" (19 cm) plates
 or
 - Nine 14" x 18" (36 x 46 cm) trays.

Open End Tray Rack

- Holds cafeteria trays or full-size sheet pans.
- Open-ended on one side for easy placement and removal of trays of all lengths.
- Holds up to nine trays upright.



9 X 9 PEG RACK

9 X 9 PEG RACK WITH 1 EXTENDER

5 X 9 PEG RACK

5 X 9 PEG RACK WITH 1 EXTENDER

OPEN END TRAY RACK

CODE	PR314	PR500	PR59314	PR59500	OETR314*
INSIDE RACK HEIGHT	3¼" (8,3 cm)	4⅞" (12,4 cm)	3¼" (8,3 cm)	4⅞" (12,4 cm)	3¼" (8,3 cm)
OUTSIDE RACK HEIGHT	4" (10,1 cm)	5⅝" (14,3 cm)	4" (10,1 cm)	5⅝" (14,3 cm)	4" (10,1 cm)
CASE PACK	6	5	6	5	6
LIST PRICE EACH	\$ 54.75	\$ 78.00	\$ 54.75	\$ 78.00	\$ 53.75

Color: Soft Gray (151). **Extender Color:** Soft Gray (151). Personalization available. See Camrack personalization and color coding page. Contact Customer Service for all special orders. *Extenders may be added to all Peg Racks except the OETR314.

CAMRACK FULL & HALF SIZE FLATWARE RACKS & CYLINDERS

Camrack Flatware Racks

- 8 Compartment Basket fits into a Full or Half Size Base Rack. Wire handles slide down for easy storage.

- Flatware Cylinder fits into 9-compartment Full Size Camrack and the Cambro Tray and Dish Cart, model TDCR12.



FULL FLATWARE RACK

HALF FLATWARE RACK

8 COMPARTMENT HALF FLATWARE BASKET

8 COMPARTMENT HALF FLATWARE BASKET

FLATWARE CYLINDER

CODE	FR258	HFR258	8FB434* with handles	8FBNH434* no handles	FWC56
INSIDE RACK HEIGHT	2⅝" (6,7 cm)	2⅝" (6,7 cm)	4¾" (12 cm)	4¾" (12 cm)	4½" wide (11,4 cm)
OUTSIDE RACK HEIGHT	4" (10,1 cm)	4" (10,1 cm)	7¼" (18,4 cm)	7¼" (18,4 cm)	5½" high (13,9 cm)
CASE PACK	6	6	6	6	12
LIST PRICE EACH	\$ 54.75	\$ 47.30	\$ 65.00	\$ 38.15	\$ 6.45

Color: Soft Gray (151). **Extender Color:** Soft Gray (151). **Flatware Cylinder Color:** White (148). Personalization available. See Camrack personalization and color coding page. Contact Customer Service for all special orders. *Extenders cannot be added.

CAMRACK® COMPONENT SYSTEM

The Camrack System offers several choices for ordering the right Camracks. Please consult with your sales representative or Cambro Customer Service for all special ordering and assembly directions.

Choose Between:

1. A complete selection of pre-assembled, ready to use Camracks listed in our catalog; or
2. Custom built special order Camracks for specific needs; or
3. Individual Camrack components for distributors to stock and build racks as needed.

Base Rack Colors:

Sherwood Green (119), Soft Gray (151), Brown (167), Beige (184), Navy Blue (186), Cranberry (416), Black (110)*, Red (163)*, Blue (168)*, Teal (414)*.

Base Cup Rack Color: Soft Gray (151).

Flatware Rack Color: Soft Gray (151).

Extender Color: Soft Gray (151).

*Full size only.

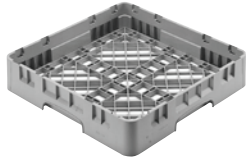

BR = Full Size Base Rack



HBR = Half Size Base Rack



E1 = Full Size Full Drop Compartment Extender



HE1 = Half Size Full Drop Compartment Extender



E2 = Full Size Half Drop Compartment Extender



HE2 = Half Size Half Drop Compartment Extender



E3 = Full Size Open Extender



HE3 = Half Size Open Extender



E4 = Full Size Full Drop Compartment Extender

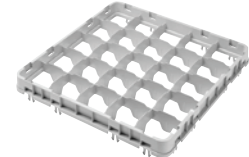

E5 = Full Size Half Drop Compartment Extender

CAMRACK COMPONENTS

Only E3 extenders may be added to E4's and E5's.

CODE	DESCRIPTION	OVERALL DIMENSIONS	COMPARTMENT	INSIDE RACK HEIGHT	CASE PACK	LIST PRICE EA.
Full Size Base Racks						
BR258	Full base rack	19¾" x 19¾" x 4" (500 x 500 x 101 mm)	18" x 18" (457 x 457 mm)	2⅝" (67 mm)	6	\$ 50.75
Half Size Base Racks						
HBR258	Half base rack	19¾" x 9⅞" x 4" (500 x 250 x 101)	18¼" x 8⅜" (464 x 213)	2⅝" (67)	6	34.40
Full Size Base Cup Racks						
16C258	16-compartment full cup rack	19¾" x 19¾" x 4" (500 x 500 x 101)	4⅜" x 4⅜" (111 x 111)	2⅝" (67)	6	55.50
20C258	20-compartment full cup rack	19¾" x 19¾" x 4" (500 x 500 x 101)	4⅜" x 3½" (111 x 89)	2⅝" (67)	6	57.50
Half Size Base Cup Racks						
8HC258	8-compartment half cup rack	19¾" x 9⅞" x 4" (500 x 250 x 101)	4⅜" x 4⅞" (105 x 113)	2⅝" (67)	6	39.45
10HC258	10-compartment half cup rack	19¾" x 9⅞" x 4" (500 x 250 x 101)	4⅜" x 3½" (105 x 89)	2⅝" (67)	6	39.45
Full Size Full Drop Extenders – E1 and GE1						
9E1	9-compartment full drop extender	19⅝" x 19⅝" x 2" (499 x 499 x 51)	5⅞" x 5⅞" (150 x 150)	1⅝" (41)	12	23.40
16E1	16-compartment full drop extender	19⅝" x 19⅝" x 2" (499 x 499 x 51)	4⅜" x 4⅜" (111 x 111)	1⅝" (41)	12	24.85
20GE1	20-compartment full drop extender	19⅝" x 19⅝" x 2" (499 x 499 x 51)	3⅞" x 3⅞" (98 x 98)	1⅝" (41)	12	26.25
25E1	25-compartment full drop extender	19⅝" x 19⅝" x 2" (499 x 499 x 51)	3½" x 3½" (89 x 89)	1⅝" (41)	12	26.25
30GE1	30-compartment full drop extender	19⅝" x 19⅝" x 2" (499 x 499 x 51)	3⅞" x 3⅞" (79 x 79)	1⅝" (41)	12	26.65
36E1	36-compartment full drop extender	19⅝" x 19⅝" x 2" (499 x 499 x 51)	2⅞" x 2⅞" (73 x 73)	1⅝" (41)	12	26.65
49E1	49-compartment full drop extender	19⅝" x 19⅝" x 2" (499 x 499 x 51)	2⅞" x 2⅞" (62 x 62)	1⅝" (41)	12	26.65
Full Size Half Drop Extenders – E2 and GE2						
9E2	9-compartment half drop extender	19⅝" x 19⅝" x 2" (499 x 499 x 51)	5⅞" x 5⅞" (150 x 150)	1⅝" (41)	12	22.10
16E2	16-compartment half drop extender	19⅝" x 19⅝" x 2" (499 x 499 x 51)	4⅜" x 4⅜" (111 x 111)	1⅝" (41)	12	22.10
20E2	20-compartment half drop extender (for cups only)	19⅝" x 19⅝" x 2" (499 x 499 x 51)	4⅜" x 3½" (111 x 89)	1⅝" (41)	12	20.35
20GE2	20-compartment half drop extender	19⅝" x 19⅝" x 2" (499 x 499 x 51)	3⅞" x 3⅞" (98 x 98)	1⅝" (41)	12	22.70
25E2	25-compartment half drop extender	19⅝" x 19⅝" x 2" (499 x 499 x 51)	3½" x 3½" (89 x 89)	1⅝" (41)	12	22.70
30GE2	30-compartment half drop extender	19⅝" x 19⅝" x 2" (499 x 499 x 51)	3⅞" x 3⅞" (79 x 79)	1⅝" (41)	12	23.95

CAMRACK® COMPONENT SYSTEM

CODE	DESCRIPTION	OVERALL DIMENSIONS	COMPARTMENT	INSIDE RACK HEIGHT	CASE PACK	LIST PRICE EA.
Full Size Half Drop Extenders – E2 and GE2 (continued)						
36E2	36-compartment half drop extender	19 ⁵ / ₈ " x 19 ⁵ / ₈ " x 2" (499 x 499 x 51 mm)	2 ¹ / ₁₆ " x 2 ¹ / ₁₆ " (73 x 73 mm)	1 ⁵ / ₈ " (41 mm)	12	\$ 23.95
49E2	49-compartment half drop extender	19 ⁵ / ₈ " x 19 ⁵ / ₈ " x 2" (499 x 499 x 51)	2 ¹ / ₁₆ " x 2 ¹ / ₁₆ " (62 x 62)	1 ⁵ / ₈ " (41)	12	23.95
Full Size Open Extender – E3						
E3	Open extender	19 ⁵ / ₈ " x 19 ⁵ / ₈ " x 2" (499 x 499 x 51)	18" x 18" (457 x 457)	1 ⁵ / ₈ " (41)	12	18.80
Full Size Full Drop Extender – E4						
16E4	16-compartment full drop extender	19 ⁵ / ₈ " x 19 ⁵ / ₈ " x 2" (499 x 499 x 51)	4 ³ / ₈ " x 4 ³ / ₈ " (111 x 111)	1 ⁵ / ₈ " (41)	12	26.65
25E4	25-compartment full drop extender	19 ⁵ / ₈ " x 19 ⁵ / ₈ " x 2" (499 x 499 x 51)	3 ¹ / ₂ " x 3 ¹ / ₂ " (89 x 89)	1 ⁵ / ₈ " (41)	12	30.40
36E4	36-compartment full drop extender	19 ⁵ / ₈ " x 19 ⁵ / ₈ " x 2" (499 x 499 x 51)	2 ⁷ / ₈ " x 2 ⁷ / ₈ " (73 x 73)	1 ⁵ / ₈ " (41)	12	34.40
Full Size Half Drop Extender – E5						
16E5	16-compartment half drop extender	19 ⁵ / ₈ " x 19 ⁵ / ₈ " x 2" (499 x 499 x 51)	4 ³ / ₈ " x 4 ³ / ₈ " (111 x 111)	1 ⁵ / ₈ " (41)	12	23.45
25E5	25-compartment half drop extender	19 ⁵ / ₈ " x 19 ⁵ / ₈ " x 2" (499 x 499 x 51)	3 ¹ / ₂ " x 3 ¹ / ₂ " (89 x 89)	1 ⁵ / ₈ " (41)	12	25.45
36E5	36-compartment half drop extender	19 ⁵ / ₈ " x 19 ⁵ / ₈ " x 2" (499 x 499 x 51)	2 ⁷ / ₈ " x 2 ⁷ / ₈ " (73 x 73)	1 ⁵ / ₈ " (41)	12	26.65
Half Size Full Drop Extenders – HE1						
8HE1	8-compartment full drop extender	19 ³ / ₄ " x 9 ⁷ / ₈ " x 2" (502 x 252 x 51)	4 ¹ / ₈ " x 4 ¹ / ₁₆ " (105 x 113)	1 ⁵ / ₈ " (41)	12	20.85
10HE1	10-compartment full drop extender	19 ³ / ₄ " x 9 ⁷ / ₈ " x 2" (502 x 252 x 51)	4 ¹ / ₈ " x 3 ¹ / ₂ " (105 x 89)	1 ⁵ / ₈ " (41)	12	20.85
17HE1	17-compartment full drop extender	19 ³ / ₄ " x 9 ⁷ / ₈ " x 2" (502 x 252 x 51)	∅ 2 ¹⁵ / ₁₆ " (∅ 74)	1 ⁵ / ₈ " (41)	12	21.70
Half Size Half Drop Extenders – HE2						
8HE2	8-compartment half drop extender	19 ³ / ₄ " x 9 ⁷ / ₈ " x 2" (502 x 252 x 51)	4 ¹ / ₈ " x 4 ¹ / ₁₆ " (105 x 113)	1 ⁵ / ₈ " (41)	12	18.75
10HE2	10-compartment half drop extender	19 ³ / ₄ " x 9 ⁷ / ₈ " x 2" (502 x 252 x 51)	4 ¹ / ₈ " x 3 ¹ / ₂ " (105 x 89)	1 ⁵ / ₈ " (41)	12	19.60
17HE2	17-compartment half drop extender	19 ³ / ₄ " x 9 ⁷ / ₈ " x 2" (502 x 252 x 51)	∅ 2 ¹⁵ / ₁₆ " (∅ 74)	1 ⁵ / ₈ " (41)	12	20.85
Half Size Open Extenders – HE3						
HE3	Open extender	19 ³ / ₄ " x 9 ⁷ / ₈ " x 2" (502 x 252 x 51)	18 ³ / ₄ " x 8 ³ / ₈ " (464 x 213)	1 ⁵ / ₈ " (41)	12	16.70

∅ = Diameter



PERSONALIZED CAMRACKS®

- Personalize Camracks to identify contents at a glance for accurate inventory control and selection.
- Hot stamp a custom logo, information or standard content symbols, and/or descriptions on two opposite, diagonal sides of any rack.
- Pre-printed clips (up to 4 per rack) can be ordered factory installed for an additional charge.



HOW TO ORDER A SAMPLE

1. Contact your local Cambro rep to complete and submit a sample request form to Cambro. Indicate location of hot stamp and/or clip on rack. Maximum hot stamp imprint size is **W 4" x H 1¼"**. Maximum hot stamp imprinting thickness per solid letter or logo should be no more than 4" wide.
2. If selecting custom hot stamping, provide ready-to-use artwork, in digital format only. Sample request form must be submitted to Cambro **PRIOR** to artwork being sent. If artwork is incomplete, graphic support services are available for \$50.00 per hour.
3. E-mail artwork to Cambro Rep or to Cambro at: letsgetpersonal@cambro.com. Title e-mail subject with logo name and provide contact info. **File dimensions:** 100% reproduction size, 300dpi resolution. **File type:** Adobe® Illustrator®, Photoshop®. **File format:** JPEG, TIFF or EPS.
4. Questions? Contact Kristie Patterson at 714-230-4125 direct or 800-854-7631 ext. 4125.
5. Signed approval form must be included with purchase order for processing. This form is included with each sample.

PERSONALIZATION CHARGES (NET)

One Time Plate Charge	\$ 100.00 (for custom hot stamp only)
Set-Up Charge	50.00
Sample Charge	50.00
Imprint Charge	1.00 per side, 2 sides max for hot stamping

STANDARD HOT STAMP SYMBOLS AND/OR DESCRIPTIONS

Step 1. Choose a symbol and corresponding letter that best fits your glassware.

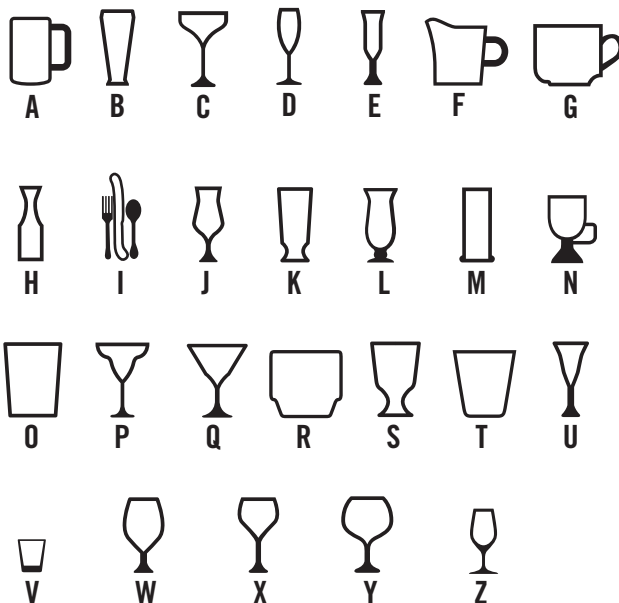

Step 2. Choose the verbiage and corresponding number that best describes your glassware. **Available in English Only.**

- | | | |
|--------------------|--------------------------|---------------------------|
| 1. Beer | 13. Flatware | 25. Rocks (Tumbler Style) |
| 2. Beer Mug | 14. Goblet | 26. Sherry |
| 3. Pilsner | 15. Grande | 27. Shot Glass |
| 4. Brandy | 16. Hi-Ball | 28. Sorbet |
| 5. Champagne | 17. Hurricane | 29. Water (Footed Style) |
| 6. Champagne Flute | 18. Iced Tea | 30. Water (Tumbler Style) |
| 7. Coffee Mug | 19. Irish Coffee | 31. White Wine |
| 8. Collins | 20. Juice | 32. Wine |
| 9. Cordial | 21. Margarita | 33. Red Wine |
| 10. Creamer | 22. Martini | 34. Port |
| 11. Cup | 23. Old Fashion | |
| 12. Decanter | 24. Rocks (Footed Style) | |

Step 3. Select hot stamp color. Choose from white, black, red or blue.

HOT STAMP OPTIONS



CUSTOM LOGO AND/OR TEXT



STANDARD SYMBOL AND DESCRIPTION



STANDARD SYMBOL ONLY



STANDARD DESCRIPTION ONLY

CAMRACK® EXTENDER ID CLIP











- The industry's only 4-in-1 glassware management system makes inventory management quick and easy.
- Made of ABS, these clips are virtually unbreakable, and designed to withstand the high heat of commercial dishwashers.
- An economical and sustainable solution to discarding existing racks or labeling with markers, tape or wall placards.
- Snap ID clips onto existing racks or have factory installed with new Camrack orders, up to 4 per rack, placed on the left only on each side as shown in image. Installation cost is \$.90 net per clip (charged in addition to actual cost per clip).



PRE-PRINTED CLIPS (Available in 6-packs only, no broken bags.) **\$ 2.35 List per clip**
FACTORY INSTALLED CLIPS \$.90 Net per clip

		CODE
	Beer	CECBE6000
	Beer Mug	CECBM6000
	Brandy	CECBR6000
	Champagne	CECCH6000
	Champagne Flute	CECCF6000
	Coffee Mug	CECCM6000
	Collins	CECCL6000
	Cordial	CECCO6000
	Creamer	CECCR6000
	Cup	CECCP6000
	Decanter	CECDC6000
	Flatware	CECFL6000

		CODE
	Goblet	CECGO6000
	Grande	CECGR6000
	Hi-Ball	CECHB6000
	Hurricane	CECHU6000
	Iced Tea	CECIT6000
	Irish Coffee	CECIC6000
	Juice	CECJU6000
	Margarita	CECMG6000
	Martini	CECMT6000
	Old Fashion	CECOF6000
	Pilsner	CECPI6000
	Red Wine	CECRW6000

		CODE
	Rocks (footed style)	CECRF6000
	Rocks (tumbler style)	CECRT6000
	Sherry	CECSH6000
	Shot Glass	CECSG6000
	Sorbet	CECSB6000
	Water (footed style)	CECWF6000
	Water (tumbler style)	CECWT6000
	White Wine	CECWW6000
	Wine	CECWI6000
	Port	CECPO6000
		CECBL6000
		Blank Clip (\$ 2.00 list per clip)

(Available in English only)

CAMDOLLIES®

- Use to easily transport multiple products in house and/or off site.
- Reduce employee lifting and carrying and possible injury.
- Made of extremely durable plastic that will not dent, crack, rust or corrode.
- Heavy-duty casters maneuver easily over all types of terrain.
- For heavy transport needs, select models with handles and Rear Big Wheels.

Colors: Coffee Beige (157), Dark Brown (131), Black (110), Slate Blue (401).
CDR2020, CDR2020H Color: Soft Gray (151).

Caster Type

- A:** 5" casters: 2 fixed, 2 swivel, 1 with brake.
B: 3" casters: 4 swivel, no brakes.
C: 10" rear big wheels, 2 front 5" swivel casters, 1 with brake.
D: 3½" casters: 4 swivel, no brakes.

Case Pack: 1

Camdollies for Camracks®

CODE	CDR2020
EXTERNAL DIM. W x D x H	21½" x 20⅞" x 7⅞"
INTERIOR DIM. W x D	20⅞" x 20⅞"
LIST PRICE EACH	\$ 232.00

350 lbs. CAPACITY	D CASTER TYPE		
----------------------	------------------	---	---



InStock Color:
Soft Gray (151)

CODE	CDR2020H
EXTERNAL DIM. W x D x H	20⅞" x 25¼" x 36½"
INTERIOR DIM. W x D	20⅞" x 20⅞"
LIST PRICE EACH	\$ 369.00

350 lbs. CAPACITY	D CASTER TYPE		
----------------------	------------------	---	---



With powder coated handle.

CODE	CD2020
EXTERNAL DIM. W x D x H	22½" x 22½" x 8¼"
INTERIOR DIM. W x D	20⅞" x 20⅞"
LIST PRICE EACH	\$ 402.00

300 lbs. CAPACITY	B CASTER TYPE			
----------------------	------------------	---	---	---



CODE	CD2020H
EXTERNAL DIM. W x D x H	22½" x 25⅞" x 36⅞"
INTERIOR DIM. W x D	20⅞" x 20⅞"
LIST PRICE EACH	\$ 630.00

350 lbs. CAPACITY	B CASTER TYPE		
----------------------	------------------	---	---



CODE	CD2020HB
EXTERNAL DIM. W x D x H	26¼" x 26½" x 36⅞"
INTERIOR DIM. W x D	20⅞" x 20⅞"
LIST PRICE EACH	\$ 815.00

350 lbs. CAPACITY	C CASTER TYPE		
----------------------	------------------	---	---



Camdollies for 18" x 26" Trays or Sheet Pans

CODE	CD1826H
EXTERNAL DIM. W x D x H	20" x 31½" x 38¼"
INTERIOR DIM. W x D	18" x 26"
LIST PRICE EACH	\$ 745.00

300 lbs. CAPACITY	A CASTER TYPE		
----------------------	------------------	---	---



CODE	CD1826HB
EXTERNAL DIM. W x D x H	23½" x 32½" x 36½"
INTERIOR DIM. W x D	18½" x 26⅞"
LIST PRICE EACH	\$ 920.00

300 lbs. CAPACITY	C CASTER TYPE		
----------------------	------------------	---	---



CAMDOLLIES®

For Milk Crates and #10 Can Cases

CODE	CD1420
EXTERNAL DIM. W x D x H	16 ³ / ₄ " x 21 ³ / ₄ " x 8 ⁵ / ₁₆ "
INTERIOR DIM. W x D	13 ⁷ / ₈ " x 19 ⁵ / ₁₆ "
LIST PRICE EACH	\$ 397.00

Holds: 14" x 19" milk crates and #10 can cases.

350 lbs. CAPACITY	B CASTER TYPE		
-----------------------------	-------------------------	---	---



CODE	CD2028
EXTERNAL DIM. W x D x H	21 ⁷ / ₈ " x 30 ³ / ₄ " x 8 ¹ / ₄ "
INTERIOR DIM. W x D	19 ¹ / ₂ " x 27 ⁷ / ₈ "
LIST PRICE EACH	\$ 413.00

Holds: 14" x 19" milk crates, #10 can cases and UPC101, UPC400, 100MPC, UPC100, UPC300.

350 lbs. CAPACITY	B CASTER TYPE		
-----------------------------	-------------------------	---	---



CODE	CD1313
EXTERNAL DIM. W x D x H	16 ⁷ / ₈ " x 16 ⁷ / ₈ " x 8 ¹ / ₄ "
INTERIOR DIM. W x D	13 ¹ / ₁₆ " x 13 ¹ / ₁₆ "
LIST PRICE EACH	\$ 364.00

Holds: 13" x 13" milk crates.

250 lbs. CAPACITY	B CASTER TYPE		
-----------------------------	-------------------------	---	---



CODE	CD1327
EXTERNAL DIM. W x D x H	16" x 29" x 8 ¹ / ₄ "
INTERIOR DIM. W x D	13 ⁵ / ₈ " x 26 ⁵ / ₈ "
LIST PRICE EACH	\$ 397.00

Holds: 13" x 13" milk crates and #10 can cases.

300 lbs. CAPACITY	B CASTER TYPE		
-----------------------------	-------------------------	---	---



UTILITY TRUCKS

- Use for transporting loads up to 600 lbs.
- Large platforms for convenient loading and built-in handles for easy maneuvering.
- All models feature 5" (12,7 cm) heavy-duty casters bolted into molded-in metal backing plates.

Colors: Coffee Beige (157), Dark Brown (131), Black (110), Slate Blue (401).

Casters: 5", 2 fixed, 2 swivel, 1 with brake.

Case Pack: 1

CODE	2030UT
EXTERNAL DIM. W x D x H	19 ³ / ₄ " x 32 ⁵ / ₈ " x 38 ¹ / ₂ "
LOAD PLATFORM	19 ³ / ₄ " x 29 ⁵ / ₈ "
LIST PRICE EACH	\$ 995.00

600 lbs. CAPACITY	
-----------------------------	--



With chrome handle.

CODE	2436UTH
EXTERNAL DIM. W x D x H	24 ⁷ / ₈ " x 41 ³ / ₄ " x 36 ³ / ₄ "
LOAD PLATFORM	23 ⁵ / ₈ " x 35 ⁵ / ₈ "
LIST PRICE EACH	\$ 950.00

600 lbs. CAPACITY	
-----------------------------	--



CODE	UTHSTP (STRAP)
DIMENSION	200" long
LIST PRICE EACH	\$ 30.00



CODE	2436UTHS
EXTERNAL DIM. W x D x H	24 ⁷ / ₈ " x 41 ³ / ₄ " x 36 ³ / ₄ "
LOAD PLATFORM	23 ⁵ / ₈ " x 35 ⁵ / ₈ "
LIST PRICE EACH	\$ 1,010.00

600 lbs. CAPACITY	
-----------------------------	--



Includes two straps. UTHSTP

STANDARD ADJUSTABLE DISH CADDY S-SERIES

- Store one size dish or a combination of different sizes in a single caddy.
- Features easy-to-adjust column towers.

Colors: Black (110), Slate Blue (401), Speckled Gray (480), Dark Brown (131).

Casters: 5", 2 swivel with brakes and two 10" Easy wheels.

Vinyl cover included. Not NSF listed.

For square and rectangular plates, please contact Cambro for suggested use.



Holds plates and bowls from 4⁵/₈" to 13"

Single Size Plate Storage

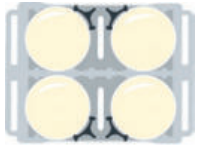

Plate sizes: 9³/₄" to 13" diam.
4 columns: (60 each)
Total Capacity: 240

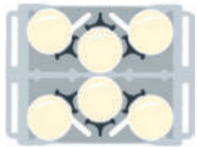

Plate sizes: 7¹/₄" to 9" diam.
6 columns: (60 each)
Total Capacity: 360

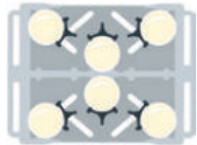

Plate sizes: 5¹/₂" to 7" diam.
6 columns: (45 each)
Total Capacity: 270

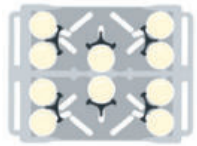
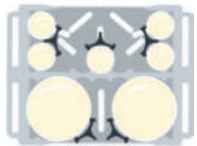
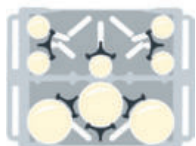

Plate sizes: 4³/₈" to 5¹/₄" diam.
10 columns: (45 each)
Total Capacity: 450

Mixed Size Plate Storage



2 columns: 9³/₄" to 13" diam. (60 each)
5 columns: 4³/₈" to 5¹/₄" (45 each)
Total Capacity: 345



3 columns: 7¹/₄" to 9" diam. (60 each)
5 columns: 4³/₈" to 5¹/₄" (45 each)
Total Capacity: 405

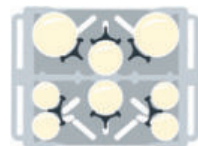

2 columns: 7¹/₄" to 9" diam. (60 each)
2 columns: 5¹/₂" to 7" (45 each)
4 columns: 4³/₈" to 5¹/₄" (45 each)
Total Capacity: 390

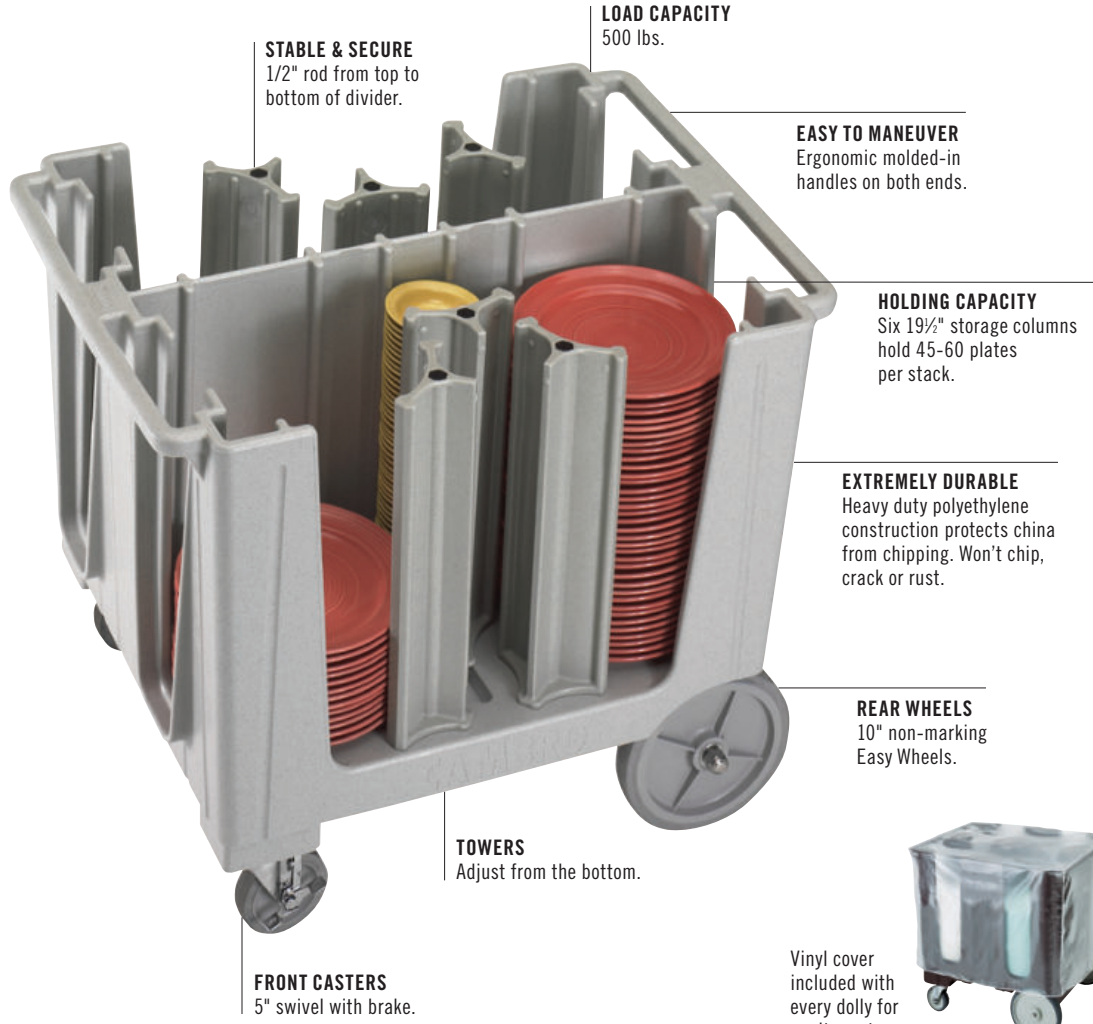

Vinyl cover included with every dolly for sanitary storage.



ADCS

NUMBER OF TOWERS: 6

PLATES PER COLUMN: Approximately 45-60

W 28³/₈" x **L** 37³/₈" x **H** 31¹/₈"

LIST PRICE EACH: \$ 1,765.00

Case Pack: 1

InStock Colors: Black (110), Speckled Gray (480).

COMPACT ADJUSTABLE DISH CADDY S-SERIES

- Space saving design holds dishes of various sizes without compromising capacity.
- Lightweight, easy to maneuver and access from all four sides.

Color: Speckled Gray (480).
5" Casters: 2 rigid, 2 swivel with brake.
Note: Cannot be used to store square, rectangular or oval plates.
 Compact Adjustable Dish Caddy is covered by U.S. Patent 10,321,778 B2.
 CamLever Tower is covered by U.S. Patent D844, 928 S and D852,450 S.
 Vinyl cover included. Not NSF Listed.



Holds plates and bowls from 4⁵/₈" to 12"

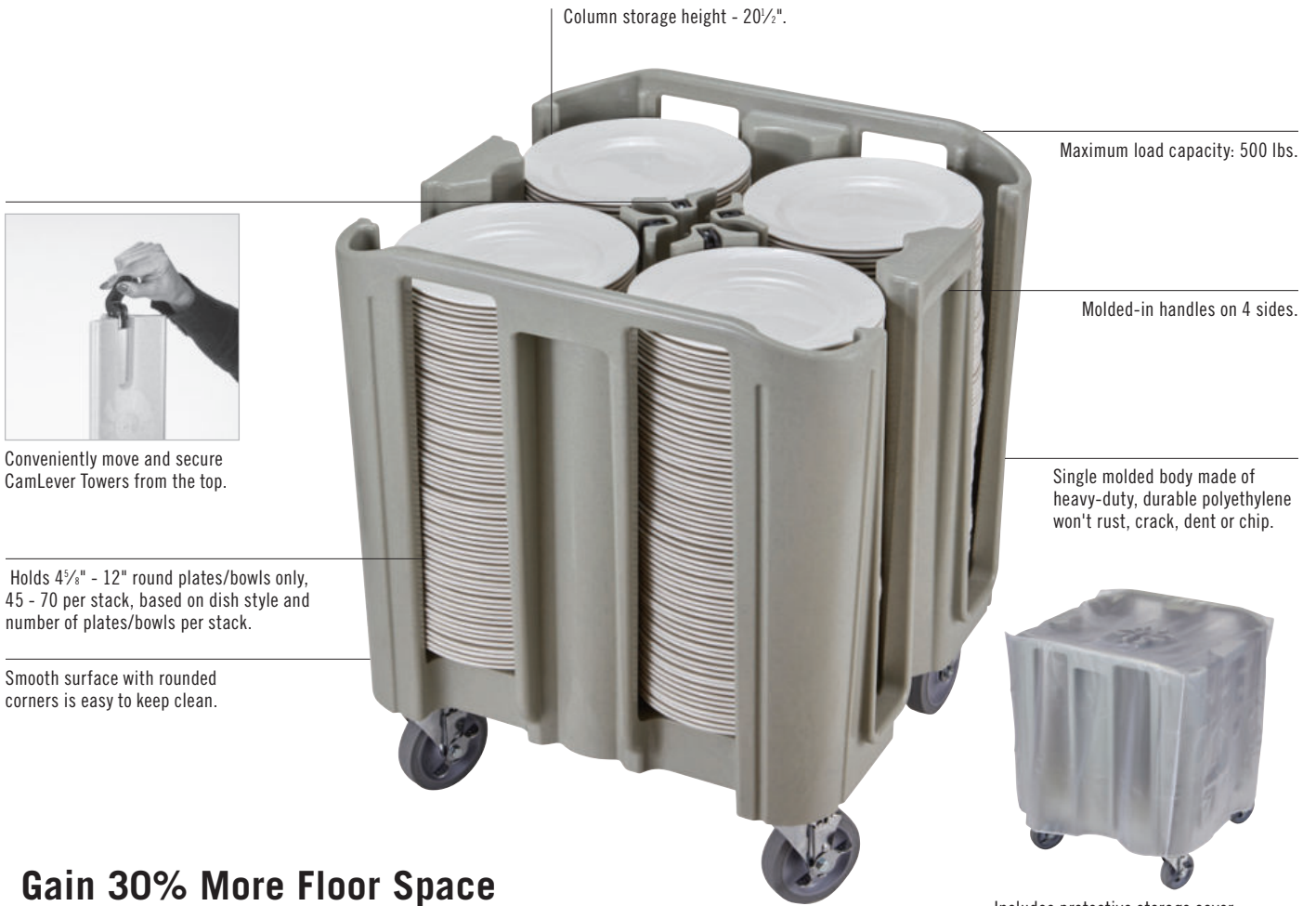

Conveniently move and secure CamLever Towers from the top.

Holds 4⁵/₈" - 12" round plates/bowls only, 45 - 70 per stack, based on dish style and number of plates/bowls per stack.

Smooth surface with rounded corners is easy to keep clean.



Includes protective storage cover with 3" x 5" inventory and/or event identification top pocket.

Gain 30% More Floor Space

Compact Adjustable Dish Caddy compared to Standard Adjustable Dish Caddy S-Series.

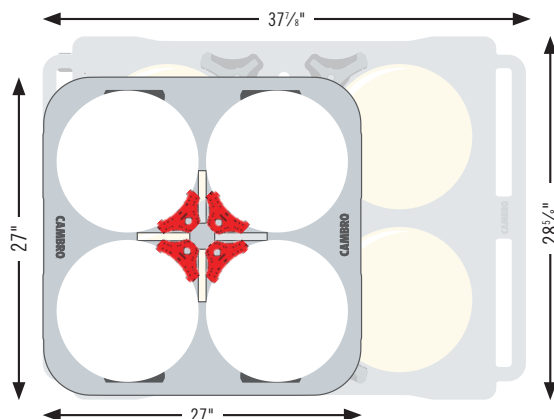

CamLever Tower

ADCSC4
DESCRIPTION:
 CamLever Tower - 4 Each
OVERALL DIMENSIONS W x D x H:
 2⁵/₈" x 4³/₈" x 2³/₂"
LIST PRICE PER CASE: \$ 375.00
Case Pack: 4



Conveniently install additional CamLever Towers to convert the ADCSC to an ADCSC8PKG (8-tower) or an ADCSC12PKG (12-tower) model, holding new dish sizes.

COMPACT ADJUSTABLE DISH CADDY S-SERIES



ADCSC

DESCRIPTION:
Adjustable Dish Caddy, 4 Towers

PLATE SIZE RANGE (ROUNDS):
9" to 12"

OVERALL DIMENSIONS W x D x H:
27" x 27" x 31¼"

LIST PRICE EACH: \$ 1,485.00

Case Pack: 1 Ships in 1 box.



ADCSC8PKG

DESCRIPTION:
Adjustable Dish Caddy, 8 Towers

PLATE SIZE RANGE (ROUNDS):
5¾" to 8¾"

OVERALL DIMENSIONS W x D x H:
27" x 27" x 31¼"

LIST PRICE EACH: \$ 1,860.00

Case Pack: 1 Ships in 2 boxes.



ADCSC12PKG

DESCRIPTION:
Adjustable Dish Caddy, 12 Towers

PLATE SIZE RANGE (ROUNDS):
4⅝" to 5½"

OVERALL DIMENSIONS W x D x H:
27" x 27" x 31¼"

LIST PRICE EACH: \$ 2,230.00

Case Pack: 1 Ships in 3 boxes.

Model: ADCSC, 4 Towers

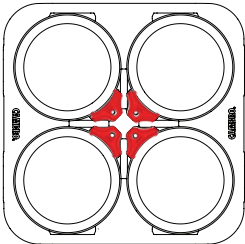

Plate sizes: 9¼" to 12" diam.
Stacks of Plates: 4
Total Capacity: 280

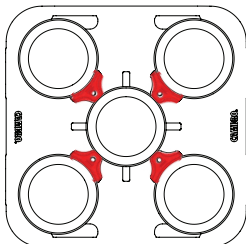

Plate sizes: 9" diam.
Stacks of Plates: 5
Total Capacity: 350

Model: ADCSC8PKG, 8 Towers

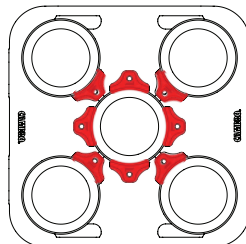

Plate sizes: 7¾" to 8¾" diam.
Stacks of Plates: 5
Total Capacity: 350

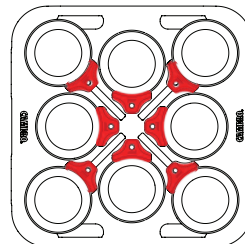

Plate sizes: 5¾" to 7½" diam.
Stacks of Plates: 8
Total Capacity: 560

Model: ADCSC12PKG, 12 Towers

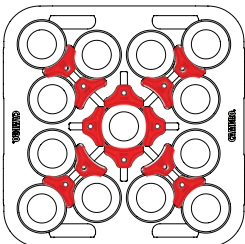

Plate sizes: 4⅝" diam.
Stacks of Plates: 16
Total Capacity: 1,120

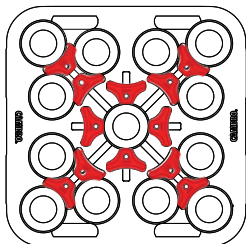

Plate sizes: 4¾" to 5¼" diam.
Stacks of Plates: 13
Total Capacity: 910

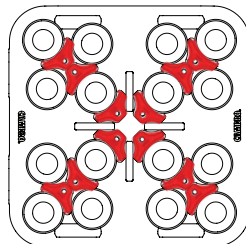

Plate sizes: 5½" diam.
Stacks of Plates: 13
Total Capacity: 910

POKER CHIP "FIXED" NON ADJUSTABLE DISH CADDIES

- Dividers are molded into the body in a standard poker chip design.
- Made of durable polyethylene that protects plates from chipping.
- Rear big wheels and front swivel casters provide smooth maneuvering.
- Open access from two sides for easy loading and unloading.
- Molded-in handles on both ends for easy transporting.

Standard Caddy Colors: Black (110), Slate Blue (401), Dark Brown (131), Granite Gray (191).

Versa Caddy Colors: Black (110), Dark Brown (131), Speckled Gray (480).

Casters: 2, 5" swivel with brakes and two 10" Easy Wheels.

Loading Capacity: 500 lbs.

Vinyl cover included. Not NSF listed.

DCS950 is covered by U.S. Patent D 603,120 S. DCS1125 is covered by U.S. Patent D 625,894.



Standard Dish Caddies



DC575

PLATE SIZE RANGE (ROUNDS):
Up to 5 $\frac{1}{4}$ "

STACKS PER CADDY: 6

PLATES PER STACK: 45-60

OVERALL DIMENSIONS W x L x H:
32 $\frac{3}{8}$ " x 23 $\frac{1}{2}$ " x 31 $\frac{1}{4}$ "

LIST PRICE EACH: \$ 1,435.00

Case Pack: 1



DC700

PLATE SIZE RANGE (ROUNDS):
5 $\frac{7}{8}$ " - 7"

STACKS PER CADDY: 6

PLATES PER STACK: 45-60

OVERALL DIMENSIONS W x L x H:
32 $\frac{3}{8}$ " x 23 $\frac{1}{2}$ " x 31 $\frac{1}{4}$ "

LIST PRICE EACH: \$ 1,435.00

Case Pack: 1



DC825

PLATE SIZE RANGE (ROUNDS):
7 $\frac{7}{8}$ " - 8 $\frac{1}{4}$ "

STACKS PER CADDY: 4

PLATES PER STACK: 45-60

OVERALL DIMENSIONS W x L x H:
28 $\frac{3}{4}$ " x 23 $\frac{3}{4}$ " x 32"

LIST PRICE EACH: \$ 1,435.00

Case Pack: 1



DC1225

PLATE SIZE RANGE (ROUNDS):
11 $\frac{1}{8}$ " - 12 $\frac{1}{4}$ "

STACKS PER CADDY: 4

PLATES PER STACK: 45-60

OVERALL DIMENSIONS W x L x H:
32 $\frac{3}{4}$ " x 27 $\frac{1}{2}$ " x 32"

LIST PRICE EACH: \$ 1,525.00

Case Pack: 1

Versa Dish Caddies



DCS950

PLATE SIZE RANGE (ROUNDS):
8 $\frac{3}{8}$ " - 9 $\frac{1}{2}$ "

PLATE SIZE RANGE (SQUARES):
7 $\frac{1}{4}$ " - 8"

STACKS PER CADDY: 5

PLATES PER STACK: 45-60

OVERALL DIMENSIONS W x L x H:
27" x 30 $\frac{1}{2}$ " x 31 $\frac{1}{4}$ "

LIST PRICE EACH: \$ 1,385.00

Case Pack: 1

InStock Colors: Black (110), Speckled Gray (480).

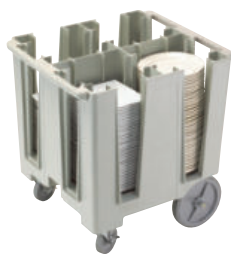

DCS1125

PLATE SIZE RANGE (ROUNDS):
9 $\frac{7}{8}$ " - 11 $\frac{1}{4}$ "

PLATE SIZE RANGE (SQUARES):
8 $\frac{3}{8}$ " - 9 $\frac{1}{2}$ "

STACKS PER CADDY: 4

PLATES PER STACK: 45-60

OVERALL DIMENSIONS W x L x H:
27" x 30 $\frac{1}{2}$ " x 31 $\frac{1}{4}$ "

LIST PRICE EACH: \$ 1,440.00

Case Pack: 1

InStock Colors: Black (110), Speckled Gray (480).



TRAY & DISH CARTS / TRAY & SILVERWARE CART

Tray & Dish Cart

- Open storage compartment holds a wide variety of plates and trays.
- Use with or without detachable cutlery rack. Cutlery rack includes 12 each flatware cylinders.
- Made of easy-to-clean polyethylene that won't rust, peel or corrode.
- Molded-in handles and heavy-duty swivel casters ease maneuvering.

Colors: Slate Blue (401), Coffee Beige (157), Dark Brown (131), Granite Gray (191), Granite Green (192), Black (110).

6" Casters: All swivel, 2 with brake.

Maximum load capacity: 500 lbs.

Vinyl cover included. Not NSF listed.



TDCR12

CODE	DESCRIPTION	DIMENSIONS L x W x H	LIST PRICE EA.
TDCR12	Cart and rack combination	38 $\frac{1}{8}$ " x 22 $\frac{3}{4}$ " x 41 $\frac{1}{4}$ "	\$ 1,890.00
TDC2029*	Cart only	38 $\frac{1}{8}$ " x 22 $\frac{1}{4}$ " x 34 $\frac{1}{4}$ "	1,435.00
CR12	Cutlery rack only	33" x 22 $\frac{3}{4}$ " x 9"	407.00
FWC56	Flatware cylinder	—	6.45

Case Pack: 1 FWC56 Case Pack: 12 *TDC2029 is not available in Black (110).

Adjustable Tray & Dish Cart

- Use to store a wide variety of plates and trays.
- Move two adjustable dividers into position easily to secure trays and plates.
- Made of durable polyethylene

that cushions plates and trays to prevent chipping.

- Easy to clean and won't dent, rust, chip or break.

Colors: Black (110), Slate Blue (401), Coffee Beige (157), Dark Brown (131), Granite Gray (191), Granite Green (192).

6" Casters: All swivel, 2 with brake.

Maximum load capacity: 500 lbs.

Vinyl cover included. Not NSF listed.



TDC30

CODE	DESCRIPTION	EXTERIOR DIMENSIONS L x W x H	NUMBER OF DIVIDERS	PLATES PER COLUMN	TRAYS PER COLUMN	LIST PRICE EA.
TDC30	Adjustable cart	23 $\frac{1}{4}$ " x 38 $\frac{1}{8}$ " x 34 $\frac{1}{2}$ "	2	Approximately 45-60 plates	80 trays: 14" x 18"	\$ 1,885.00

Case Pack: 1

Tray & Silverware Cart

- Use to neatly organize trays and accessories for self-service.
- Includes 4 each 1/3 size and 4 each 1/6 size, 4" deep, clear Camwear® food pans to hold flatware, napkins and non-perishable condiments. 1/3 size, 4" deep holds 100 knives, 100 spoons or 80 forks.

Colors: Slate Blue (401), Coffee Beige (157), Dark Brown (131), Granite Gray (191), Granite Green (192), Black (110).

6" Casters: All swivel, 2 with brake.

Maximum load capacity: 500 lbs.

Vinyl cover included. Not NSF listed.



TC1418

CODE	DESCRIPTION	EXTERIOR DIMENSIONS L x W x H	MAXIMUM TRAY SIZE	TRAY CAPACITY	LIST PRICE EA.
TC1418	Cart with pans	32 $\frac{3}{8}$ " x 21 $\frac{1}{4}$ " x 45 $\frac{1}{2}$ "	14" x 18"	180-200 in two stacks	\$ 1,615.00

Case Pack: 1

KD SERVICE CART AND KD UTILITY CART

- Versatile, durable and economically-priced carts.
- Marine rails and lightly-textured polypropylene shelves keep contents in place.
- Aluminum uprights ensure stability.
- Ships “knocked down” to minimize shipping costs.
- Easy to assemble.

Cart and Shelf Panel Set Colors:
Black (110), Speckled Gray (480).

Trash Container and Silverware Holder Color: Black (110).



camguard
ANTIMICROBIAL HANDLES



Each BC340KD shelf holds one full-sized dish rack or two standard bus boxes.

Marine rails keep contents in place.

Optional shelf panels can be added at time of assembly to enclose three sides. (KD Utility Cart only.)

Sturdy aluminum uprights.

Four powder coated steel swivel casters provide quiet transport and steady maneuvering.

BC340KD

Durable, stain-resistant surface is easy to clean.



BC331KD

CODE	BC340KD	BC331KD
DESCRIPTION	Large Utility Cart	Small Service Cart
CASTER DIA./TYPE	5", 4 swivel, no brake	4", 4 swivel, no brake
OVERALL DIM. L x D x H	40" x 21¼" x 37½"	32⅝" x 16¼" x 38"
SHELF DIM. L x D x H	31½" x 20½" x 11¼"	24⅜" x 15⅝" x 11¼"
LOAD CAPACITY	400 lbs.	300 lbs.
LIST PRICE EACH	\$ 414.00	\$ 279.00

Case Pack: 1 InStock Colors: Black (110), Speckled Gray (480).

Optional Accessories



CODE	BC331KDTC	BC331KDSH	BC340KDP
DESCRIPTION	8 gal. Trash container	2.5 gal. Silverware holder	Single Shelf Panel Set for KD Large Utility Cart 1 side, 2 ends
DIM. W x D x H	13" x 9½" x 22"	13" x 9½" x 7¼"	31⅝" x 17¼" x 11¼"
LIST PRICE EACH	\$ 113.75	\$ 65.50	\$ 113.75

Case Pack: 1

SERVICE CART PRO

A complete line of small, medium, and large service carts, designed to elevate operational efficiency in any type of foodservice operation. Sturdy, strong and durable with a sleek, modern look that rolls easily between front and back of the house.

- Three durable shelves feature raised ridges to protect surface against heat. Shelf surfaces are lightly textured (top only), stain resistant and easy to clean.
- Two molded-in ergonomic handles on each end of the cart are recessed, flush to the body, to save space.
- Middle and bottom shelves have a $\frac{3}{4}$ " (2 cm) raised edge on one side to help keep items in place.
- Choose 4 swivel when maneuvering in and out of tight spaces is needed.

Colors: Black (110), Dark Brown (131), Charcoal Gray (615).

Service Cart PRO and Quick Connect Bins are covered by US Patents D882,203 S, D883,755 S, and D885,003 S.



SC330

EXTRA STABILITY

$1\frac{1}{2}$ " raised rail on top shelf;
 $\frac{3}{4}$ " rail on one side of lower shelves to secure contents.

SPACE MAXIMIZER

Molded-in handles for compact storage, shielded from damage.

MORE OPTIONS

Quick Connect Bins for trash, dirty utensils or extra storage fit securely below handles.

EXTRA TOUGH & SUSTAINABLE

Built for heavy-duty use; resists chips, dents, rust, and stains.



SMOOTH, QUIET MANEUVERING

Heavy-duty, non-marking plate casters. Choose from 2 configurations.

HOT PAN PROTECTION

Shelves with raised cooling ribs to withstand hot pans.

NOTE: Best to cool metal pans to 250°F (121°C) before placing on cart.

SERVICE CART PRO

TOTAL WEIGHT CAPACITY
600 lbs. (272 kg)

200 lbs. (90,7 kg)
PER SHELF



Top Shelf Dimension (L x D Inside Rails)
32⁵/₈" x 19³/₄" (82,9 x 50,1 cm)

Vertical open space between each shelf is 10⁷/₈" (27,6 cm)

Caster Size: 6" x 1¹/₂" (15 x 3,8 cm)

Large

CODE	CASTERS	INTERIOR SHELF DIMENSIONS L x D x H	CART DIMENSIONS L x D x H	UNIT WEIGHT LBS. (KG)	LIST PRICE EA.
SC337	2 Rigid, 2 Swivel with Brake	34 ¹ / ₄ " x 21 ⁵ / ₈ " x 10 ⁷ / ₈ " (87 x 55 x 27,6 cm)	41 ¹ / ₂ " x 23 ⁵ / ₈ " x 37 ¹ / ₄ " (105,4 x 60 x 94,6 cm)	60.5 lbs. (27,4 kg)	\$ 1,390.00
SC337S	4 Swivel, All with Brake	34 ¹ / ₄ " x 21 ⁵ / ₈ " x 10 ⁷ / ₈ " (87 x 55 x 27,6 cm)	41 ¹ / ₂ " x 23 ⁵ / ₈ " x 37 ¹ / ₄ " (105,4 x 60 x 94,6 cm)	62.3 lbs. (28,2 kg)	1,435.00

TOTAL WEIGHT CAPACITY
600 lbs. (272 kg)

200 lbs. (90,7 kg)
PER SHELF



Top Shelf Dimension (L x D Inside Rails)
28¹/₂" x 18" (72,4 x 45,7 cm)

Vertical open space between each shelf is 10⁷/₈" (27,6 cm)

Caster Size: 6" x 1¹/₂" (15 x 3,8 cm)

Medium

CODE	CASTERS	INTERIOR SHELF DIMENSIONS L x D x H	CART DIMENSIONS L x D x H	UNIT WEIGHT LBS. (KG)	LIST PRICE EA.
Open Sides					
SC230	2 Rigid, 2 Swivel with Brake	30 ³ / ₈ " x 21" x 10 ⁷ / ₈ " (77,1 x 53,3 x 27,6 cm)	37 ¹ / ₂ " x 22" x 37 ¹ / ₄ " (95,3 x 55,9 x 94,6 cm)	52 lbs. (23,6 kg)	\$ 1,250.00
SC230S	4 Swivel, All with Brake	30 ³ / ₈ " x 21" x 10 ⁷ / ₈ " (77,1 x 53,3 x 27,6 cm)	37 ¹ / ₂ " x 22" x 37 ¹ / ₄ " (95,3 x 55,9 x 94,6 cm)	53.78 lbs. (24,4 kg)	1,275.00
One Closed Side					
SC330	2 Rigid, 2 Swivel with Brake	30 ³ / ₈ " x 20" x 10 ⁷ / ₈ " (77,1 x 50,8 x 27,6 cm)	37 ¹ / ₂ " x 22" x 37 ¹ / ₄ " (95,3 x 55,9 x 94,6 cm)	59 lbs. (26,7 kg)	1,340.00
SC330S	4 Swivel, All with Brake	30 ³ / ₈ " x 20" x 10 ⁷ / ₈ " (77,1 x 50,8 x 27,6 cm)	37 ¹ / ₂ " x 22" x 37 ¹ / ₄ " (95,3 x 55,9 x 94,6 cm)	60.78 lbs. (27,6 kg)	1,375.00

TOTAL WEIGHT CAPACITY
390 lbs. (176,9 kg)

130 lbs. (59 kg)
PER SHELF



Top Shelf Dimension (L x D Inside Rails)
23⁵/₈" x 14" (60 x 35,6 cm)

Vertical open space between each shelf is 10⁷/₈" (27,6 cm)

Caster Size: 3" x 1¹/₄" (7,6 x 3,2 cm)

Small

CODE	CASTERS	INTERIOR SHELF DIMENSIONS L x D x H	CART DIMENSIONS L x D x H	UNIT WEIGHT LBS. (KG)	LIST PRICE EA.
SC225	2 Rigid, 2 Swivel with Brake	25 ³ / ₄ " x 16 ¹ / ₂ " x 10 ⁷ / ₈ " (65,4 x 41,9 x 27,6 cm)	31 ¹ / ₄ " x 18" x 34" (79,4 x 45,7 x 86,4 cm)	36 lbs. (16,3 kg)	\$ 1,025.00
SC225S	4 Swivel, All with Brake	25 ³ / ₄ " x 16 ¹ / ₂ " x 10 ⁷ / ₈ " (65,4 x 41,9 x 27,6 cm)	31 ¹ / ₄ " x 18" x 34" (79,4 x 45,7 x 86,4 cm)	37.76 lbs. (17,1 kg)	1,045.00

Case Pack: 1 Service Pro Cart Colors: Black (110), Dark Brown (131), Charcoal Gray (615).

Optional Accessories

CODE	DESCRIPTION	EXTERIOR DIM. L x W x H	LIST PRICE EA.
QCSB	Small Quick Connect Bin	16" x 7" x 12 ³ / ₈ "	\$ 118.00
QCTB	Large Quick Connect Bin	16" x 7" x 21 ³ / ₈ "	134.75

Case Pack: 1 Colors: Black (110)



QCTB



QCSB

Optional Quick Connect Bins slide and lock onto molded-in dovetails positioned safely below the handles.

CAMBOX® BUS BOXES

Regal



CODE	1120CBR	1520CBR
DESCRIPTION	Four compartment cutlery box	15" x 20" Cambox
DIM. W x L x H	11 ³ / ₁₆ " x 20 ⁷ / ₁₆ " x 3 ³ / ₄ "	15 ⁵ / ₁₆ " x 19 ¹⁵ / ₁₆ " x 4 ¹⁵ / ₁₆ "
LIST PRICE EACH	\$ 30.80	\$ 31.50

Case Pack: 12 Colors: Black (110), Dark Brown (131).



CODE	21155CBR	21157CBR	1722CBR
DESCRIPTION	15" x 21" x 5" Cambox	15" x 21" x 7" Cambox	17" x 22" Cambox
DIM. W x L x H	15 ¹ / ₄ " x 20 ¹ / ₄ " x 4 ¹⁵ / ₁₆ " (includes handle)	15 ⁵ / ₁₆ " x 20 ³ / ₁₆ " x 6 ¹⁵ / ₁₆ "	16 ⁷ / ₈ " x 21 ¹ / ₈ " x 4 ³ / ₄ "
COVER	2115CBCR	2115CBCR	1722CBCP
LIST PRICE EACH	\$ 36.95	\$ 42.60	\$ 40.95

Case Pack: 12 Colors: Black (110), Dark Brown (131).



Poly



CODE	415CBP	912CBP	1120CBP	1520CBP	1520CBPF*
DESCRIPTION	Cutlery box	Utility box	11" x 20" Cambox	15" x 20" Cambox	15" x 20" Cambox
DIM. W x L x H	4 ¹ / ₁₆ " x 14 ³ / ₁₆ " x 4 ¹ / ₈ "	9 ¹ / ₁₆ " x 12 ¹ / ₁₆ " x 5 ¹ / ₈ "	11 ³ / ₈ " x 20 ⁷ / ₁₆ " x 3 ³ / ₄ "	15 ⁵ / ₁₆ " x 19 ¹⁵ / ₁₆ " x 4 ¹⁵ / ₁₆ "	15 ⁵ / ₁₆ " x 19 ¹⁵ / ₁₆ " x 4 ¹⁵ / ₁₆ "
COVER	—	—	—	1520CBCP	1520CBCP
LIST PRICE EACH	\$ 11.00	\$ 14.90	\$ 23.80	\$ 24.50	\$ 24.50

Case Pack: 12 Colors: Black (110), Dark Brown (131), Light Gray (180).

InStock Color: Light Gray (180). *1520CBPF is identical to 1520CBP except the internal surface is flat.



CODE	1621CBP	21155CBP	21157CBP	1722CBP
DESCRIPTION	15" x 20" Cambox	15" x 21" x 5" Cambox	15" x 21" x 7" Cambox	17" x 22" Cambox
DIM. W x L x H	15 ⁵ / ₈ " x 20 ¹ / ₂ " x 4 ⁷ / ₈ "	15 ¹ / ₄ " x 20 ¹ / ₄ " x 4 ¹⁵ / ₁₆ " (includes handle)	15 ⁵ / ₁₆ " x 20 ³ / ₁₆ " x 6 ¹⁵ / ₁₆ "	16 ⁷ / ₈ " x 21 ¹ / ₈ " x 4 ³ / ₄ "
COVER	—	2115CBCP	2115CBCP	1722CBCP
LIST PRICE EACH	\$ 37.10	\$ 27.65	\$ 29.80	\$ 29.80

Case Pack: 12 Colors: Black (110), Dark Brown (131), Light Gray (180). InStock Color: Light Gray (180).

Covers



CODE	1520CBP	1722CBP	2115CBP	2115CBP
DIM. W x L	16" x 20 ¹ / ₂ "	17 ¹ / ₁₆ " x 22 ³ / ₁₆ "	15 ¹ / ₂ " x 20 ¹ / ₂ "	15 ¹ / ₂ " x 20 ¹ / ₂ "
LIST PRICE EACH	\$ 19.73	\$ 35.48	\$ 19.85	\$ 19.25

Case Pack: 12 Color: White (148).





S H E L V I N G for LIFE®

When we say Shelving for Life, we mean it. All Camshelving® storage systems are designed to withstand the toughest conditions and the harshest environments. With our lifetime warranty against rust and corrosion, only Cambro offers SHELIVING for LIFE™.



Cambro storage and transportation products that support safe food handling.



COMPONENT

Products that meet the NSF International criteria for sanitation and cleanability.



Products that help meet HACCP guidelines.



Fit for food products



Dishwasher Safe



Cadmium-free products



Recyclable polypropylene



Antimicrobial protection permanently molded into shelf plates to inhibit the growth of mold, fungus and bacteria.

Camshelving® is covered under the following U.S. Patents:

D498,664 S, D508,646 S, D512,867 S, D623,929 S, D624,764 S, D648,582 S, D630,935 S, D648,159 S, D651,433 S, D648,160 S, D697,391 S, D727,715 S, D728,347 S, D728,348 S, D707,994 S, D739,989 S, D663,912 S, D736,488 S, D739,989 S, D760,519 S, D841, 273 S, D828, 145 S, D827, 421 S US 6,981,454B2

CAMSHELVING®

S H E L V I N G f o r L I F E®

KEY FEATURES OF ALL CAMSHELVING SERIES



Rust and Corrosion Free

Backed by a lifetime warranty against rust and corrosion. All Camshelving is impervious to harsh chemicals and salt water.

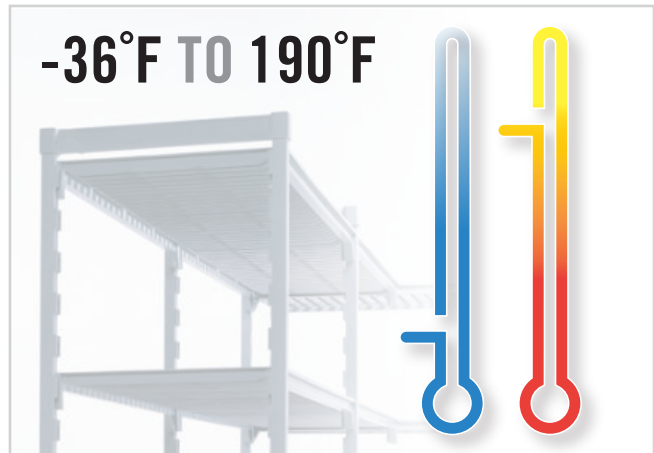

All Environments

Camshelving is designed to withstand all extreme storage applications and temperatures.

- Coolers
- Freezers
- Dry Storage
- Utility

Maximized Space Utilization

Shelving units are designed to be interconnected, without compromising weight-bearing capacity, all while maximizing usable storage space.

Starter Unit

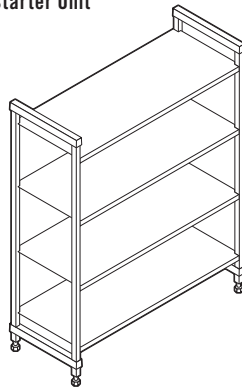

Starter + Add-On Unit

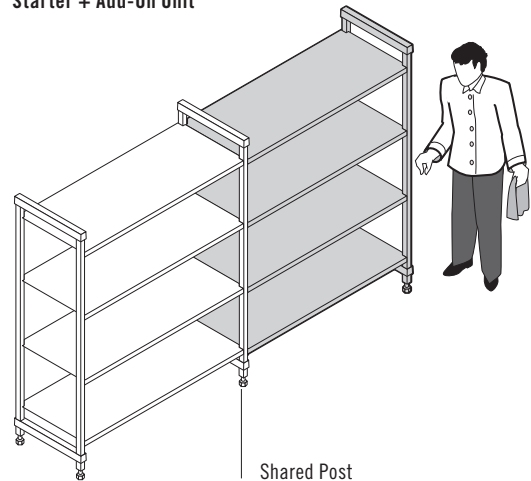

PREMIUM[®] series ELEMENTS[®] XTRA series BASICS[®] PLUS series



Easy to Clean

Camshelving easily wipes clean or shelf plates can go through the dishwasher. Camguard[®] antimicrobial shelf plates inhibit the growth of harmful bacteria and microbes.



Easy to Assemble & Adjust

Units ship with preassembled frames to speed up installation. Each shelf can be easily and independently adjusted.

Corner Unit
Starter + Add-On Unit

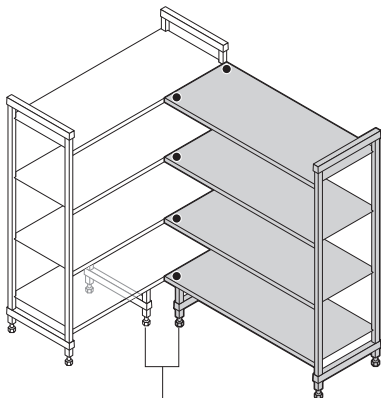

U-Shape Unit
Two Starter Units +
Intermediate Shelves

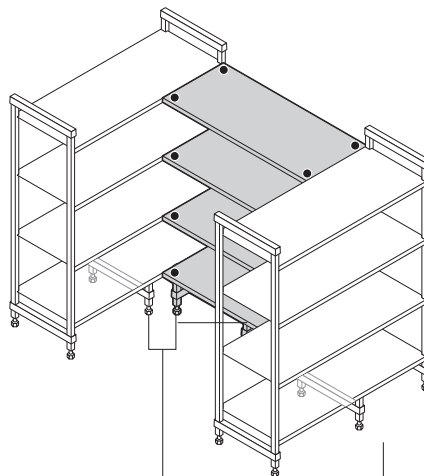

T-Shape Unit
Starter unit + Add-on Unit

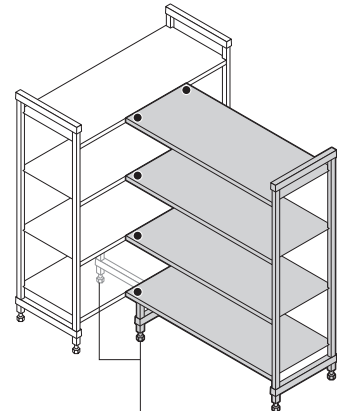

Bottom Shelf
Dunnage Stands

Convert unusable space into continuous, easy-access storage areas with corner connectors. ●
Corner connectors are for use only with shelves 24" - 48" long.

CAMSHELVING® SERIES BUYERS GUIDE

All Camshelving lines offer a lifetime warranty against rust and corrosion for shelf plates, posts and traverses.



	PREMIUM® series	ELEMENTS XTRA® series	BASICS® PLUS series
Shelf Depths	14", 18", 21", 24"	14", 18", 21", 24"	18", 21", 24"
Shelf Lengths	24", 30", 36", 42", 48", 54", 60", 72"	24", 30", 36", 42", 48", 54", 60", 72"	30", 36", 42", 48", 54", 60"
Post Heights	Stationary: 32", 56", 64", 72", 84" Mobile: 35", 59", 67", 75" (includes casters)	Stationary: 30", 64", 72", 84" Mobile: 70¼", 78¼" (includes casters)	Stationary: 64", 72", 84"
Weight-Bearing Capacity (based on 24"- 48" length)	Stationary Unit: 800 lbs. per shelf, 2000 lbs. per unit. Mobile Unit: 750 lbs. per unit. Corner Unit: 400 lbs. per shelf, 1800 lbs. per unit.	Stationary Unit: 800 lbs. per shelf, 2400 lbs. per unit. Mobile Unit: 750 lbs. per unit. Corner Unit: 800 lbs. per shelf, 2400 lbs. per unit.	Stationary Unit: 600 lbs. per shelf, 1800 lbs. per unit. Corner Unit: 300 lbs. per shelf, 1350 lbs. per unit.
Shelf Plates with Camguard® antimicrobial.	Interchangeable with Elements Series.	Interchangeable with Premium Series.	Not interchangeable with Premium or Elements XTRA Series.
Mobility	Available in Mobile and High Density Storage System.	Available in Mobile and High Density Storage System.	Not available.
Assembly	Quickest and easiest to assemble due to molded-in dovetails.	Simple to assemble. Contains separate dovetails that must be attached to the post.	Simple to assemble. Contains separate dovetails that must be attached to the post.
ACCESSORIES			
Bottom Shelf Dunnage Stand	✓	✓	✓
Shelf Rails	✓	✓	✓
Vertical Drying and Storage Cradle (Trays / Cutting Boards / Lids)	✓	✓	✓
Dome Drying and Storage Cradle	✓	✓	✓
Angled Drying and Storage Cradle	✓	✓	✓
Ultimate #10 Can Rack	✓	✓	
Shelf Divider Panel	✓	✓	✓
Shelf Divider Bar (for Food Pans or Food Boxes)	✓	✓	
Single Shelf Sheet Pan/Tray Rack	✓	✓	✓
Single Shelf Security Cage	✓	✓	✓
Full Wrap Security Cage	✓		
Pegboard and Hooks	✓	✓	✓

FREE CAMSHELVING® DESIGN SERVICE



Take the guesswork out of creating your perfect shelving layout. Let our expert shelving consultants prepare a free layout that optimizes your space to create the most storage options.

Here's what you'll get:

- 2D Floor Plan
- 3D Floor Plan
- Itemized product list by room/area
- All within 48 business-day hours

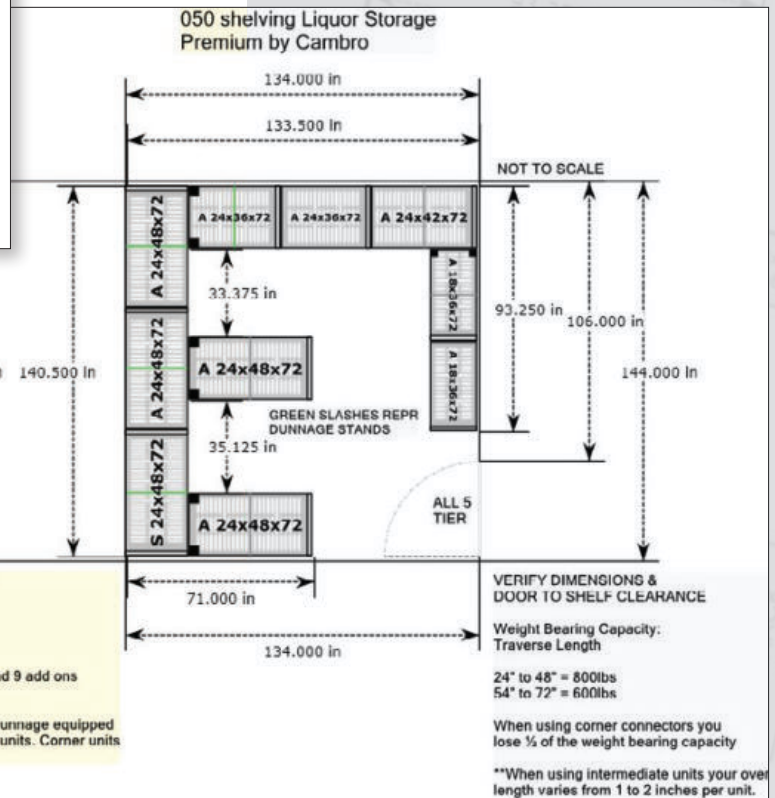

It's Simple! To Get Started, Please Provide:

- Project Name
- Storage Room Type (freezer / cooler)
- Room(s) Dimensions (L x W x H)
- Doorway / Entryway Location & Dimension
- Obstructions (condenser / pipes)
- Additional Preferences / Requirements

Click Here to
**request a FREE
 3D shelving layout**

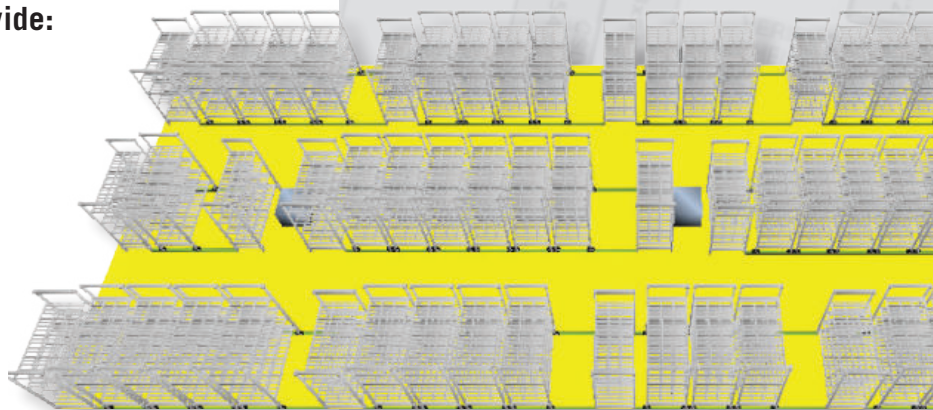

Email shelving@cambro.com or
 call TOLL FREE (877) 737-0663

CAMSHELVING® SERIES OVERALL LENGTH – QUICK REFERENCE GUIDE

Straight Unit: Starter Unit + Add-On Unit with Shared Posts

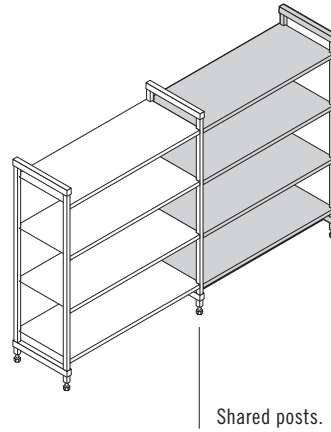
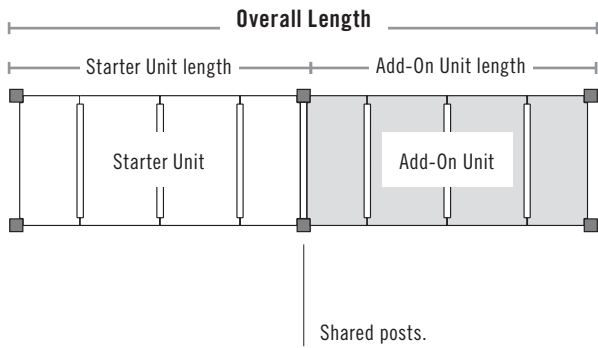

Corner Unit: Starter Unit + Add-On Unit with Corner Connectors

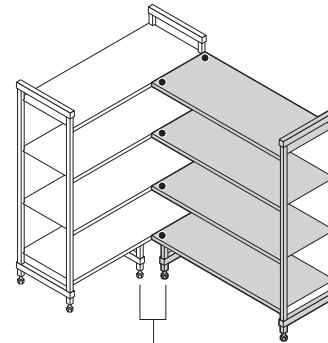
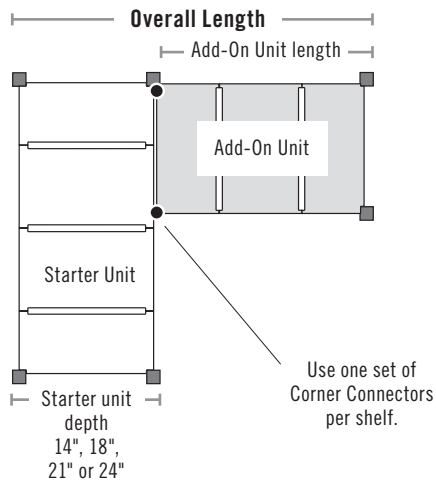

U-Shape Unit: Two Starter Units + Intermediate Shelves with Corner Connectors

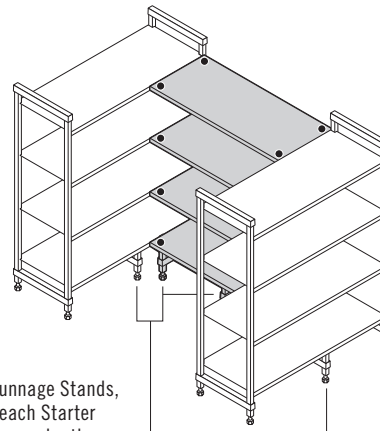
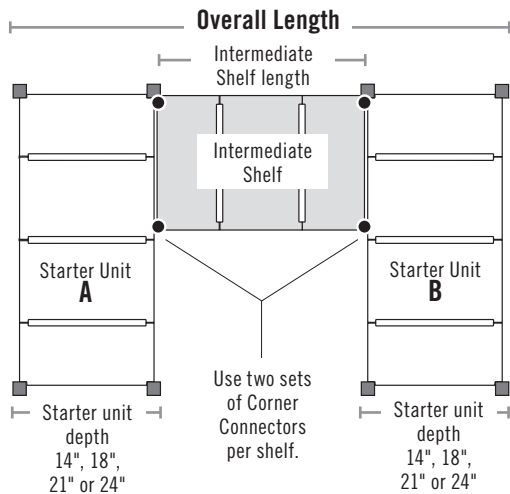

Number of Shelves Per Unit

STATIONARY POST HEIGHT	MOBILE POST HEIGHT	MAXIMUM SHELVES PER UNIT*
30"	—	5
—	27¼"	3
32"	35"	6
56"	59"	12
64"	67" or 70¼"	14
72"	75" or 78¼"	16
84"	—	19

*Based on 4" spacing.

Straight Unit: Starter Unit + Add-On Unit with Shared Posts

PREMIUM / BASICS PLUS SERIES					
STARTER UNIT ACTUAL LENGTH		ADD-ON UNIT ACTUAL LENGTH		OVERALL LENGTH	
24"	+	22¼"	=	46¼"	
30"	+	28¼"	=	58¼"	
36"	+	34¼"	=	70¼"	
42"	+	40¼"	=	82¼"	
48"	+	46¼"	=	94¼"	
54"	+	52¼"	=	106¼"	
60"	+	58¼"	=	118¼"	
72"	+	70¼"	=	142¼"	

24" and 72" are not available in Camshelving Basics Plus Series.

ELEMENTS XTRA SERIES					
STARTER UNIT ACTUAL LENGTH		ADD-ON UNIT ACTUAL LENGTH		OVERALL LENGTH	
24"	+	22"	=	46"	
30"	+	28"	=	58"	
36"	+	34"	=	70"	
42"	+	40"	=	82"	
48"	+	46"	=	94"	
54"	+	52"	=	106"	
60"	+	58"	=	118"	
72"	+	70"	=	142"	

Corner Unit: Starter Unit + Add-On Unit with Corner Connectors

PREMIUM / ELEMENTS XTRA / BASICS PLUS SERIES				
ADD-ON UNIT	ADD-ON UNIT ACTUAL LENGTH		18" STARTER UNIT DEPTH	OVERALL LENGTH
24"	23"	+	18"***	= 41"
30"	29"	+	18"*	= 47"
36"	35"	+	18"*	= 53"
42"	41"	+	18"*	= 59"
48"	47"	+	18"*	= 65"
54"	53"	+	18"	= 71"
60"	59"	+	18"	= 77"

PREMIUM / ELEMENTS XTRA / BASICS PLUS SERIES				
ADD-ON UNIT ACTUAL LENGTH		21" STARTER UNIT DEPTH		OVERALL LENGTH
23"	+	21"***	=	44"
29"	+	21"	=	50"
35"	+	21"	=	56"
41"	+	21"	=	62"
47"	+	21"	=	68"
53"	+	21"	=	74"
59"	+	21"	=	80"

PREMIUM / ELEMENTS XTRA / BASICS PLUS SERIES				
ADD-ON UNIT ACTUAL LENGTH		24" STARTER UNIT DEPTH		OVERALL LENGTH
23"	+	24"***	=	47"
29"	+	24"	=	53"
35"	+	24"	=	59"
41"	+	24"	=	65"
47"	+	24"	=	71"
53"	+	24"	=	77"
59"	+	24"	=	83"

24" unit not available in Camshelving Basics Plus Series.

*Elements XTRA Series only **Actual depth.

U-Shape Unit: Two Starter Units + Intermediate Shelves with Corner Connectors

PREMIUM / ELEMENTS XTRA / BASICS PLUS SERIES				
INTERMEDIATE SHELF	INTERMEDIATE SHELF ACTUAL LENGTH		18" DEPTH STARTER UNIT A+B	OVERALL LENGTH
36"	34"	+	36"*	= 70"
42"	40"	+	36"*	= 76"
48"	46"	+	36"*	= 82"
54"*	52"	+	36"	= 88"
60"*	58"	+	36"	= 94"

PREMIUM / ELEMENTS XTRA / BASICS PLUS SERIES				
INTERMEDIATE SHELF ACTUAL LENGTH		21" DEPTH STARTER UNIT A+B		OVERALL LENGTH
34"	+	42"*	=	76"
40"	+	42"*	=	82"
46"	+	42"*	=	88"
52"	+	42"	=	94"
60"	+	42"	=	102"

PREMIUM / ELEMENTS XTRA / BASICS PLUS SERIES				
INTERMEDIATE SHELF ACTUAL LENGTH		24" DEPTH STARTER UNIT A+B		OVERALL LENGTH
34"	+	48"*	=	82"
40"	+	48"*	=	88"
46"	+	48"*	=	94"
52"	+	48"	=	100"
60"	+	48"	=	108"

*Elements XTRA Series only **Actual depth.

*Actual depth.

CAMSHELVING PREMIUM[®] series

STATIONARY | MOBILE | HIGH DENSITY

- Posts and traverses have a steel core and smooth polypropylene exterior for superior strength and durability.
- Traverse dovetails are molded into posts every 4".
- Polypropylene shelf plates with permanent, molded-in Camguard[®], an antimicrobial technology that inhibits the growth of mold, fungus, and bacteria.
- Sturdy reinforced threaded nylon foot adjusts easily to level units.
- Withstands storage temperatures from -36°F to 190°F.
- Lifetime warranty against rust and corrosion.

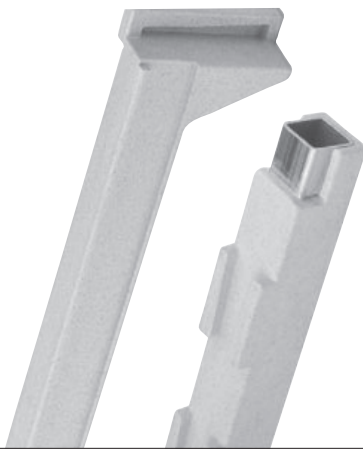

camguard
ANTIMICROBIAL SHELF PLATES



COMPONENT



Post Connectors, Corner Connectors, Floor Fastener, Wall Fastener, Identification Tags, Full Wrap Security Cage, Single Shelf Security Cage, Ultimate #10 Can Rack, Shelf Rails, Shelf Divider Bars, High Density Track and Extension Kits are not NSF Listed.

CAMSHELVING PREMIUM® SERIES

Ship complete in 1 box. Includes factory assembled post frames for quicker assembly.

*Units ship in separate post kit (unassembled) and shelf kit cartons due to overall weight.

**Sold Separately as shelf kits & post kits only.

Stationary Unit Sizes

4 Depths		8 Lengths			5 Heights		
14"***	18"	24"	30"	36"	32"	56"	64"
21"	24"	42"	48"	54"	72"	84"*	
		60"	72"*				

Standard Mobile

3 Depths			3 Lengths			4 Heights		
18"	21"	24"	36"	42"	48"	35"	59"	67"
						75"		

High Density Mobile

3 Depths			5 Lengths			2 Heights	
18"*	21"	24"	36"	42"	48"	67"	75"
			54"	60"			

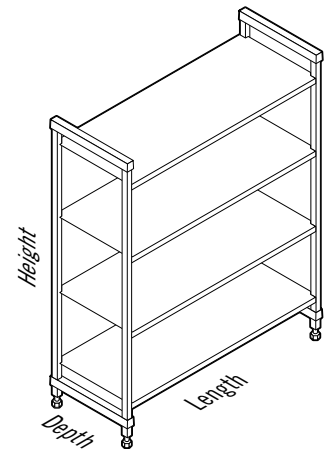

Weight Bearing Capacity

Weight must be evenly distributed across the entire shelf.

		UNIT LENGTH 24" – 48"	UNIT LENGTH 54" – 72"
SINGLE UNIT	Unit only	2,000 lbs.	2,000 lbs.
	Shelf only	800	600
	Unit with dunnage stand*	2,400	2,300
	Bottom shelf with dunnage stand*	1,200	900
CORNER UNIT*** With 2 Dunnage Stands required	Unit only	1,800	—
	Shelf only	400	—
	Bottom shelf with dunnage stands*	600	—
MOBILE UNIT	Unit only**	900	—

*Dunnage Stands add stability and increase weight bearing capacity on bottom shelf only. Highly recommended for Starter Units 54" and longer, all Corner Units, U-Shape Units and units specified for heavier loads.

**Due to the weight bearing capacity of casters, maximum weight load on an entire Mobile Unit is 900 lbs.

***Corner connectors are for use only with shelves 24" - 48" long.



PREMIUM
SERIES

V4 4-SHELF VENTED UNITS

64"
HEIGHT

Starter units include 2 factory assembled post kits and shelves. Add-on units include 1 factory assembled post kit and shelves. Units ship complete in 1 box.

Starter

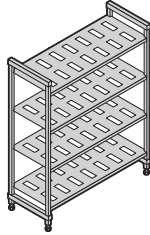

Add-On

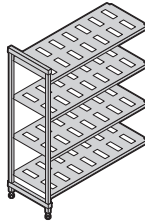

18"
DEPTH

DIMENSIONS D x L x H	CODE	LIST PRICE EA.	CODE	LIST PRICE EA.
18" x 24" x 64"	CPU182464V4	\$ 670.00	CPA182464V4	\$ 520.00
18" x 30" x 64"	CPU183064V4	760.00	CPA183064V4	610.00
18" x 36" x 64"	CPU183664V4	810.00	CPA183664V4	655.00
18" x 42" x 64"	CPU184264V4	905.00	CPA184264V4	755.00
18" x 48" x 64"	CPU184864V4	940.00	CPA184864V4	790.00
18" x 54" x 64"	CPU185464V4	1,040.00	CPA185464V4	885.00
18" x 60" x 64"	CPU186064V4	1,100.00	CPA186064V4	950.00
18" x 72" x 64"	CPU187264V4PKG	1,235.00	CPA187264V4PKG	1,080.00

PKG units ship same as 84" units.

21"
DEPTH

21" x 24" x 64"	CPU212464V4	\$ 725.00	CPA212464V4	\$ 570.00
21" x 30" x 64"	CPU213064V4	820.00	CPA213064V4	665.00
21" x 36" x 64"	CPU213664V4	880.00	CPA213664V4	730.00
21" x 42" x 64"	CPU214264V4	990.00	CPA214264V4	835.00
21" x 48" x 64"	CPU214864V4	1,035.00	CPA214864V4	880.00
21" x 54" x 64"	CPU215464V4	1,140.00	CPA215464V4	990.00
21" x 60" x 64"	CPU216064V4	1,220.00	CPA216064V4	1,065.00
21" x 72" x 64"	CPU217264V4PKG	1,370.00	CPA217264V4PKG	1,220.00

PKG units ship same as 84" units.

24"
DEPTH

24" x 24" x 64"	CPU242464V4	\$ 735.00	CPA242464V4	\$ 585.00
24" x 30" x 64"	CPU243064V4	840.00	CPA243064V4	680.00
24" x 36" x 64"	CPU243664V4	905.00	CPA243664V4	750.00
24" x 42" x 64"	CPU244264V4	1,000.00	CPA244264V4	845.00
24" x 48" x 64"	CPU244864V4	1,070.00	CPA244864V4	915.00
24" x 54" x 64"	CPU245464V4	1,155.00	CPA245464V4	1,000.00
24" x 60" x 64"	CPU246064V4	1,230.00	CPA246064V4	1,070.00
24" x 72" x 64"	CPU247264V4PKG	1,390.00	CPA247264V4PKG	1,240.00

PKG units ship same as 84" units.

PREMIUM
SERIES

V4 4-SHELF VENTED UNITS

72"
HEIGHT

Starter units include 2 factory assembled post kits and shelves. Add-on units include 1 factory assembled post kit and shelves. Units ship complete in 1 box.

Starter

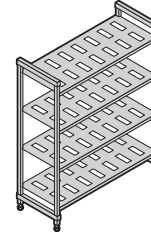

Add-On

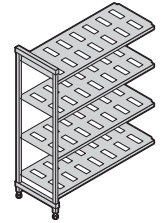

DIMENSIONS D x L x H	CODE	LIST PRICE EA.	CODE	LIST PRICE EA.
18" x 24" x 72"	CPU182472V4	\$ 675.00	CPA182472V4	\$ 525.00
18" x 30" x 72"	CPU183072V4	765.00	CPA183072V4	610.00
18" x 36" x 72"	CPU183672V4	815.00	CPA183672V4	660.00
18" x 42" x 72"	CPU184272V4	910.00	CPA184272V4	760.00
18" x 48" x 72"	CPU184872V4	945.00	CPA184872V4	790.00
18" x 54" x 72"	CPU185472V4	1,050.00	CPA185472V4	890.00
18" x 60" x 72"	CPU186072V4	1,110.00	CPA186072V4	955.00
18" x 72" x 72"	CPU187272V4PKG	1,240.00	CPA187272V4PKG	1,085.00

21" x 24" x 72"	CPU212472V4	\$ 730.00	CPA212472V4	\$ 580.00
21" x 30" x 72"	CPU213072V4	825.00	CPA213072V4	670.00
21" x 36" x 72"	CPU213672V4	885.00	CPA213672V4	730.00
21" x 42" x 72"	CPU214272V4	995.00	CPA214272V4	840.00
21" x 48" x 72"	CPU214872V4	1,040.00	CPA214872V4	885.00
21" x 54" x 72"	CPU215472V4	1,145.00	CPA215472V4	995.00
21" x 60" x 72"	CPU216072V4	1,230.00	CPA216072V4	1,070.00
21" x 72" x 72"	CPU217272V4PKG	1,375.00	CPA217272V4PKG	1,220.00

24" x 24" x 72"	CPU242472V4	\$ 740.00	CPA242472V4	\$ 590.00
24" x 30" x 72"	CPU243072V4	845.00	CPA243072V4	680.00
24" x 36" x 72"	CPU243672V4	910.00	CPA243672V4	755.00
24" x 42" x 72"	CPU244272V4	1,005.00	CPA244272V4	850.00
24" x 48" x 72"	CPU244872V4	1,075.00	CPA244872V4	915.00
24" x 54" x 72"	CPU245472V4	1,175.00	CPA245472V4	1,005.00
24" x 60" x 72"	CPU246072V4	1,240.00	CPA246072V4	1,075.00
24" x 72" x 72"	CPU247272V4PKG	1,395.00	CPA247272V4PKG	1,240.00

Color: Speckled Gray (480).

PREMIUM
SERIES

V5PKG 5-SHELF VENTED UNITS

84"
HEIGHT

Due to the unit weight, 84" units ship in separate boxes. Starter units include 2 post kits and 1 box of shelves. Add on units include 1 post kit and 1 box of shelves. Post kits require assembly.

Starter

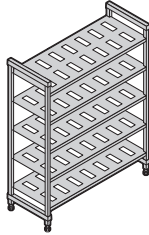

Add-On

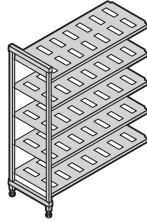

18"
DEPTH

DIMENSIONS D x L x H	CODE	LIST PRICE EA.	CODE	LIST PRICE EA.
18" x 24" x 84"	CPU182484V5PKG	\$ 815.00	CPA182484V5PKG	\$ 645.00
18" x 30" x 84"	CPU183084V5PKG	930.00	CPA183084V5PKG	750.00
18" x 36" x 84"	CPU183684V5PKG	990.00	CPA183684V5PKG	810.00
18" x 42" x 84"	CPU184284V5PKG	1,110.00	CPA184284V5PKG	935.00
18" x 48" x 84"	CPU184884V5PKG	1,145.00	CPA184884V5PKG	975.00
18" x 54" x 84"	CPU185484V5PKG	1,270.00	CPA185484V5PKG	1,095.00
18" x 60" x 84"	CPU186084V5PKG	1,360.00	CPA186084V5PKG	1,185.00
18" x 72" x 84"	CPU187284V5PKG	1,525.00	CPA187284V5PKG	1,350.00

21"
DEPTH

21" x 24" x 84"	CPU212484V5PKG	\$ 880.00	CPA212484V5PKG	\$ 695.00
21" x 30" x 84"	CPU213084V5PKG	1,000.00	CPA213084V5PKG	820.00
21" x 36" x 84"	CPU213684V5PKG	1,075.00	CPA213684V5PKG	900.00
21" x 42" x 84"	CPU214284V5PKG	1,210.00	CPA214284V5PKG	1,035.00
21" x 48" x 84"	CPU214884V5PKG	1,265.00	CPA214884V5PKG	1,085.00
21" x 54" x 84"	CPU215484V5PKG	1,410.00	CPA215484V5PKG	1,230.00
21" x 60" x 84"	CPU216084V5PKG	1,500.00	CPA216084V5PKG	1,315.00
21" x 72" x 84"	CPU217284V5PKG	1,690.00	CPA217284V5PKG	1,510.00

24"
DEPTH

24" x 24" x 84"	CPU242484V5PKG	\$ 900.00	CPA242484V5PKG	\$ 715.00
24" x 30" x 84"	CPU243084V5PKG	1,030.00	CPA243084V5PKG	840.00
24" x 36" x 84"	CPU243684V5PKG	1,110.00	CPA243684V5PKG	920.00
24" x 42" x 84"	CPU244284V5PKG	1,235.00	CPA244284V5PKG	1,050.00
24" x 48" x 84"	CPU244884V5PKG	1,310.00	CPA244884V5PKG	1,125.00
24" x 54" x 84"	CPU245484V5PKG	1,425.00	CPA245484V5PKG	1,245.00
24" x 60" x 84"	CPU246084V5PKG	1,510.00	CPA246084V5PKG	1,330.00
24" x 72" x 84"	CPU247284V5PKG	1,715.00	CPA247284V5PKG	1,530.00

PREMIUM
SERIES

V4 4-SHELF VENTED MOBILE UNITS

Mobile starter units include 2 factory assembled mobile post kits, shelves and 4 premium swivel casters with total locking brake. Units ship complete in 1 box.

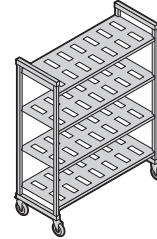

67"
HEIGHT

18"
DEPTH

CODE	DIMENSIONS D x L x H*	LIST PRICE EA.
CPMU183667V4	18" x 36" x 67"	\$ 1,195.00
CPMU184267V4	18" x 42" x 67"	1,295.00
CPMU184867V4	18" x 48" x 67"	1,330.00

21"
DEPTH

CPMU213667V4	21" x 36" x 67"	\$ 1,265.00
CPMU214267V4	21" x 42" x 67"	1,380.00
CPMU214867V4	21" x 48" x 67"	1,425.00

24"
DEPTH

CPMU243667V4	24" x 36" x 67"	\$ 1,295.00
CPMU244267V4	24" x 42" x 67"	1,390.00
CPMU244867V4	24" x 48" x 67"	1,450.00

75"
HEIGHT

18"
DEPTH

CODE	DIMENSIONS D x L x H*	LIST PRICE EA.
CPMU183675V4	18" x 36" x 75"	\$ 1,200.00
CPMU184275V4	18" x 42" x 75"	1,300.00
CPMU184875V4	18" x 48" x 75"	1,335.00

21"
DEPTH

CPMU213675V4	21" x 36" x 75"	\$ 1,270.00
CPMU214275V4	21" x 42" x 75"	1,385.00
CPMU214875V4	21" x 48" x 75"	1,430.00

24"
DEPTH

CPMU243675V4	24" x 36" x 75"	\$ 1,300.00
CPMU244275V4	24" x 42" x 75"	1,395.00
CPMU244875V4	24" x 48" x 75"	1,455.00

CAMSHELVING PREMIUM® SERIES

Corner Connectors

Unique patented design ensures maximum shelf space utilization. Use 1 set per shelf to connect starter and add-on units in corners. Connect 4 or 5 intermediate shelves between 2 starter units (2 sets required per shelf). Available as a single set or 8 or 10 set packs.

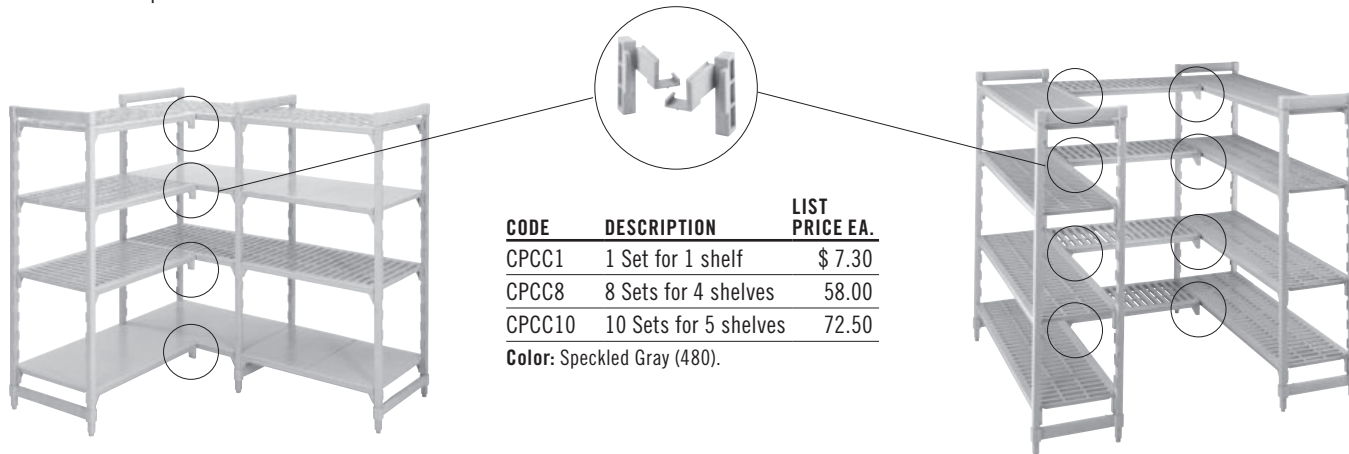

CODE	DESCRIPTION	LIST PRICE EA.
CPCC1	1 Set for 1 shelf	\$ 7.30
CPCC8	8 Sets for 4 shelves	58.00
CPCC10	10 Sets for 5 shelves	72.50

Color: Speckled Gray (480).

Bottom Shelf Dunnage Stands

Increase weight bearing capacity on bottom shelf only. Add to any shelf length. Highly recommended for starter units 54" and longer and all corner units, intermediate units and units specified for heavier load volume on and off bottom shelves.

Bottom Shelf with Dunnage Stand

UNIT LENGTH	WEIGHT BEARING
Standard Unit	
24"- 48"	1,200 lbs.
54"- 72"	900
Corner Unit with 2 Dunnage Stands	
24"- 48"	600

CODE	DIMENSIONS D x H	LIST PRICE EA.
Dunnage Stand - Low		
CSDS14H6	14" x 6½"	\$ 69.00
CSDS18H6	18" x 6½"	71.25
CSDS21H6	21" x 6½"	73.00
CSDS24H6	24" x 6½"	74.75
Dunnage Stand - Tall		
CSDS14H10	14" x 10½"	\$ 75.25
CSDS18H10	18" x 10½"	77.50
CSDS21H10	21" x 10½"	79.25
CSDS24H10	24" x 10½"	81.00

Case Pack: 1 Color: Speckled Gray (480).

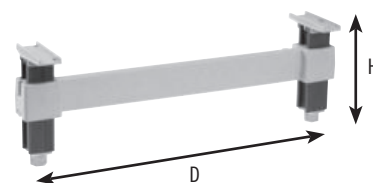

Shelf Traverses

Available in single or double packs. Use a single set to add an open shelf for divider bars or drying racks. Add single traverses onto back posts for extra support when placing rolling equipment under the first shelf.

LENGTH	SINGLE PACK CODE*	LIST PRICE EA.	DOUBLE PACK CODE**	LIST PRICE EA.
24"	CPTR24	\$ 42.10	CPTR242PK	\$ 73.75
30"	CPTR30	45.50	CPTR302PK	79.75
36"	CPTR36	49.55	CPTR362PK	86.75
42"	CPTR42	53.00	CPTR422PK	94.75
48"	CPTR48	57.75	CPTR482PK	103.25
54"	CPTR54	62.75	CPTR542PK	112.00
60"	CPTR60	67.75	CPTR602PK	120.50
72"	CPTR72	73.75	—	—

*Case Pack: 1 **Case Pack: 2 Color: Speckled Gray (480).



HIGH DENSITY STORAGE FLOOR TRACK SYSTEM

Maximize storage capacity by creating storage aisles in all available space. This simple system is composed of stationary starter units anchored to a raised floor track system at both ends with high density mobile units installed in between. Easy to install track requires no drilling or gluing.



Increases Storage Capacity Up To

50%

High Density Mobile Units are available with factory assembled post kits, vented or solid shelves and high density casters and bumpers. Full track and extension kits ship complete with required hardware. Stationary Starter Units are required to anchor the system at both ends. Choose from a wide selection of sizes with 4 or 5 shelves to maximize storage space. (see Premium Series spec pages).

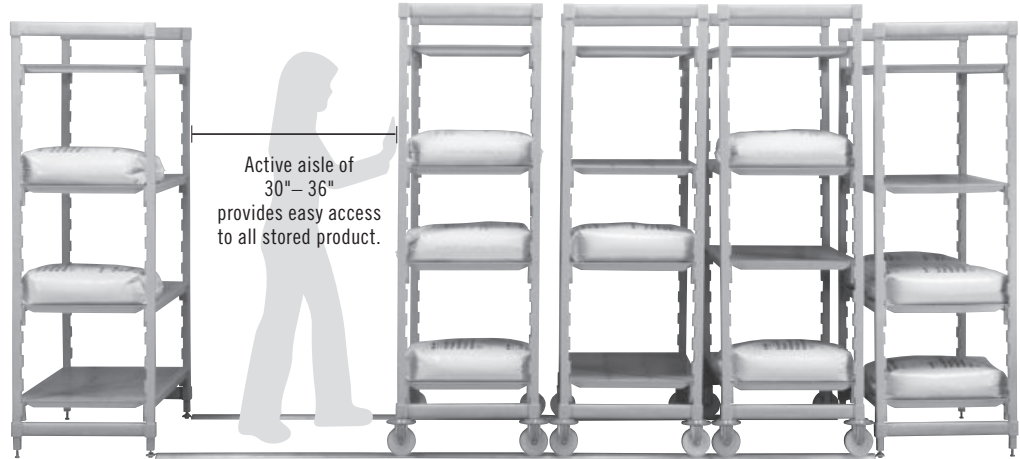

Stationary Unit*

High Density Mobile Units

Stationary Unit

Raised Floor Track provides a smooth and level surface to easily roll mobile units. Raised track ensures dirt will not get trapped and is easy to clean. Aluminum track and stainless steel hardware are rust resistant.

*It is recommended to use a stationary unit for every 15' of track to further stabilize the system.



Grooved casters roll easily and securely on raised track.



Raised track connects easily to the bottom of a stationary unit that works as a system anchor. No bolts, no glue or drilling into the floor are required. Easy and fast set up.

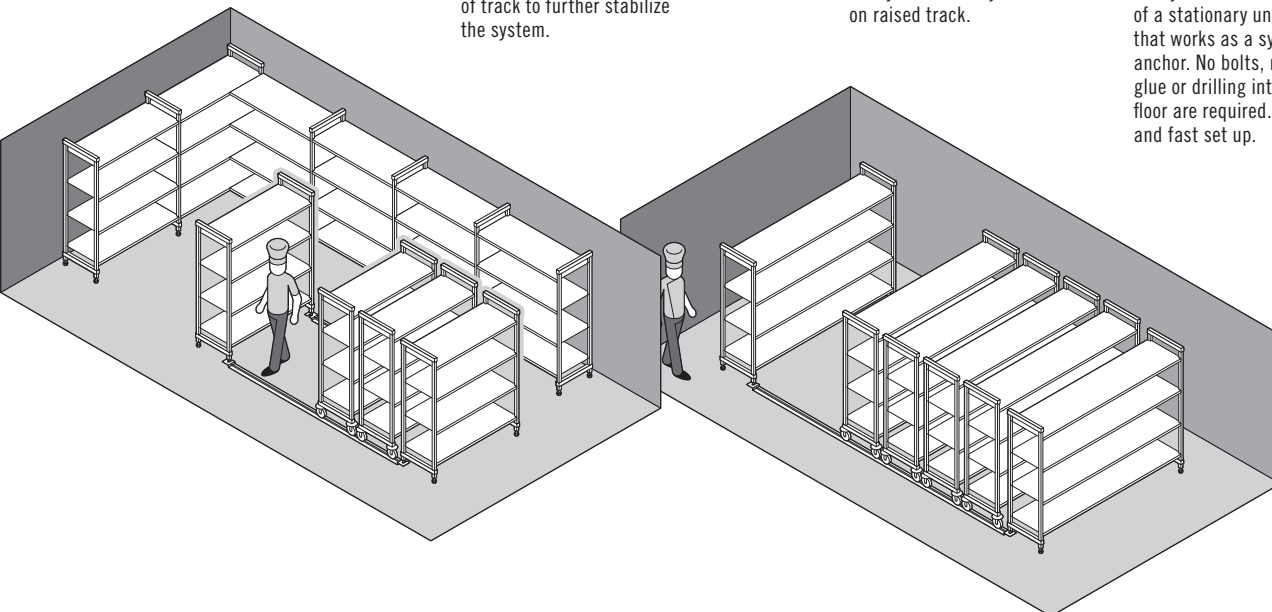

V4

4-SHELF VENTED HIGH DENSITY MOBILE UNITS

S4

4-SHELF SOLID HIGH DENSITY MOBILE UNITS

Units include 2 factory assembled mobile post kits, 4 shelves, 4 high density casters and 4 high density bumpers. Units ship complete in 1 box.

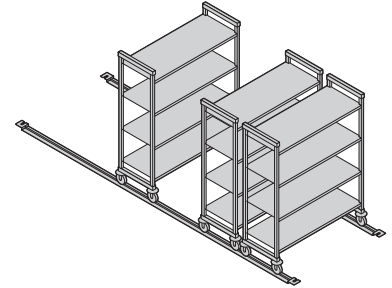
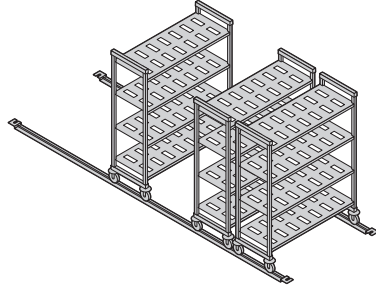

67"
HEIGHT

21"
DEPTH

24"
DEPTH

75"
HEIGHT

21"
DEPTH

24"
DEPTH

CODE	DIMENSIONS D x L x H*	LIST PRICE EA.
CPHU213667V4	21" x 36" x 67"	\$ 1,295.00
CPHU214267V4	21" x 42" x 67"	1,410.00
CPHU214867V4	21" x 48" x 67"	1,445.00
CPHU215467V4	21" x 54" x 67"	1,560.00
CPHU216067V4	21" x 60" x 67"	1,635.00

CPHU243667V4	24" x 36" x 67"	\$ 1,315.00
CPHU244267V4	24" x 42" x 67"	1,420.00
CPHU244867V4	24" x 48" x 67"	1,490.00
CPHU245467V4	24" x 54" x 67"	1,575.00
CPHU246067V4	24" x 60" x 67"	1,645.00

CODE	DIMENSIONS D x L x H*	LIST PRICE EA.
CPHU213675V4	21" x 36" x 75"	\$ 1,305.00
CPHU214275V4	21" x 42" x 75"	1,415.00
CPHU214875V4	21" x 48" x 75"	1,450.00
CPHU215475V4	21" x 54" x 75"	1,565.00
CPHU216075V4	21" x 60" x 75"	1,645.00

CPHU243675V4	24" x 36" x 75"	\$ 1,325.00
CPHU244275V4	24" x 42" x 75"	1,425.00
CPHU244875V4	24" x 48" x 75"	1,495.00
CPHU245475V4	24" x 54" x 75"	1,585.00
CPHU246075V4	24" x 60" x 75"	1,655.00

CODE	DIMENSIONS D x L x H*	LIST PRICE EA.
CPHU213667S4	21" x 36" x 67"	\$ 1,325.00
CPHU214267S4	21" x 42" x 67"	1,440.00
CPHU214867S4	21" x 48" x 67"	1,495.00
CPHU215467S4	21" x 54" x 67"	1,605.00
CPHU216067S4	21" x 60" x 67"	1,685.00

CPHU243667S4	24" x 36" x 67"	\$ 1,365.00
CPHU244267S4	24" x 42" x 67"	1,455.00
CPHU244867S4	24" x 48" x 67"	1,540.00
CPHU245467S4	24" x 54" x 67"	1,635.00
CPHU246067S4	24" x 60" x 67"	1,710.00

CODE	DIMENSIONS D x L x H*	LIST PRICE EA.
CPHU213675S4	21" x 36" x 75"	\$ 1,330.00
CPHU214275S4	21" x 42" x 75"	1,445.00
CPHU214875S4	21" x 48" x 75"	1,500.00
CPHU215475S4	21" x 54" x 75"	1,615.00
CPHU216075S4	21" x 60" x 75"	1,690.00

CPHU243675S4	24" x 36" x 75"	\$ 1,370.00
CPHU244275S4	24" x 42" x 75"	1,465.00
CPHU244875S4	24" x 48" x 75"	1,545.00
CPHU245475S4	24" x 54" x 75"	1,645.00
CPHU246075S4	24" x 60" x 75"	1,715.00

Full Track and Extension Kits

Aluminum raised track kits and track extensions ship complete in 1 box. Each kit includes all stainless steel hardware necessary to complete a floor installation.

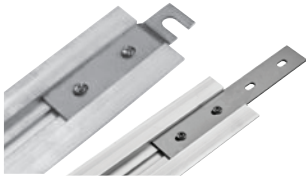
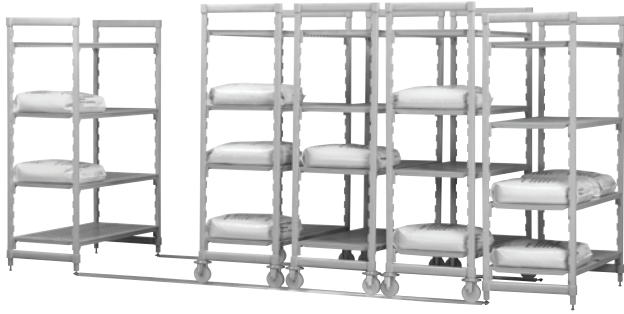

It is highly recommended to install a stationary starter unit every 15' of track to further stabilize the system.

CODE	DESCRIPTION	CASE PACK	LIST PRICE EA.
Full Track Kit			
CSMHDTK10	10' Track for 3 Mobile Units*	1	\$ 835.00
CSMHDTK12	12' Track for 4 Mobile Units*	1	965.00
CSMHDTK145	14.5' Track for 5 Mobile Units*	1	1,080.00
Track Extension Kit			
CSMHDTKE4	4.5' Track Extension	1	314.00
CSMHDTKE5	5' Track Extension	1	336.00
CSMHDTKE6	6' Track Extension	1	402.00

Color: Silver (000). *Based on 24" deep mobile units.

High Density Caster with Donut Bumper



CODE	SIZE	LIST PRICE EA.
CPMCHD	5"	\$ 72.50
Case Pack: 2 Color: Gray (000).		





Golden Grill
PREMIUM
CEREAL

CEREAL

11MAY 6GF 1443

Phase
PREMIUM
ORANGE JUICE

Phase
PREMIUM
ORANGE JUICE

CONDENSED

CONDENSED

CONDENSED

CONDENSED

CONDENSED

CONDENSED

CONDENSED

CONDENSED

CONDENSED

CONDENSED

CONDENSED

CONDENSED

CAMSHELVING

ELEMENTS® XTRA

series

STATIONARY | MOBILE | HIGH DENSITY | UNDERCOUNTER

- Posts and traverses made of a revolutionary, extremely strong composite material with a smooth, easy to clean surface. Posts now have notches on the inside only for installing traverse dovetails.
- Removable polypropylene shelf plates with permanent, molded-in Camguard®, an antimicrobial technology that inhibits the growth of mold, fungus, and bacteria.
- Sturdy reinforced threaded nylon foot adjusts easily to level units.
- Withstands storage temperatures from -36°F to 190°F.
- Lifetime warranty against rust and corrosion.
- NEW patented post connector locks in place onto the wraparound collar wedge for solid, enhanced stability.
- NEW universal traverses can now be installed every 4" on both stationary and mobile units with new single snap on dovetail.
- NEW two piece, heavy-duty corner connectors featuring a "clasp" design offer zero loss of weight bearing in corners and greater weight bearing on middle shelves installed between units.



camguard
ANTIMICROBIAL SHELF PLATES



COMPONENT

Post Connectors, Corner Connectors, Floor Fastener, Wall Fastener, Identification Tags, Single Shelf Security Cage, Ultimate #10 Can Rack, and Shelf Divider Bars are not NSF Listed.

CAMSHELVING ELEMENTS® EXTRA SERIES

Ship complete in 1 box. Includes factory assembled post frames for quicker assembly.

*Sold separately as shelf kits and post kits only.

Stationary Unit Sizes

4 Depths		8 Lengths			3 Heights		
14"*	18"	24"	30"	36"	64"	72"	84"
21"	24"	42"	48"	54"			
		60"	72"				

Standard Mobile

3 Depths			5 Lengths			2 Heights	
18"	21"	24"	32"	42"	48"	70 ¼"	
			54"	60"		78 ¼"	

Stationary Undercounter

2 Depths		3 Lengths			2 Heights	
14"	18"	24"	36"	48"	27 ¼" Mobile	30" Stationary

High Density Mobile

3 Depths			5 Lengths			2 Heights	
18"	21"	24"	36"	42"	48"	70 ¼"	
			54"	60"		78 ¼"	

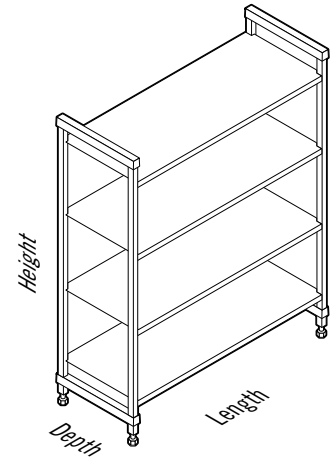

Weight Bearing Capacity

Weight must be evenly distributed across the entire shelf.

		UNIT LENGTH 24" – 60"	UNIT LENGTH 72"
SINGLE UNIT	Unit only	2,400 lbs.	2,400 lbs.
	Shelf only	800	600
	Unit with dunnage stand*	2,800	2,700
	Bottom shelf with dunnage stand*	1,200	900

		UNIT LENGTH 24" – 60"	
CORNER UNIT With 2 Dunnage Stands required	Unit only	2,400	—
	Shelf only	800	—
	Bottom shelf with dunnage stands*	1,200	—

		UNIT LENGTH 24" – 60"	
INTERMEDIATE SHELVES Shelves Installed Between 2 Units	Unit only	2,400	—
	Shelf only	800	—
	Bottom shelf with dunnage stands*	1,200	—
MOBILE UNIT	Unit only**	900	—

*Dunnage Stands add stability and increase weight bearing capacity on bottom shelf only. Highly recommended for Starter Units 54" and longer, all Corner Units, U-Shape Units and units specified for heavier loads. (See Overall Length Quick Reference Guide).

**Due to the weight bearing capacity of casters, maximum weight load on an entire Mobile Unit is 900 lbs. Corner connectors are for use only with shelves 24" - 60" long.

ELEMENTS
XTRA
SERIES

V4

4-SHELF VENTED UNITS

64"
HEIGHT

Starter units include 2 factory assembled stationary post kits, stationary traverses, stationary traverse dovetails and shelf plates. Add-On units include 1 factory assembled stationary post kit, stationary traverses, stationary traverse dovetails and shelf plates. Units ship complete in 1 box.

Starter

Add-On

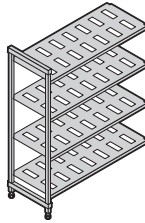
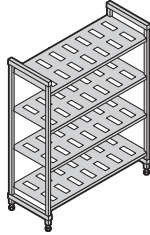

18"
DEPTH

LENGTH	CODE	LIST PRICE EA.
24"	EXU182464V4	\$ 550.00
30"	EXU183064V4	560.00
36"	EXU183664V4	615.00
42"	EXU184264V4	690.00
48"	EXU184864V4	725.00
54"	EXU185464V4	795.00
60"	EXU186064V4	845.00
72"	EXU187264V4	945.00

LENGTH	CODE	LIST PRICE EA.
22"	EXA182464V4	\$ 429.00
28"	EXA183064V4	451.00
34"	EXA183664V4	500.00
40"	EXA184264V4	585.00
46"	EXA184864V4	610.00
52"	EXA185464V4	680.00
58"	EXA186064V4	735.00
70"	EXA187264V4	835.00

21"
DEPTH

24"	EXU212464V4	\$ 595.00
30"	EXU213064V4	610.00
36"	EXU213664V4	670.00
42"	EXU214264V4	760.00
48"	EXU214864V4	790.00
54"	EXU215464V4	880.00
60"	EXU216064V4	940.00
72"	EXU217264V4	1,060.00

22"	EXA212464V4	\$ 472.00
28"	EXA213064V4	489.00
34"	EXA213664V4	560.00
40"	EXA214264V4	645.00
46"	EXA214864V4	675.00
52"	EXA215464V4	765.00
58"	EXA216064V4	820.00
70"	EXA217264V4	940.00

24"
DEPTH

24"	EXU242464V4	\$ 605.00
30"	EXU243064V4	635.00
36"	EXU243664V4	690.00
42"	EXU244264V4	775.00
48"	EXU244864V4	820.00
54"	EXU245464V4	890.00
60"	EXU246064V4	945.00
72"	EXU247264V4	1,070.00

22"	EXA242464V4	\$ 483.00
28"	EXA243064V4	520.00
34"	EXA243664V4	580.00
40"	EXA244264V4	655.00
46"	EXA244864V4	710.00
52"	EXA245464V4	775.00
58"	EXA246064V4	825.00
70"	EXA247264V4	950.00

ELEMENTS
XTRA
SERIES

V4

4-SHELF VENTED UNITS

72"
HEIGHT

Starter units include 2 factory assembled stationary post kits, stationary traverses, stationary traverse dovetails and shelf plates. Add-On units include 1 factory assembled stationary post kit, stationary traverses, stationary traverse dovetails and shelf plates. Units ship complete in 1 box.

Starter

Add-On

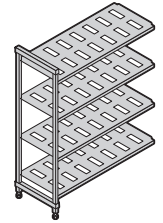
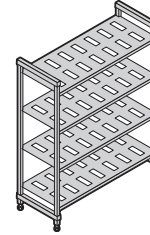

LENGTH	CODE	LIST PRICE EA.
24"	EXU182472V4	\$ 550.00
30"	EXU183072V4	570.00
36"	EXU183672V4	620.00
42"	EXU184272V4	695.00
48"	EXU184872V4	730.00
54"	EXU185472V4	800.00
60"	EXU186072V4	850.00
72"	EXU187272V4	950.00

LENGTH	CODE	LIST PRICE EA.
22"	EXA182472V4	\$ 434.00
28"	EXA183072V4	456.00
34"	EXA183672V4	500.00
40"	EXA184272V4	590.00
46"	EXA184872V4	610.00
52"	EXA185472V4	680.00
58"	EXA186072V4	735.00
70"	EA187272V4	840.00

24"	EXU212472V4	\$ 595.00
30"	EXU213072V4	615.00
36"	EXU213672V4	675.00
42"	EXU214272V4	765.00
48"	EXU214872V4	795.00
54"	EXU215472V4	885.00
60"	EXU216072V4	940.00
72"	EXU217272V4	1,060.00

22"	EXA212472V4	\$ 472.00
28"	EXA213072V4	494.00
34"	EXA213672V4	560.00
40"	EXA214272V4	650.00
46"	EXA214872V4	675.00
52"	EXA215472V4	765.00
58"	EXA216072V4	820.00
70"	EXA217272V4	940.00

24"	EXU242472V4	\$ 610.00
30"	EXU243072V4	645.00
36"	EXU243672V4	695.00
42"	EXU244272V4	775.00
48"	EXU244872V4	825.00
54"	EXU245472V4	900.00
60"	EXU246072V4	950.00
72"	EXU247272V4	1,075.00

22"	EXA242472V4	\$ 483.00
28"	EXA243072V4	525.00
34"	EXA243672V4	585.00
40"	EXA244272V4	655.00
46"	EXA244872V4	710.00
52"	EXA245472V4	780.00
58"	EXA246072V4	825.00
70"	EXA247272V4	955.00

Color: Speckled Gray (480).

V5 5-SHELF VENTED UNITS

84"
HEIGHT

Starter units include 2 factory assembled stationary post kits, stationary traverses, stationary traverse dovetails and shelf plates. Add-On units include 1 factory assembled stationary post kit, stationary traverses, stationary traverse dovetails and shelf plates. Units ship complete in 1 box.

Starter

Add-On

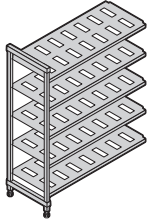
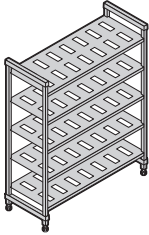

18"
DEPTH

LENGTH	CODE	LIST PRICE EA.
24"	EXU182484V4	\$ 610.00
30"	EXU183084V4	625.00
36"	EXU183684V4	700.00
42"	EXU184284V4	780.00
48"	EXU184884V4	815.00
54"	EXU185484V4	895.00
60"	EXU186084V4	965.00
72"	EXU187284V4	1,080.00

LENGTH	CODE	LIST PRICE EA.
22"	EXA182484V4	\$ 485.00
28"	EXA183084V4	510.00
34"	EXA183684V4	570.00
40"	EXA184284V4	660.00
46"	EXA184884V4	695.00
52"	EXA185484V4	775.00
58"	EXA186084V4	835.00
70"	EXA187284V4	955.00

21"
DEPTH

24"	EXU212484V4	\$ 660.00
30"	EXU213084V4	690.00
36"	EXU213684V4	760.00
42"	EXU214284V4	860.00
48"	EXU214884V4	890.00
54"	EXU215484V4	995.00
60"	EXU216084V4	1,060.00
72"	EXU217284V4	1,195.00

22"	EXA212484V4	\$ 535.00
28"	EXA213084V4	560.00
34"	EXA213684V4	635.00
40"	EXA214284V4	730.00
46"	EXA214884V4	770.00
52"	EXA215484V4	870.00
58"	EXA216084V4	940.00
70"	EXA217284V4	1,065.00

24"
DEPTH

24"	EXU242484V4	\$ 675.00
30"	EXU243084V4	715.00
36"	EXU243684V4	775.00
42"	EXU244284V4	870.00
48"	EXU244884V4	925.00
54"	EXU245484V4	1,005.00
60"	EXU246084V4	1,065.00
72"	EXU247284V4	1,210.00

22"	EXA242484V4	\$ 550.00
28"	EXA243084V4	590.00
34"	EXA243684V4	655.00
40"	EXA244284V4	745.00
46"	EXA244884V4	805.00
52"	EXA245484V4	880.00
58"	EXA246084V4	945.00
70"	EXA247284V4	1,090.00

Color: Speckled Gray (480).

V4 4-SHELF VENTED MOBILE UNITS

Mobile units include 2 factory assembled mobile post kits, mobile traverses, mobile traverse dovetails, shelf plates, and 4 premium swivel casters with total locking brake. Units ship complete in 1 box.

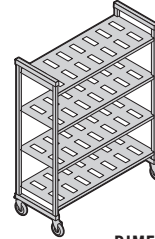

70¼"
HEIGHT

18"
DEPTH

CODE	DIMENSIONS D x L x H*	LIST PRICE EA.
EXMU183670V4	18" x 36" x 70¼"	\$ 890.00
EXMU184270V4	18" x 42" x 70¼"	965.00
EXMU184870V4	18" x 48" x 70¼"	985.00
EXMU185470V4	18" x 54" x 70¼"	1,050.00
EXMU186070V4	18" x 60" x 70¼"	1,105.00

21"
DEPTH

EXMU213670V4	21" x 36" x 70¼"	\$ 945.00
EXMU214270V4	21" x 42" x 70¼"	1,020.00
EXMU214870V4	21" x 48" x 70¼"	1,050.00
EXMU215470V4	21" x 54" x 70¼"	1,130.00
EXMU216070V4	21" x 60" x 70¼"	1,185.00

24"
DEPTH

EXMU243670V4	24" x 36" x 70¼"	\$ 965.00
EXMU244270V4	24" x 42" x 70¼"	1,030.00
EXMU244870V4	24" x 48" x 70¼"	1,080.00
EXMU245470V4	24" x 54" x 70¼"	1,145.00
EXMU246070V4	24" x 60" x 70¼"	1,190.00

78¼"
HEIGHT

18"
DEPTH

CODE	DIMENSIONS D x L x H*	LIST PRICE EA.
EXMU183678V4	18" x 36" x 78¼"	\$ 890.00
EXMU184278V4	18" x 42" x 78¼"	970.00
EXMU184878V4	18" x 48" x 78¼"	990.00
EXMU185478V4	18" x 54" x 78¼"	1,055.00
EXMU186078V4	18" x 60" x 78¼"	1,105.00

21"
DEPTH

EXMU213678V4	21" x 36" x 78¼"	\$ 945.00
EXMU214278V4	21" x 42" x 78¼"	1,025.00
EXMU214878V4	21" x 48" x 78¼"	1,055.00
EXMU215478V4	21" x 54" x 78¼"	1,135.00
EXMU216078V4	21" x 60" x 78¼"	1,190.00

24"
DEPTH

EXMU243678V4	24" x 36" x 78¼"	\$ 965.00
EXMU244278V4	24" x 42" x 78¼"	1,035.00
EXMU244878V4	24" x 48" x 78¼"	1,085.00
EXMU245478V4	24" x 54" x 78¼"	1,145.00
EXMU246078V4	24" x 60" x 78¼"	1,195.00

*Includes 5" casters.

CAMSHELVING ELEMENTS® XTRA SERIES

Corner Connectors

Unique clasp design ensures maximum shelf space utilization without loss of weight bearing in corners and increased weight bearing on middle shelves between units. Use 1 set per shelf to connect starter and add-on units in corners. Connect 4 or 5 intermediate shelves between 2 starter units (2 sets required per shelf).



CODE	DESCRIPTION	LIST PRICE EA.
EXCC1	1 Set for 1 shelf	\$ 13.80
EXCC4	4 Sets for 4 shelves	55.20
EXCC5	5 Sets for 5 shelves	69.00

Color: Speckled Gray (480).

Bottom Shelf Dunnage Stands

Increase weight bearing capacity on bottom shelf only. Add to any shelf length. Highly recommended for starter units 54" and longer and all corner units, intermediate units and units specified for heavier load volume on and off bottom shelves.

Bottom Shelf with Dunnage Stand

UNIT LENGTH	WEIGHT BEARING
Standard Unit	
24"- 48"	1,200 lbs.
54"- 72"	900
Corner Unit with 2 Dunnage Stands	
24"- 60"	1,200

CODE	DIMENSIONS D x H	LIST PRICE EA.
Dunnage Stand – Low (bottom shelf installed on lowest set of open post locations for dovetails)		
CSDS14H6	14" x 6½"	\$ 69.00
CSDS18H6	18" x 6½"	71.25
CSDS21H6	21" x 6½"	73.00
CSDS24H6	24" x 6½"	74.75

Dunnage Stand – Tall (bottom shelf installed up on 2nd set of open post locations for dovetails)		
CSDS14H10	14" x 10½"	\$ 75.25
CSDS18H10	18" x 10½"	77.50
CSDS21H10	21" x 10½"	79.25
CSDS24H10	24" x 10½"	81.00

Case Pack: 1 Color: Speckled Gray (480).

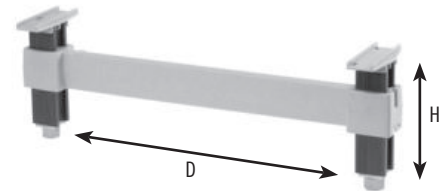

Shelf Traverses

Available in single or double packs. Use two traverses to add an open shelf for divider bars or drying cradles. Add one stationary traverse onto back posts of a stationary unit for extra support when placing rolling equipment under the first shelf. Traverse dovetails included.

LENGTH	SINGLE PACK CODE*	LIST PRICE EA.	DOUBLE PACK CODE**	LIST PRICE EA.
24"	EXTR24	\$ 36.90	EXTR242PK	\$ 70.50
30"	EXTR30	39.95	EXTR302PK	76.25
36"	EXTR36	41.55	EXTR362PK	79.25
42"	EXTR42	44.35	EXTR422PK	84.50
48"	EXTR48	48.35	EXTR482PK	92.25
54"	EXTR54	52.50	EXTR542PK	100.00
60"	EXTR60	56.50	EXTR602PK	108.00
72"	EXTR72	64.75	—	—

*Case Pack: 1 **Case Pack: 2
Color: Speckled Gray (480).



Elements XTRA Shelf Traverses covered by U.S. Patent D 989,612 S, 11,812,847 B2, 11,697,037 B2.

V4 4-Shelf Vented High Density Mobile Units

70¹/₄"
HEIGHT

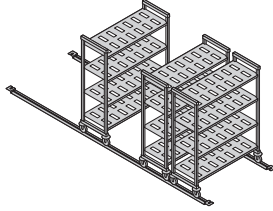

Units include 2 factory assembled mobile post kits,
8 traverses, shelf plates, 4 high density casters and
4 high density donut bumpers. Units ship complete in 1 box.

18"
DEPTH

CODE	DIMENSIONS D x L x H	LIST PRICE EA.
EXHD183670V4	18" x 36" x 70 ¹ / ₄ "	\$ 964.00
EXHD184270V4	18" x 42" x 70 ¹ / ₄ "	1,034.00
EXHD184870V4	18" x 48" x 70 ¹ / ₄ "	1,056.00
EXHD185470V4	18" x 54" x 70 ¹ / ₄ "	1,136.00
EXHD186070V4	18" x 60" x 70 ¹ / ₄ "	1,187.00

21"
DEPTH

EXHD213670V4	21" x 36" x 70 ¹ / ₄ "	1,024.00
EXHD214270V4	21" x 42" x 70 ¹ / ₄ "	1,114.00
EXHD214870V4	21" x 48" x 70 ¹ / ₄ "	1,144.00
EXHD215470V4	21" x 54" x 70 ¹ / ₄ "	1,232.00
EXHD216070V4	21" x 60" x 70 ¹ / ₄ "	1,292.00

24"
DEPTH

EXHD243670V4	24" x 36" x 70 ¹ / ₄ "	1,051.00
EXHD244270V4	24" x 42" x 70 ¹ / ₄ "	1,124.00
EXHD244870V4	24" x 48" x 70 ¹ / ₄ "	1,179.00
EXHD245470V4	24" x 54" x 70 ¹ / ₄ "	1,249.00
EXHD246070V4	24" x 60" x 70 ¹ / ₄ "	1,304.00

78¹/₄"
HEIGHT

18"
DEPTH

CODE	DIMENSIONS D x L x H	LIST PRICE EA.
EXHD183678V4	18" x 36" x 78 ¹ / ₄ "	\$ 978.00
EXHD184278V4	18" x 42" x 78 ¹ / ₄ "	1,048.00
EXHD184878V4	18" x 48" x 78 ¹ / ₄ "	1,101.00
EXHD185478V4	18" x 54" x 78 ¹ / ₄ "	1,180.00
EXHD186078V4	18" x 60" x 78 ¹ / ₄ "	1,237.00

21"
DEPTH

EXHD213678V4	21" x 36" x 78 ¹ / ₄ "	1,035.00
EXHD214278V4	21" x 42" x 78 ¹ / ₄ "	1,125.00
EXHD214878V4	21" x 48" x 78 ¹ / ₄ "	1,155.00
EXHD215478V4	21" x 54" x 78 ¹ / ₄ "	1,243.00
EXHD216078V4	21" x 60" x 78 ¹ / ₄ "	1,303.00

24"
DEPTH

EXHD243678V4	24" x 36" x 78 ¹ / ₄ "	1,062.00
EXHD244278V4	24" x 42" x 78 ¹ / ₄ "	1,135.00
EXHD244878V4	24" x 48" x 78 ¹ / ₄ "	1,190.00
EXHD245478V4	24" x 54" x 78 ¹ / ₄ "	1,260.00
EXHD246078V4	24" x 60" x 78 ¹ / ₄ "	1,135.00

Color: Speckled Gray (480).

S4 4-Shelf Solid High Density Mobile Units

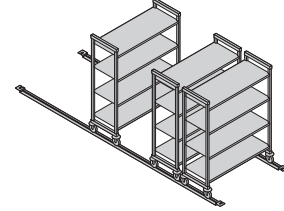

CODE	DIMENSIONS D x L x H	LIST PRICE EA.
EXHD183670S4	18" x 36" x 70 ¹ / ₄ "	\$ 980.00
EXHD184270S4	18" x 42" x 70 ¹ / ₄ "	1,056.00
EXHD184870S4	18" x 48" x 70 ¹ / ₄ "	1,087.00
EXHD185470S4	18" x 54" x 70 ¹ / ₄ "	1,166.00
EXHD186070S4	18" x 60" x 70 ¹ / ₄ "	1,223.00

EXHD213670S4	21" x 36" x 70 ¹ / ₄ "	1,051.00
EXHD214270S4	21" x 42" x 70 ¹ / ₄ "	1,139.00
EXHD214870S4	21" x 48" x 70 ¹ / ₄ "	1,184.00
EXHD215470S4	21" x 54" x 70 ¹ / ₄ "	1,264.00
EXHD216070S4	21" x 60" x 70 ¹ / ₄ "	1,328.00

EXHD243670S4	24" x 36" x 70 ¹ / ₄ "	1,078.00
EXHD244270S4	24" x 42" x 70 ¹ / ₄ "	1,159.00
EXHD244870S4	24" x 48" x 70 ¹ / ₄ "	1,209.00
EXHD245470S4	24" x 54" x 70 ¹ / ₄ "	1,293.00
EXHD246070S4	24" x 60" x 70 ¹ / ₄ "	1,349.00

CODE	DIMENSIONS D x L x H	LIST PRICE EA.
EXHD183678S4	18" x 36" x 78 ¹ / ₄ "	\$ 994.00
EXHD184278S4	18" x 42" x 78 ¹ / ₄ "	1,070.00
EXHD184878S4	18" x 48" x 78 ¹ / ₄ "	1,070.00
EXHD185478S4	18" x 54" x 78 ¹ / ₄ "	1,150.00
EXHD186078S4	18" x 60" x 78 ¹ / ₄ "	1,201.00

EXHD213678S4	21" x 36" x 78 ¹ / ₄ "	1,062.00
EXHD214278S4	21" x 42" x 78 ¹ / ₄ "	1,150.00
EXHD214878S4	21" x 48" x 78 ¹ / ₄ "	1,195.00
EXHD215478S4	21" x 54" x 78 ¹ / ₄ "	1,275.00
EXHD216078S4	21" x 60" x 78 ¹ / ₄ "	1,339.00

EXHD243678S4	24" x 36" x 78 ¹ / ₄ "	1,089.00
EXHD244278S4	24" x 42" x 78 ¹ / ₄ "	1,170.00
EXHD244878S4	24" x 48" x 78 ¹ / ₄ "	1,220.00
EXHD245478S4	24" x 54" x 78 ¹ / ₄ "	1,304.00
EXHD246078S4	24" x 60" x 78 ¹ / ₄ "	1,360.00

High Density Full Track and Track Extension Kits

Each kit ships complete in 1 box with aluminum raised track rails and stainless steel hardware required to complete installation.

CODE	DESCRIPTION	CASE PACK	LIST PRICE EA.
Full Track Kits			
CSMHDTK10	10' Track for 3 Mobile Units*	1	\$ 835.00
CSMHDTK12	12' Track for 4 Mobile Units*	1	965.00
CSMHDTK145	14.5' Track for 5 Mobile Units*	1	1,080.00

Color: Silver (000). *Based on 24" deep mobile units.

Full Track Kits include: Track rails, rail joiners, end plates, 8 stainless steel leveling feet (for stationary units) and required hardware.

CODE	DESCRIPTION	CASE PACK	LIST PRICE EA.
Track Extension Kits			
CSMHDTKE4	4.5' Track Extension	1	\$ 314.00
CSMHDTKE5	5' Track Extension	1	336.00
CSMHDTKE6	6' Track Extension	1	402.00

Color: Silver (000). **Extension Track Kits include:** Track rails (1 set), 2 rail joiners, and required hardware.



Track rail (underside) shown with end plate installed.



Track rail (underside) shown with track rail joiner partially installed.

It is highly recommended to install a stationary starter unit every 15' of track to further stabilize the system.



High Density Caster With Donut Bumper



CODE	SIZE	LIST PRICE EA.
EXMCHD	5"	TBD
Case Pack: 2 Color: Gray (000).		



CAMSHELVING

BASICS® PLUS

series

STATIONARY

- Posts and traverses made of a revolutionary, extremely strong, composite material with a smooth, easy to clean surface.
- Attach left and right traverse dovetails to each post to secure shelf traverses every 4".
- Removable polypropylene shelf plates with permanent, molded-in Camguard®, an antimicrobial technology that inhibits the growth of mold, fungus, and bacteria.
- Sturdy reinforced threaded nylon foot adjusts easily to level units.
- Withstands storage temperatures from -36°F to 190°F.
- Lifetime warranty against rust and corrosion.



camguard
ANTIMICROBIAL SHELF PLATES



COMPONENT



Post Connectors, Corner Connectors, Floor Fastener, Wall Fastener, Shelf Rails, Single Shelf Security Cage, Shelf Divider Panels and Identification Tags are not NSF listed.

CAMSHELVING BASICS® PLUS SERIES

STARTER UNITS

Ship complete in 1 box. Includes factory assembled post frames for quicker assembly.

Stationary

3 Depths			6 Lengths			3 Heights		
18"	21"	24"	30"	36"	42"	64"	72"	84"
			48"	54"	60"			

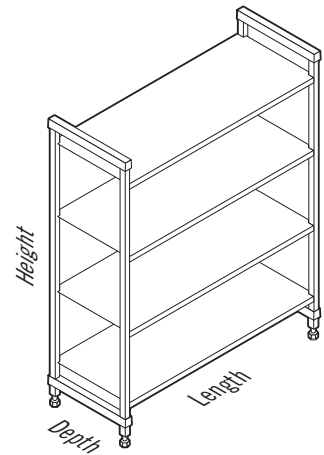

Weight Bearing Capacity

Weight must be evenly distributed across the entire shelf.

		UNIT LENGTH	UNIT LENGTH
		30" - 48"	54" - 60"
SINGLE UNIT	Unit only	1,800 lbs. (TÜV)***	1,800 lbs. (TÜV)***
	Shelf only	700 (TÜV)	500 (TÜV)
	Unit with dunnage stand*	2,100	2,100
	Bottom shelf with dunnage stand*	1,000	800
CORNER UNIT** With 2 Dunnage Stands required	Unit only	1,350	—
	Shelf only	300	—
	Bottom shelf with dunnage stands*	450	—

*Dunnage Stands add stability and increase weight bearing capacity on bottom shelf only. Highly recommended for Starter Units 54" and longer, all Corner Units, U-Shape Units and units specified for heavier loads. (See Overall Length Quick Reference Guide).

**Corner connectors are for use only with shelves 30" - 48" long.

***TÜV Certification applies to Single Unit and Single Shelf only.





BASICS PLUS SERIES

64"

HEIGHT

V4 4-SHELF VENTED UNITS

Starter units include 2 factory assembled post kits and shelves. Add-on units include 1 factory assembled post kit and shelves. Units ship complete in 1 box.

Starter

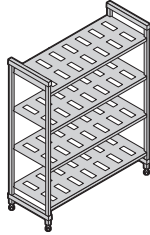

Add-On

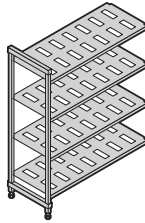

18"
DEPTH

DIMENSIONS D x L x H	CODE	LIST PRICE EA.	CODE	LIST PRICE EA.
18" x 30" x 64"	CBU183064V4	\$ 451.00	CBA183064V4	\$ 359.00
18" x 36" x 64"	CBU183664V4	489.00	CBA183664V4	407.00
18" x 42" x 64"	CBU184264V4	555.00	CBA184264V4	467.00
18" x 48" x 64"	CBU184864V4	585.00	CBA184864V4	483.00
18" x 54" x 64"	CBU185464V4	635.00	CBA185464V4	550.00
18" x 60" x 64"	CBU186064V4	675.00	CBA186064V4	590.00

21"
DEPTH

21" x 30" x 64"	CBU213064V4	\$ 483.00	CBA213064V4	\$ 397.00
21" x 36" x 64"	CBU213664V4	540.00	CBA213664V4	451.00
21" x 42" x 64"	CBU214264V4	610.00	CBA214264V4	520.00
21" x 48" x 64"	CBU214864V4	635.00	CBA214864V4	540.00
21" x 54" x 64"	CBU215464V4	710.00	CBA215464V4	610.00
21" x 60" x 64"	CBU216064V4	755.00	CBA216064V4	660.00

24"
DEPTH

24" x 30" x 64"	CBU243064V4	\$ 510.00	CBA243064V4	\$ 418.00
24" x 36" x 64"	CBU243664V4	555.00	CBA243664V4	462.00
24" x 42" x 64"	CBU244264V4	615.00	CBA244264V4	525.00
24" x 48" x 64"	CBU244864V4	655.00	CBA244864V4	560.00
24" x 54" x 64"	CBU245464V4	720.00	CBA245464V4	620.00
24" x 60" x 64"	CBU246064V4	755.00	CBA246064V4	660.00

Color: Brushed Graphite (580).

BASICS PLUS SERIES

72"

HEIGHT

V4 4-SHELF VENTED UNITS

Starter units include 2 factory assembled post kits and shelves. Add-on units include 1 factory assembled post kit and shelves. Units ship complete in 1 box.

Starter

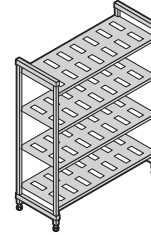

Add-On

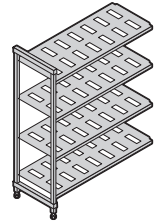

DIMENSIONS D x L x H	CODE	LIST PRICE EA.	CODE	LIST PRICE EA.
18" x 30" x 72"	CBU183072V4	\$ 456.00	CBA183072V4	\$ 359.00
18" x 36" x 72"	CBU183672V4	494.00	CBA183672V4	407.00
18" x 42" x 72"	CBU184272V4	560.00	CBA184272V4	467.00
18" x 48" x 72"	CBU184872V4	585.00	CBA184872V4	483.00
18" x 54" x 72"	CBU185472V4	645.00	CBA185472V4	550.00
18" x 60" x 72"	CBU186072V4	680.00	CBA186072V4	595.00

21" x 30" x 72"	CBU213072V4	\$ 489.00	CBA213072V4	\$ 402.00
21" x 36" x 72"	CBU213672V4	540.00	CBA213672V4	451.00
21" x 42" x 72"	CBU214272V4	610.00	CBA214272V4	520.00
21" x 48" x 72"	CBU214872V4	645.00	CBA214872V4	540.00
21" x 54" x 72"	CBU215472V4	715.00	CBA215472V4	610.00
21" x 60" x 72"	CBU216072V4	755.00	CBA216072V4	660.00

24" x 30" x 72"	CBU243072V4	\$ 510.00	CBA243072V4	\$ 418.00
24" x 36" x 72"	CBU243672V4	560.00	CBA243672V4	462.00
24" x 42" x 72"	CBU244272V4	620.00	CBA244272V4	525.00
24" x 48" x 72"	CBU244872V4	660.00	CBA244872V4	570.00
24" x 54" x 72"	CBU245472V4	720.00	CBA245472V4	620.00
24" x 60" x 72"	CBU246072V4	760.00	CBA246072V4	665.00



BASICS PLUS SERIES
84"
HEIGHT

V5
5-SHELF VENTED UNITS

Starter units include 2 factory assembled post kits and shelves. Add on units include 1 factory assembled post kit and shelves. Units ship complete in 1 box.

Starter

Add-On

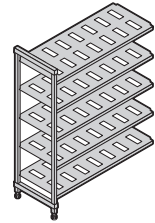
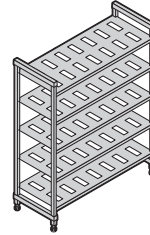

18"
DEPTH

DIMENSIONS
D x L x H

18" x 30" x 84"
18" x 36" x 84"
18" x 42" x 84"
18" x 48" x 84"
18" x 54" x 84"
18" x 60" x 84"

CODE

CBU183084V5
CBU183684V5
CBU184284V5
CBU184884V5
CBU185484V5
CBU186084V5

LIST PRICE EA.

\$ 550.00
605.00
680.00
715.00
785.00
835.00

CODE

CBA183084V5
CBA183684V5
CBA184284V5
CBA184884V5
CBA185484V5
CBA186084V5

LIST PRICE EA.

\$ 440.00
494.00
580.00
605.00
675.00
730.00

21"
DEPTH

21" x 30" x 84"
21" x 36" x 84"
21" x 42" x 84"
21" x 48" x 84"
21" x 54" x 84"
21" x 60" x 84"

CBU213084V5
CBU213684V5
CBU214284V5
CBU214884V5
CBU215484V5
CBU216084V5

\$ 600.00
660.00
750.00
780.00
870.00
920.00

CBA213084V5
CBA213684V5
CBA214284V5
CBA214884V5
CBA215484V5
CBA216084V5

\$ 483.00
555.00
635.00
670.00
760.00
815.00

24"
DEPTH

24" x 30" x 84"
24" x 36" x 84"
24" x 42" x 84"
24" x 48" x 84"
24" x 54" x 84"
24" x 60" x 84"

CBU243084V5
CBU243684V5
CBU244284V5
CBU244884V5
CBU245484V5
CBU246084V5

\$ 620.00
675.00
755.00
800.00
880.00
935.00

CBA243084V5
CBA243684V5
CBA244284V5
CBA244884V5
CBA245484V5
CBA246084V5

\$ 510.00
570.00
650.00
695.00
765.00
820.00

Color: Brushed Graphite (580).

CAMSHELVING BASICS® PLUS SERIES

Corner Connectors

Unique patented design ensures maximum shelf space utilization. Use 1 set per shelf to connect starter and add-on units in corners. Connect 4 or 5 intermediate shelves between 2 starter units (2 sets required per shelf). Available as a single set or 8 or 10 set packs.

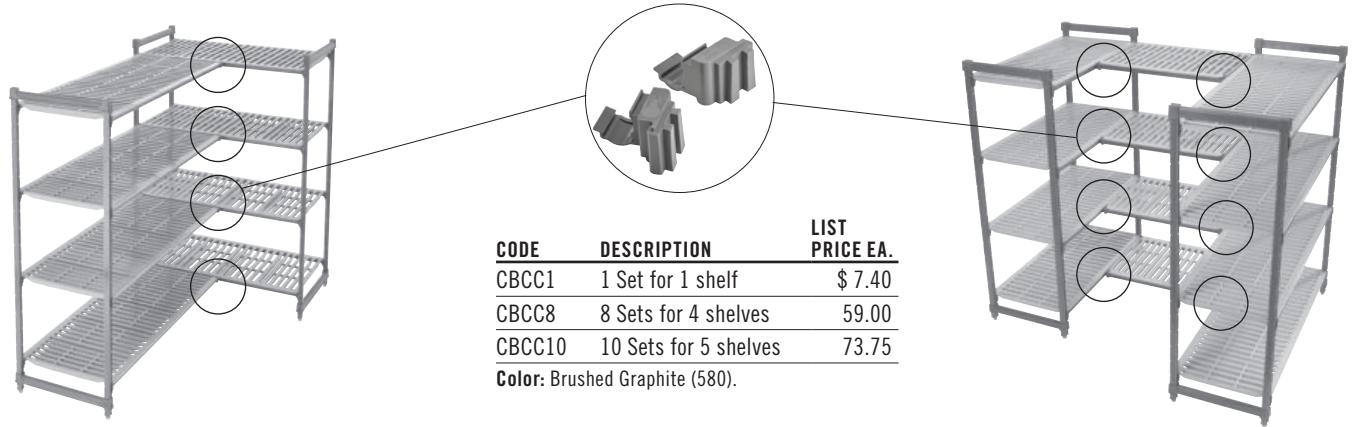

CODE	DESCRIPTION	LIST PRICE EA.
CBCC1	1 Set for 1 shelf	\$ 7.40
CBCC8	8 Sets for 4 shelves	59.00
CBCC10	10 Sets for 5 shelves	73.75

Color: Brushed Graphite (580).

Bottom Shelf Dunnage Stands

Increase weight bearing capacity on bottom shelf only. Add to any shelf length. Highly recommended for starter units 54" and longer and all corner units, intermediate units and units specified for heavier load volume on and off bottom shelves.

CODE	DIMENSIONS D x H	LIST PRICE EA.
Dunnage Stand – Low		
CBDS18H6	18" x 6¾"	\$ 67.50
CBDS21H6	21" x 6¾"	69.50
CBDS24H6	24" x 6¾"	71.00
Dunnage Stand – Tall		
CBDS18H10	18" x 10¾"	68.00
CBDS21H10	21" x 10¾"	69.75
CBDS24H10	24" x 10¾"	71.25

Case Pack: 1 Color: Brushed Graphite (580).

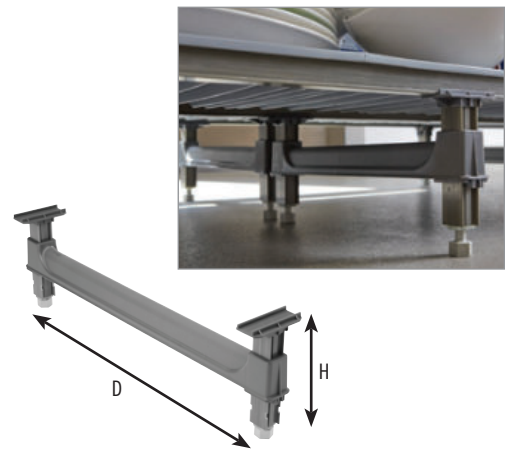

Shelf Traverses

Add one traverse onto back posts for extra support when placing rolling equipment under the first shelf. Traverse dovetails included.

LENGTH	SINGLE PACK CODE*	LIST PRICE EA.	DOUBLE PACK CODE**	LIST PRICE EA.
30"	CBTR30	\$ 36.25	CBTR302PK	\$ 66.00
36"	CBTR36	36.55	CBTR362PK	66.50
42"	CBTR42	40.55	CBTR422PK	73.50
48"	CBTR48	44.35	CBTR482PK	80.75
54"	CBTR54	48.35	CBTR542PK	87.75
60"	CBTR60	52.25	CBTR602PK	94.75

*Case Pack: 1 **Case Pack: 2 Color: Brushed Graphite (580).





CAMSHELVING® ACCESSORIES

Identification Tags

Clip onto shelf traverses to clearly identify stored product. Made of highly durable plastic with a clear slide in front panel. 14 labels included: 12 color-coded, pre-printed and 2 blank.

CODE	DESCRIPTION	DIMENSION L x H	LIST PRICE EA.
Premium and Elements XTRA Series			
CSID6	6" ID Tag	6" x 1"	\$ 3.00
CSID3	3" ID Tag	3" x 1"	3.00
Basics Plus Series			
CBID6	6" ID Tag	6" x 1"	3.75

Case Pack: 12 **Color:** White / Clear.
Pre-printed, color labels, 2 each: Blue - Cooked Foods, Beige - Fish, Yellow - Poultry, White - Dairy, Green - Fruits and Vegetables, Red - Raw Meat.



Wall Fastener

Use to secure stationary shelving unit to a wall for added safety and stability where required. Made of stainless steel. Screws not included.

CODE	DIMENSION D x L x H	LIST PRICE EA.
CSWF	2 7/8" x 9 3/8" x 1 1/8"	\$ 43.15

Case Pack: 4 **Color:** Silver (000).



Hole diameter 7/16".



Floor Fasteners

Secure stationary unit posts directly to the floor for added safety and stability where required. Made of stainless steel. Bolts not included.

CODE	DIMENSION D x L x H*	LIST PRICE EA.
Premium, Elements XTRA & Basics Plus Series		
CSFF	1 1/2" x 6 1/2" x 3 1/2"	\$ 44.35
Premium Series High Density		
CSHDF	1 3/8" x 4 1/4" x 1/2"	\$ 54.00

CSFF Case Pack: 2
CSHDF Case Pack: 4
Color: Silver (000).



Hole diameter 9/16".
 *Height of CSFF includes height of stainless-steel leveling foot.

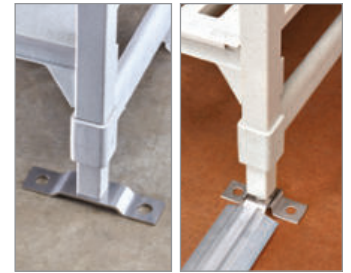

Donut Bumper

Offers added protection during transport and when maneuvering mobile units into place against walls or alongside other units for storage.

CODE	DIAMETER	LIST PRICE EA.
Premium Series		
CPMDB	3 1/2"	\$ 12.55
Premium Series High Density		
CSMHDB	5"	31.05
Elements XTRA Series		
CSMHDB	5"	31.05

Case Pack: 4 **Color:** Gray (000).

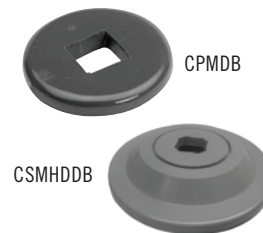

Shelf Divider Panel

Stack and separate items stored on shelves. Made of highly durable plastic. Installs directly onto solid or vented shelves. Easily removable for relocating or washing. Use with Shelf Rails to prevent contents from falling off shelves.

CODE	DIMENSION D x H	LIST PRICE EA.
CSSD188	18" x 8"	\$ 22.85
CSSD218	21" x 8"	24.85
CSSD248	24" x 8"	26.90

Case Pack: 1 **Color:** Soft Gray (151).



CAMSHELVING® ACCESSORIES

Shelf Divider Bars (for 24" deep shelf only)

Create a custom service or storage station for food pans, boxes or dish racks. Install straight or angled dividers directly onto shelf traverses.

CODE	DESCRIPTION	LIST PRICE EA.
Premium Series		
CSDBA	Angled Divider Bar	\$ 7.50
CSDBS	Straight Divider Bar	7.50
Elements XTRA Series		
EDBA	Angled Divider Bar	6.00
EDBS	Straight Divider Bar	6.00
Case Pack: 4 Color: Speckled Gray (480).		



Shelf Rails

Use to prevent contents from falling off shelves. Protect individual sides or ends or wrap a full shelf. Rods are made from a strong composite material that is highly durable and will never rust or corrode.

Fits shelving units 24" to 72" wide and 14" to 24" deep.

Full or three-quarter shelf kits help to streamline installations and significantly reduces carton waste.

Shelf Rail kits are available in all depths and all lengths. To see the entire selection of Full & 3/4 kits, see the Camshelving Product Specification and Price List.

Full Shelf Rail Kits

PREMIUM CODE	ELEMENTS XTRA CODE	BASICS PLUS CODE	DIMENSION D x L	LIST PRICE EA.
Full Shelf Rail Kits (2 sides, 2 ends)				
CPR2436	ESR2436	CBR2436	24" x 36"	\$ 163.00
CPR2442	ESR2442	CBR2442	24" x 42"	175.00
CPR2448	ESR2448	CBR2448	24" x 48"	182.00
3/4 Shelf Rail Kits (1 side, 2 ends)				
CPR24363	ESR24363	CBR24363	24" x 36"	117.25
CPR24423	ESR24423	CBR24423	24" x 42"	121.75
CPR24483	ESR24483	CBR24483	24" x 48"	127.00

Case Pack: 1 Color: Soft Gray (151).

Single Side Rail Kits

PREMIUM CODE	ELEMENTS XTRA CODE	BASICS PLUS CODE	DIMENSION LENGTH	LIST PRICE EA.
CPR24S	ESR24S	—	24"	\$ 38.60
CPR30S	ESR30S	CBR30S	30"	42.40
CPR36S	ESR36S	CBR36S	36"	46.40
CPR42S	ESR42S	CBR42S	42"	51.75
CPR48S	ESR48S	CBR48S	48"	55.75
CPR54S	ESR54S	CBR54S	54"	61.00
CPR60S	ESR60S	CBR60S	60"	65.00
CPR72S	ESR72S	—	72"	74.00

Case Pack: 1 Color: Soft Gray (151).

Single End Rail Kits

PREMIUM CODE	ELEMENTS XTRA CODE	BASICS PLUS CODE	DIMENSION DEPTH	LIST PRICE EA.
CPR14E	ESR14E	—	14"	\$ 29.20
CPR18E	ESR18E	CBR18E	18"	31.55
CPR21E	ESR21E	CBR21E	21"	33.35
CPR24E	ESR24E	CBR24E	24"	35.25

Case Pack: 1 Color: Soft Gray (151).



CAMSHELVING® ACCESSORIES

Ultimate Sheet Pan Rack for Single Shelf

The lightweight, durable Ultimate Sheet Pan Rack for Single Shelf will transform your storage capabilities. Designed to fit securely on a 24" deep Camshelving unit, this single shelf rack holds 6 full size (1826) or 12 half size (1318) sheet pans in a compact space. Use to stage and hold prepped ingredients, defrost product in the cooler or quickly cool baked goods. Designed to accept pans directly out of a 350°F oven. Ships knockdown.

CODE	DIMENSION D x L x H	LIST PRICE EA.
Premium or Elements XTRA Series		
CSUPR1826S6	24 $\frac{1}{8}$ " x 20 $\frac{1}{2}$ " x 20 $\frac{1}{4}$ "	\$ 236.00
Basics Plus Series		
CBUPR1826S6	24 $\frac{1}{8}$ " x 20 $\frac{1}{2}$ " x 20 $\frac{1}{4}$ "	236.00
Case Pack: 1 Color: Brushed Graphite (580). Patent applied for.		



Single Shelf Security Cage (for 24" deep shelf only)

Securely store valuable products on a single shelf. Made of heavy duty, 304 stainless steel for use in any environment. Requires 18" height between shelves. Install on vented shelves only. Lock not included.

CODE	DIMENSION D x L x H	LIST PRICE EA.
CSSC244818	25 $\frac{1}{4}$ " x 42 $\frac{1}{2}$ " x 18"	\$ 1,110.00
Case Pack: 1 Color: Silver (000).		



Premium Series Full-Wrap Security Cage for D 24" x L 48" shelf and H 64" stationary or H 67" mobile

Store valuable products behind locked doors. Made of heavy-duty 304 stainless steel for use in any environment. Stationary or mobile units ship complete with factory assembled post kits, 2 vented shelves, 4 premium swivel casters with total locking brake for mobile unit and 1 full wrap security cage. Can be used with Divider Panels. Assembly requires bottom vented shelf. Additional shelves can be ordered separately. Cage and Units ship knockdown. Lock not included.



CODE	CPFWSC244860	CPU244864SUPKG	CPMU244867SUPKG
DESCRIPTION	Full-wrap Security Cage only	Full-wrap Stationary Security Unit	Full-wrap Mobile Security Unit
DIMENSION D x L x H	26 $\frac{3}{4}$ " x 50 $\frac{1}{4}$ " x 61 $\frac{1}{2}$ "	26 $\frac{3}{4}$ " x 50 $\frac{1}{4}$ " x 64 $\frac{1}{2}$ "	26 $\frac{3}{4}$ " x 50 $\frac{1}{4}$ " x 67 $\frac{3}{4}$ "
COLOR	Silver (000)	Speckled Gray (480)	Speckled Gray (480)
LIST PRICE EA.	\$ 4,180.00	\$ 4,650.00	\$ 5,255.00

Case Pack: 1 Cage only ships in 1 box. Units ship in 2 boxes.

UTILITY SHELVING

Vertical Drying and Storage Rack

Promotes sanitary drying, safe handling and efficient storage for trays, sheet pans, cutting boards and lids. Can be used with Shelf Rails to prevent contents from sliding off.

Units ship complete with factory assembled mobile post kits, 6 traverses, 12 or 15 vertical drying cradles and premium swivel casters with total locking brake. Assembly required.



Modular 7-slot rack can be ordered separately to customize a drying and storage rack. Made of highly durable ABS plastic. Slots are spaced 1 $\frac{1}{16}$ " wide and dividers are 2 $\frac{1}{2}$ " high.



CODE	DIMENSIONS D x L x H	HOLDING CAPACITY	CASE PACK	LIST PRICE EA.
Premium Series Vertical Drying and Storage Rack				
CPMU244875DRPKG	24" x 48" x 75"	84 Trays	1	\$ 1,895.00
CPMU246075DRPKG	24" x 60" x 75"	105 Trays	1	2,130.00
Vertical Drying and Storage Cradle for 24" deep shelf only (Fits all Camshelving® lines)				
CSDR7	23 $\frac{1}{2}$ " x 10 $\frac{1}{4}$ " x 3 $\frac{3}{4}$ "	—	1	75.25
CSDR73	23 $\frac{1}{2}$ " x 10 $\frac{1}{4}$ " x 3 $\frac{3}{4}$ "	—	3	226.00

Drying Rack Color: Speckled Gray (480). **Drying Cradle Color:** Soft Gray (151).
48" long unit ships in 5 boxes. 60" long unit ships in 6 boxes.

Angled Drying and Storage Rack

Promotes sanitary drying, safe handling and efficient product organization with easy access to product.

Unit ships complete with factory assembled mobile post kits, 8 traverses, 16 angled drying cradles and premium swivel casters with total locking brake. Assembly required.



Uniquely designed cradle holds up to 8 each meal delivery pellets or use to dry, store and transport food pans and other commercial kitchen ware. Installs directly onto shelf traverses. Made of highly durable ABS plastic. Slots are spaced 2 $\frac{3}{8}$ " apart.



CODE	DIMENSIONS D x L x H	HOLDING CAPACITY	CASE PACK	LIST PRICE EA.
Premium Series Angled Drying and Storage Rack				
CPMU244875PDPKG	24" x 48" x 75"	128 Pellets and Bases or 16 GN 1/1 Food Pans	1	\$ 2,220.00
Angled Drying and Storage Cradle for 24" deep shelf only (Fits all Camshelving® lines)				
CSDR8	23 $\frac{5}{16}$ " x 10 $\frac{1}{8}$ " x 6 $\frac{5}{16}$ "	—	1	60.50
CSDR84	23 $\frac{5}{16}$ " x 10 $\frac{1}{8}$ " x 6 $\frac{5}{16}$ "	—	4	242.00

Drying Rack Color: Speckled Gray (480). CPMU244875PDPKG Ships in 5 boxes.
Drying Cradle Color: Soft Gray (151).

UTILITY SHELVING

Dome Drying and Storage Rack

Promotes sanitary drying, safe handling and efficient product organization with easy access to product.

Unit ships complete with factory assembled mobile post kits, 10 traverses, 10 dome drying cradles and premium swivel casters with total locking brake. Assembly required.

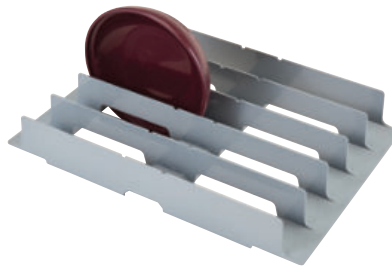

Use to dry and safely store up to 10 patient meal delivery domes or plate covers upright. Installs directly onto shelf traverses. Made of highly durable ABS plastic. Slots are spaced 3/16" apart.



CODE	DIMENSIONS D x L x H	HOLDING CAPACITY	CASE PACK	LIST PRICE EA.
Premium Series Dome Drying and Storage Rack				
CPMU243675DDPKG	24" x 36" x 75"	100 Domes	1	\$ 1,950.00
Dome Drying and Storage Cradle for 24" deep shelf only (Fits all Camshelving® lines)				
CSDDC24	24" x 16½" x 3⅜"	—	1	87.50
CSDDC245	24" x 16½" x 3⅜"	—	5	434.00

Drying Rack Color: Speckled Gray (480). CPMU243675DDPKG Ships in 3 boxes.
Drying Cradle Color: Soft Gray (151).

Elements® XTRA Series 2-Shelf Vented Undercounter Units

Create storage in underutilized or hard-to-reach undercounter areas. Ideal for storing condiments, to-go containers, and paper disposables. Stationary units include 2 factory assembled stationary post kits, 4 stationary traverses, stationary traverse dovetails and shelf plates.

Mobile units include 2 factory assembled mobile post kits, 4 mobile traverses, mobile traverse dovetails, shelf plates, and 4 premium swivel casters with total locking brake.



CODE	DIMENSIONS D x L x H*	LIST PRICE EA.
Stationary Units		
EXU183630V2	18" x 36" x 30"	\$ 397.00
EXU184830V2	18" x 48" x 30"	440.00
Mobile Units		
EXMU142427V2	14" x 24" x 27¼"	670.00
EXMU143627V2	14" x 36" x 27¼"	755.00
EXMU144827V2	14" x 48" x 27¼"	800.00

Color: Brushed Graphite (580). Ships in 1 box. *Height includes casters.

Camshelving® Wine Rack

Full Wine Rack Units & Kits

- > Unit holds up to 144 bottles.
- > Add kits to customize existing shelving.
- > Holds standard size wine bottles.
- > Available in 14" or 18" depth.

Easy to Clean
Ultra Hygienic
Highly Durable



COMPONENTS
(WINE CRADLES &
CONNECTORS NOT
INCLUDED)

UTILITY SHELVING — CAMSHELVING® WINE RACK UNITS & KITS



Four Cradle Shelf Kits, Single Stack

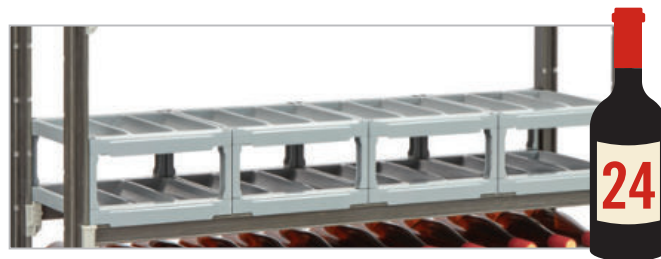

Eight Cradle Shelf Kits, Double Stack



Twelve Cradle Shelf Kits, Triple Stack



Single Cradle Add On Kits

Camshelving® Wine Rack Units

CODE	DESCRIPTION	DIMENSIONS	HOLDING CAPACITY	LIST PRICE EA.
CPUWR144872	Premium Series Stationary Wine Rack Unit	14" x 48" x 72"	144 Standard Bottles of Wine (750 ml)	\$ 2,175.00
EXUWR144872	Elements XTRA Stationary Wine Rack Unit	14" x 48" x 72"	144 Standard Bottles of Wine (750 ml)	1,860.00

Color: Speckled Gray (480). Each UNIT includes: 2 Factory Assembled Post Frames, 8 Traverses, 48 each Wine Cradles, 32 Bags of Cradle Connectors.

Camshelving® Wine Cradle Kits

CODE	DESCRIPTION	DIMENSIONS D x W x H*	HOLDING CAPACITY	LIST PRICE EA.
Single Cradle Add On Kits (Single Cradle with Bag of Connectors)				
CSWRKIT14P1	Wine Cradle Kit 14" Deep 1PK	13.28" x 11.16" x 1.5"	3 Bottles	\$ 44.25
CSWRKIT18P1	Wine Cradle Kit 18" Deep 1PK	17.28" x 11.16" x 1.5"	3 Bottles	50.45
Four Cradle Shelf Kits, Single Stack (Four Cradles, No Connectors)				
CSWRC14P4	Wine Cradles Only 14" Deep 4 EA	13.28" x 44.64" x 1.5"	12 Bottles	120.00
CSWRC18P4	Wine Cradles Only 18" Deep 4 EA	17.28" x 44.64" x 1.5"	12 Bottles	145.00
Eight Cradle Shelf Kits, Double Stack (Eight Cradles with 4 Bags of Connectors)				
CSWRKIT14P8	Wine Cradle Kit 14" Deep 8PK	13.28" x 44.64" x 6.3"	24 Bottles	250.00
CSWRKIT18P8	Wine Cradle Kit 18" Deep 8PK	17.28" x 44.64" x 6.3"	24 Bottles	295.00
Twelve Cradle Shelf Kits, Triple Stack (Twelve Cradles with 8 Bags of Connectors)				
CSWRKIT14P12	Wine Cradle Kit 14" Deep 12PK	13.28" x 44.64" x 11.26"	36 Bottles	375.00
CSWRKIT18P12	Wine Cradle Kit 18" Deep 12PK	17.28" x 44.64" x 11.26"	36 Bottles	440.00

Color: Soft Gray (151). *Overall length is based on 4 cradles installed side by side along 48" traverses.

Cradle Kits fit all Camshelving lines — Premium Series, Elements XTRA Series, and Basics Plus Series.

Optional Accessories

CODE	DESCRIPTION	DIMENSIONS D x L x H	LIST PRICE EA.
CSFF	Floor Fastener	1.5" x 6.5" x 3.75"	\$44.35
CSWF	Wall Fastener	2.9" x 3.4" x 1.9"	43.15
CSDS14H6	Dunnage Stand	14" x 6.5"	69.00
CSID6	Identification Tag	6" x 1"	3.00
CSID3	Identification Tag	3" x 1"	3.00

Colors: Floor and Wall Fastener Stainless Steel (000), Dunnage Stand Speckled Gray (480), Identification Tags White/Clear (000).

CAMSHELVING®

PEGBOARD STORAGE SYSTEM

STRONG

Heavy-duty, commercial grade plastic

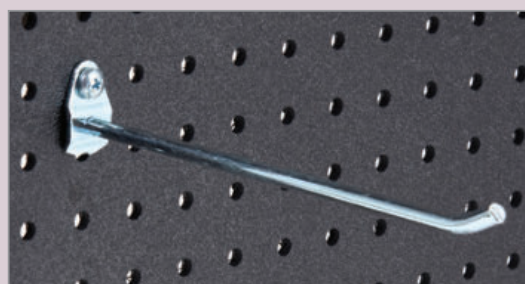

Unique double locking, 6" straight stainless steel pegboard hook features bottom locking tab and top stainless steel screw.

CSPEGKIT18
W 18" x H 48"
LIST PRICE EACH: \$ 370.00

CSPEGKIT21
W 21" x H 48"
LIST PRICE EACH: \$ 420.00

CSPEGKIT24
W 24" x H 48"
LIST PRICE EACH: \$ 470.00

CSPEGKITW
Wall Mount Kit
LIST PRICE EACH: \$ 45.75

CSPEGH6
6" Peg Hooks (12 each)
LIST PRICE EACH: \$ 57.20

CAMSHELVING®



UNIVERSAL STORAGE RACK



A Unique Way to
**MAXIMIZE
SPACE**

Modular components,
rail panels + brackets = customizable storage.
Access top, middle or bottom items individually.

HOLDS EVERYTHING
food pans, boxes, sheet pans, trays, and
even pizza dough boxes



VERTICAL STORAGE
between shelves
eliminates unused space

CREATE "DRAWER" STORAGE



Premium® / Elements XTRA® Series

Basics® Plus Series

21"
DEPTH

CSUNVR21
LIST PRICE EACH: \$ 155.00
CSUNVRA21
LIST PRICE EACH: \$ 85.00

CBUNVR21
LIST PRICE EACH: \$ 155.00
CBUNVRA21
LIST PRICE EACH: \$ 85.00

24"
DEPTH

CSUNVR24
LIST PRICE EACH: \$ 165.00
CSUNVRA24
LIST PRICE EACH: \$ 90.00

CBUNVR24
LIST PRICE EACH: \$ 165.00
CBUNVRA24
LIST PRICE EACH: \$ 90.00

UTILITY SHELVING — CAMSHELVING® ULTIMATE #10 CAN RACK SYSTEM

Create the can storage system your operation needs with the Ultimate #10 Can Rack. This first ever plastic can rack makes storing and inventorying #10 and #5 cans so much easier.

- Front-loading, gravity-fed system supports FIFO organization and food rotation with no need to move the rack for loading or unloading.
- Made with easy to clean, smooth surfaces. Can be completely disassembled and run through the dishwasher.
- Lifetime warranty against rust and corrosion. Made from durable, reinforced plastic material.
- Single, Add-on Can Racks and Full-Size Can Rack Units each ship complete in 1 box. Units include pre-assembled post kits.

Color: Brushed Graphite (580).

Ultimate #10 Can Rack is covered by U.S. Patents D828,145 S and D827,421 S.

NSF Component on shelving only.



Premium® Series



Elements® XTRA Series



Full Size Stationary Can Rack Unit

This free-standing can rack holds up to 96 cans in a compact space. Install on the end of a Camshelving High Density unit for maximum space utilization. Ships knockdown in 1 box with 2 factory-assembled post kits.

Full Size Stationary Add-on Can Rack Unit

Maximize every inch of linear space in your kitchen or dry storage area with an in-line can rack. With just 1 factory assembled post kit, connect a can rack to standard shelving units in a straight line by sharing posts.



Storage Capacity

	#10 Can	#5 Can
SINGLE OR ADD-ON CAN RACK	8 each	12 each
FULL-SIZE CAN RACK UNIT (26" x 36" x 72", 3 tiers)	96	144

Holds #10 and #5 cans 6.7" to 7.07" tall.



UTILITY SHELVING — CAMSHELVING® ULTIMATE #10 CAN RACK SYSTEM



CODE	CPU243672C96*	EXU243672C96*	CPA243672C96**	EXA243672C96**
DESCRIPTION	Premium Series Full-Size Stationary Can Rack Unit (Free Standing)	Elements XTRA Series Full-Size Stationary Can Rack Unit (Free Standing)	Premium Series Full-Size Add-On Can Rack Unit (Shared Post)	Elements XTRA Series Full-Size Add-On Can Rack Unit (Shared Post)
DIMENSION D x L x H	26" x 36" x 72"	26" x 36" x 72"	26" x 34¼" x 72"	26" x 34" x 72"
LIST PRICE EACH	\$ 1,275.00	\$ 1,130.00	\$ 1,080.00	\$ 990.00

Case Pack: 1 Ships in 1 box. **Premium Series Color:** Speckled Gray (480). **Elements XTRA Series Color:** Brushed Graphite (580).
 *Unit includes: 2 pre-assembled post kits, 9 traverses, 15 panels and 72 brackets. **Unit includes: 1 pre-assembled post kit, 9 traverses, 15 panels and 72 brackets.

Single and Add-on Can Racks

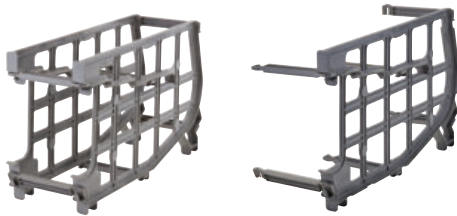

CODE	UCR10R8	UCR10AR8
DESCRIPTION	Single Can Rack, 2 panels and 6 brackets	Add-on Can Rack, 1 panel and 6 brackets
DIMENSION D x L x H	26" x 9¼" x 15½"	26" x 7¼" x 15½"
LIST PRICE EACH	\$ 144.50	\$ 84.75

Case Pack: 1 Color: Brushed Graphite (580).



Can Racks Per Length

SHELF LENGTH	NUMBER OF CAN RACKS PER TIER*	LEFTOVER SHELF SPACE	#10 CAN HOLDING CAPACITY
24"	2	3.5"	16
30"	3	2"	24
36"	4	0"	32
42"	4	6.5"	32
48"	5	5"	40
54"	6	3.5"	48
60"	7	2"	56

*1 Single Rack plus Add-on Racks.

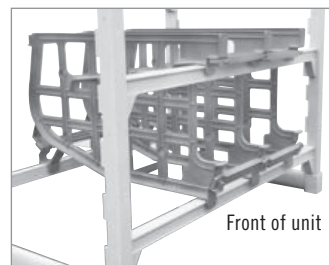

Front of unit

NOTE: Each tier of can racks requires 3 traverses, 2 front and 1 rear. Leave two open dovetails above top traverse before installing the next traverse/tier. This allows space to load cans.

CAMSHELVING® ULTIMATE SHEET PAN RACK

Designed for durability.
Buy once. Use forever.

Molded-in Rails =
No Broken Welds



Low maintenance,
Easy to clean.

Quiet, smooth glide,
swivel casters.
All with brake.



CAMSHELVING® ULTIMATE SHEET PAN RACK



Full Size

Half Size

Undercounter

CODE	DIMENSIONS L x W x H*	RAIL SPACING	HOLDING CAPACITY	CASTER TYPE**	LIST PRICE EA.
Full Size Knockdown (KD) Units					
UPR1826FP20	33 ³ / ₈ " x 25 ⁷ / ₁₆ " x 72 ³ / ₈ "	3"	20 Sheet pans/trays	Plastic	\$ 1,000.00
UPR1826FP40	33 ³ / ₈ " x 25 ⁷ / ₁₆ " x 72 ³ / ₈ "	1 ¹ / ₂ "	40 Sheet pans/trays	Plastic	1,015.00
Full Size Factory Assembled (FA) Units					
UPR1826FPA20	33 ³ / ₈ " x 25 ⁷ / ₁₆ " x 72 ³ / ₈ "	3"	20 Sheet pans/trays	Plastic	1,300.00
UPR1826FPA40	33 ³ / ₈ " x 25 ⁷ / ₁₆ " x 72 ³ / ₈ "	1 ¹ / ₂ "	40 Sheet pans/trays	Plastic	1,380.00

Color: Brushed Graphite (580). *Dimensions include 5" plastic casters.
Weight capacity: 350 lbs. per rack, 55 lbs. per rail set.

Half Size Knockdown (KD) Units					
UPR1826HP12	33 ³ / ₈ " x 25 ⁷ / ₁₆ " x 48"	3"	12 Sheet pans/trays	Plastic	735.00
UPR1826HP20	33 ³ / ₈ " x 25 ⁷ / ₁₆ " x 41 ⁵ / ₈ "	1 ¹ / ₂ "	20 Sheet pans/trays	Plastic	800.00

Color: Brushed Graphite (580). *Dimensions include 5" plastic casters. **Weight capacity:** 175 lbs. per rack, 55 lbs. per rail set.

Undercounter Knockdown (KD) Units					
UPR1826U8	30 ⁷ / ₈ " x 23 ³ / ₄ " x 33 ³ / ₈ "	3"	8 Sheet pans/trays	Metal	650.00
UPR1826U15	30 ⁷ / ₈ " x 23 ³ / ₄ " x 31 ¹ / ₂ "	1 ¹ / ₂ "	15 Sheet pans/trays	Metal	710.00

Color: Brushed Graphite (580). *Dimensions include 3" metal casters. **Weight capacity:** 90 lbs. per rack, 55 lbs. per rail set.

CAMSHELVING® GN FOOD PAN TROLLEYS

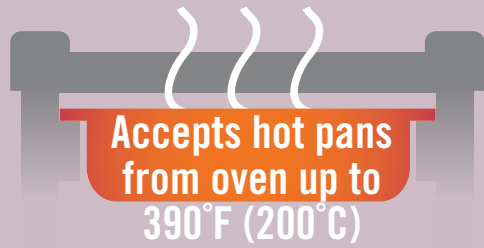

Hold **MORE** Food Pans in **LESS** Space

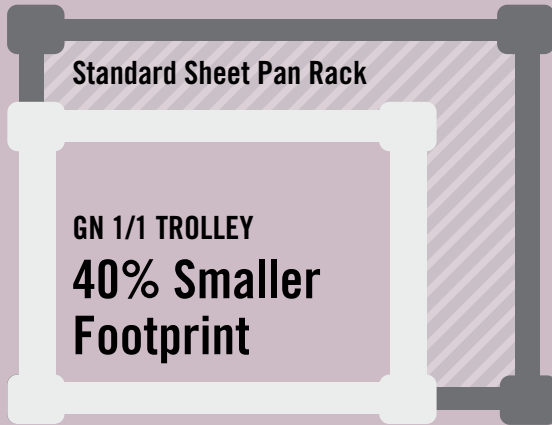

Highly Durable

Low Maintenance

Quiet, smooth glide, swivel
casters. All with brake.



Use in Kitchen, Freezer or Cooler



EASY TO
Assemble

GN 1/1 Trolleys

1 full-size pan
per rail set, end load



UGNPR11H9
D 28¾" x L 17¼" x H 40"
LIST PRICE EACH: \$ 735.00
inStock item

UGNPR11F18
D 28¾" x L 17¼" x H 67½"
LIST PRICE EACH: \$ 980.00
inStock item

2½" x9
4" x4

2½" x18
4" x9

GN 2/1 Trolleys

2 full-size pans
per rail set, side load



UGNPR21H18
D 32⅞" x L 25⅜" x H 40"
LIST PRICE EACH: \$ 755.00

UGNPR21F36
D 32⅞" x L 25⅜" x H 67½"
LIST PRICE EACH: \$ 1,040.00

2½" x18
4" x8

2½" x36
4" x18



Unique top frame holds a full size food pan or cutting board. Use to protect contents below or create a light duty work space.

PAN STOPS

Lock and secure pans on rails, especially during transport.

For Food Pan Trolleys

UGNPRPSF (Full Size)

LIST PRICE EACH: \$ 114.00

UGNPRPSH (Half Size)

LIST PRICE EACH: \$ 103.25

For Sheet Pan Racks

UPRPSF (Full Size)

LIST PRICE EACH: \$ 114.00

UPRPSH (Half Size)

LIST PRICE EACH: \$ 103.25



FULL SIZE COVERS

Protect contents held/staged in kitchens, coolers, or freezers.

For Food Pan Trolleys

GBCTUGNPR11 (Vinyl)

L 26" x W 18 5/8" x H 60 7/8"

LIST PRICE EACH: \$ 179.00

GBCTUGNPR21 (Vinyl)

L 31" x W 26 3/4" x H 60 7/8"

LIST PRICE EACH: \$ 202.00

For Sheet Pan Racks

GBCTUPR (Vinyl)

L 32" x W 24" x H 66"

LIST PRICE EACH: \$ 204.00

inStock item

GBIRC272162 (Insulated)

L 27 1/2" x W 21 1/2" x H 62"

LIST PRICE EACH: \$ 700.00



CA PROP 65



Camshelving® Elevation Series Wall Shelving

Elevate your wall storage with a new vertical storage system that will never rust, corrode, peel or dent. Choose from standard Sink or Work Station Kits or customize your space with individual components, and a wide variety of Type 304 stainless steel accessories.



Unmatched Durability

**Easy To Clean
Ultra Hygienic**

Prep Station Kit



Sink Station Kit



Task Station Kit



**Kits Ship All
In 1 Box**



STANDARD STATION KITS

- Everything ships in 1 box for basic storage needs.
- Dimensions for all kits (D x W x H installed as shown):
18" x 36" (shelf length only) x 30¼". Overall length with Wall Track is 40".

Starter Kits Include:

1 40" Wall Track, 2 Wall Uprights, 1 Vented Shelf Kit, 1 Hanging Pegboard, Accessories*

CODE	DESCRIPTION	LIST PRICE EA.
EWS36SINK	SINK KIT	\$ 1020.00
EWS36PREP	PREP KIT	1,145.00
EWS36TASK	TASK KIT	625.00

Case Pack: 1 each Color: Black (110).
Wall mounting hardware not included.

Add-on Kits Include:

1 40" Wall Track, 1 Wall Uprights, 1 Vented Shelf Kit, 1 Hanging Pegboard, Accessories*

CODE	DESCRIPTION	LIST PRICE EA.
EWSA36SINK	SINK KIT 1	\$ 940.00
EWSA36PREP	PREP KIT 2	1,065.00
EWSA36TASK	TASK KIT	545.00

Case Pack: 1 each Color: Black (110).
Wall mounting hardware not included.

*Task Stations Do Not Include Accessories. Accessories Must Be Purchased Separately.



Sink Station Starter Kit



Task Station Add-on Kit

INDIVIDUAL COMPONENTS

Wall Tracks

- Heavy duty, non-corrosive 6063 aluminum.
- Pre-drilled drain holes 16" on center.
- Wall mounting holes 8" on center.

CODE	DIMENSIONS L x D x H	LIST PRICE EA.
EWST40	40" x 13½" x 1½"	\$ 30.00
EWST56	56" x 13½" x 1½"	45.00

Case Pack: 1 each Color: Aluminum (000).

Vertical Wall Uprights

- Extremely durable, reinforced nylon.
- Sturdy molded in upright hooks.
- Wall mounting holes 7½" on center.

DIMENSIONS W x D x H	STORAGE HOOKS	SINGLE PACK CODE	LIST PRICE EA.	DOUBLE PACK CODE	LIST PRICE EA.
1¾" x 2¼" x 15"	5	EWSU15	\$ 38.00	EWSU152PK	\$ 62.00
1¾" x 2¼" x 30"	11	EWSU30	65.00	EWSU302PK	107.00
1¾" x 2¼" x 45"	17	EWSU45	79.00	EWSU452PK	130.00

Color: Black (110).
Wall mounting hardware not included.

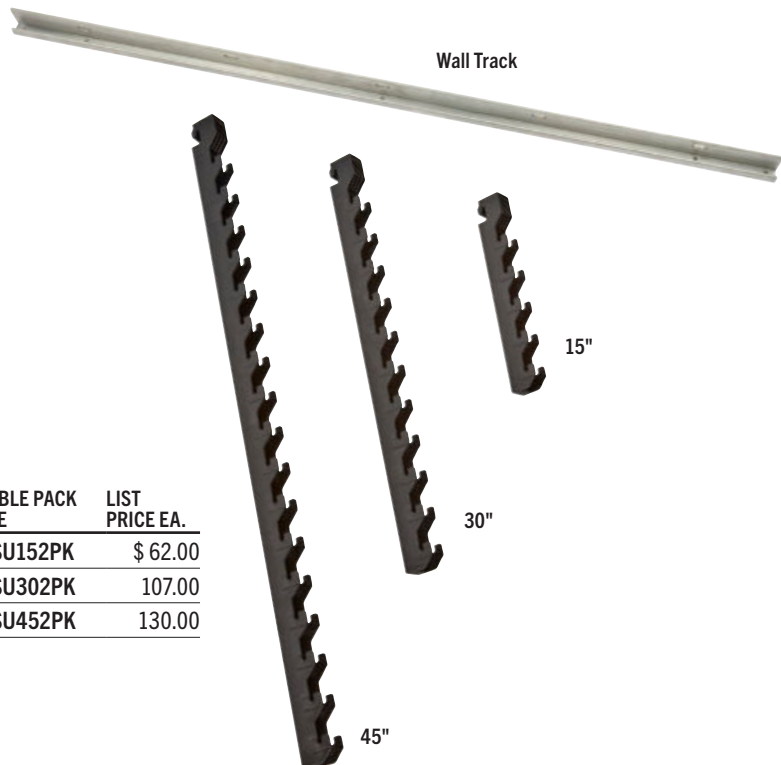

Wall Track

15"

30"

45"

SHELF KITS

- Extra strong composite and plastic shelf frame with 2 or 1 Universal Shelf Brackets.
- Each Universal Shelf Bracket must be installed on 3 hooks per wall upright. Overall shelf height: 8 7/8".
- Polypropylene shelf plates with molded-in antimicrobial CamGuard® protection.

Solid



Vented



14" DEPTH

LENGTH	STARTER CODE	LIST PRICE EA.	ADD-ON CODE	LIST PRICE EA.
24"	EWSSK1424S	\$ 227.00	EWSSKA1424S	\$ 191.00
30"	EWSSK1430S	242.00	EWSSKA1430S	205.00
36"	EWSSK1436S	253.00	EWSSKA1436S	215.00
42"	EWSSK1442S	263.00	EWSSKA1442S	227.00
48"	EWSSK1448S	275.00	EWSSKA1448S	238.00

STARTER CODE	LIST PRICE EA.	ADD-ON CODE	LIST PRICE EA.
EWSSK1424V	\$ 224.00	EWSSKA1424V	\$ 187.00
EWSSK1430V	238.00	EWSSKA1430V	201.00
EWSSK1436V	248.00	EWSSKA1436V	211.00
EWSSK1442V	257.00	EWSSKA1442V	221.00
EWSSK1448V	267.00	EWSSKA1448V	231.00

18" DEPTH

LENGTH	STARTER CODE	LIST PRICE EA.	ADD-ON CODE	LIST PRICE EA.
24"	EWSSK1824S	\$ 255.00	EWSSKA1824S	\$ 212.00
30"	EWSSK1830S	269.00	EWSSKA1830S	226.00
36"	EWSSK1836S	284.00	EWSSKA1836S	241.00
42"	EWSSK1842S	303.00	EWSSKA1842S	260.00
48"	EWSSK1848S	316.00	EWSSKA1848S	273.00

STARTER CODE	LIST PRICE EA.	ADD-ON CODE	LIST PRICE EA.
EWSSK1824V	\$ 243.00	EWSSKA1824V	\$ 200.00
EWSSK1830V	255.00	EWSSKA1830V	213.00
EWSSK1836V	265.00	EWSSKA1836V	223.00
EWSSK1842V	288.00	EWSSKA1842V	235.00
EWSSK1848V	299.00	EWSSKA1848V	250.00

21" DEPTH

LENGTH	STARTER CODE	LIST PRICE EA.	ADD-ON CODE	LIST PRICE EA.
24"	EWSSK2124S	\$ 276.00	EWSSKA2124S	\$ 226.00
30"	EWSSK2130S	293.00	EWSSKA2130S	242.00
36"	EWSSK2136S	304.00	EWSSKA2136S	260.00
42"	EWSSK2142S	321.00	EWSSKA2142S	285.00
48"	EWSSK2148S	337.00	EWSSKA2148S	302.00

STARTER CODE	LIST PRICE EA.	ADD-ON CODE	LIST PRICE EA.
EWSSK2124V	\$ 263.00	EWSSKA2124V	\$ 216.00
EWSSK2130V	277.00	EWSSKA2130V	232.00
EWSSK2136V	287.00	EWSSKA2136V	242.00
EWSSK2142V	306.00	EWSSKA2142V	271.00
EWSSK2148V	324.00	EWSSKA2148V	289.00

24" DEPTH

LENGTH	STARTER CODE	LIST PRICE EA.	ADD-ON CODE	LIST PRICE EA.
24"	EWSSK2424S	\$ 294.00	EWSSKA2424S	\$ 246.00
30"	EWSSK2430S	312.00	EWSSKA2430S	264.00
36"	EWSSK2436S	328.00	EWSSKA2436S	284.00
42"	EWSSK2442S	357.00	EWSSKA2442S	309.00
48"	EWSSK2448S	379.00	EWSSKA2448S	331.00

STARTER CODE	LIST PRICE EA.	ADD-ON CODE	LIST PRICE EA.
EWSSK2424V	\$ 284.00	EWSSKA2424V	\$ 236.00
EWSSK2430V	299.00	EWSSKA2430V	251.00
EWSSK2436V	309.00	EWSSKA2436V	261.00
EWSSK2442V	339.00	EWSSKA2442V	282.00
EWSSK2448V	351.00	EWSSKA2448V	303.00

Case Pack: 1 each Color: Brushed Graphite (580).

Case Pack: 1 each Color: Brushed Graphite (580).

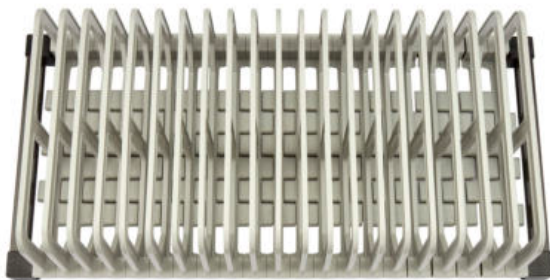

18" DEPTH



Individual Drying Rack Divider

DRYING RACK SHELF KITS

- Open shelf frame with polypropylene drying rack dividers.
- 1 1/4" slot spacing for sheet pans, trays and cutting boards.
- Ships knockdown. Easy to install.

DIMENSIONS D x L x H	DRYING SLOTS	STARTER CODE	LIST PRICE EA.	ADD-ON CODE	LIST PRICE EA.
18" x 36" x 14 1/2"	20	EWSDRY1836	\$ 496.00	EWSDRYA1836	\$ 478.00
18" x 48" x 14 1/2"	28	EWSDRY1848	549.00	EWSDRYA1848	531.00

Case Pack: 1 each Color: Speckled Gray (480).

Kits Include: 1 Open Shelf Frame, 1 or 2 Straight Universal Shelf Brackets, 21 (36" length) or 29 (48" length) Drying Rack Dividers.

OPEN SHELF FRAMES AND UNIVERSAL SHELF BRACKETS

- Combine with shelf brackets and accessories to create custom storage sections or stations.
- Install with Straight or Angled Universal Shelf Brackets.
- Add Divider Bars with Food Pans, Drying Cradles or Wine Cradles.

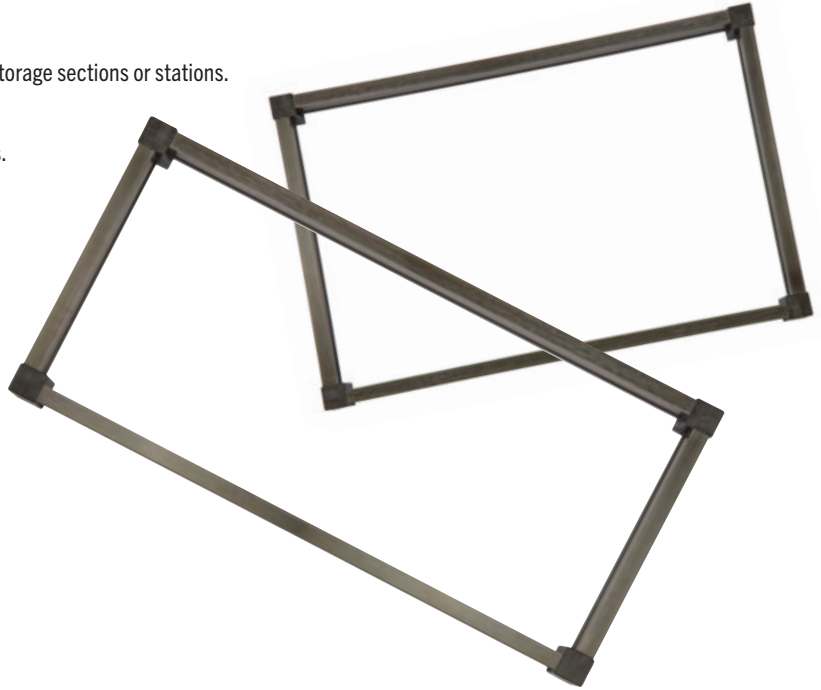

Open Shelf Frames

CODE	DEPTH	LENGTH	LIST PRICE EA.
EWSOPEN1436	14"	36"	\$ 121.00
EWSOPEN1448	14"	48"	138.00
EWSOPEN1836	18"	36"	148.00
EWSOPEN1848	18"	48"	168.00
EWSOPEN2136	21"	36"	158.00
EWSOPEN2148	21"	48"	178.00
EWSOPEN2436	24"	36"	170.00
EWSOPEN2448	24"	48"	188.00

Case Pack: 1 each Color: Brushed Graphite (580).

Universal Shelf Brackets

SHELF DEPTH	STRAIGHT CODE	LIST PRICE EA.	ANGLED CODE	LIST PRICE EA.
14"	EWSSBS14	\$ 50.00	EWSSBA14	\$ 50.00
18"	EWSSBS18	54.00	EWSSBA18	54.00
21"	EWSSBS21	58.00	EWSSBA21	58.00
24"	EWSSBS24	62.00	EWSSBA24	62.00

Case Pack: 1 each Color: Black (110).



Straight



Angled

OPEN SHELF FRAME ACCESSORIES

Straight Shelf Divider Bars

- Use to hang a variety of food pans.
- Can also be used to hang drying cradles vertically.

CODE	FRAME DEPTH	LIST PRICE EA.
CBDBS14	14"	\$ 6.70
CBDBS18	18"	10.00
CBDBS21	21"	10.20
CBDBS24	24"	10.70

Case Pack: 4 each Color: Speckled Gray (480).



OPEN SHELF FRAME ACCESSORIES

Wine Cradle Kits

- Fits 48" long open shelf frame only.
- Single stack kits only are recommended.

CODE	FRAME DEPTH	LIST PRICE EA.
CSWRC14P4	14"	\$ 120.00
CSWRC18R4	18"	145.00

Case Pack: 4 each Color: Soft Gray (151).

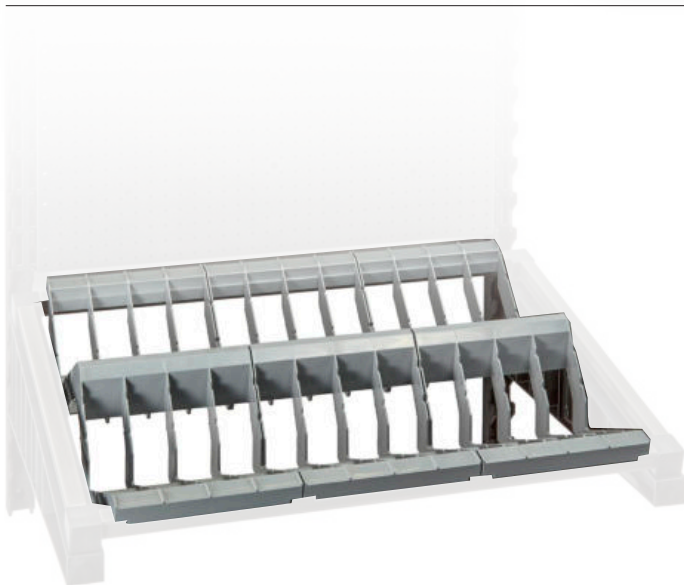

Drying & Storage Racks

- Use to dry and store miscellaneous prep or storage items.
- Fits 24" deep shelf frames only.

CODE	DESCRIPTION	36" FRAME LENGTH	48" FRAME LENGTH	LIST PRICE EA.
CSDR8	MULTI PURPOSE	3 Each	4 Each	\$ 60.50
CSDDC24	DOME/PLATE COVER	3 Each	N/A	87.50

Case Pack: 1 each Color: Soft Gray (151).

PEGBOARDS

- 1/4" thick ABS plastic with molded in peg holes.
- Attach securely onto wall upright hooks or mount directly onto the wall between wall uprights.
- Maximum weight bearing per pegboard is 100 lbs.

Hanging Pegboard

Hanging Pegboard can be installed to hang lower than bottom of uprights. At least 4 slot sets (7 sets per side) must be fully engaged on wall upright hooks.

CODE	SIZE H x L	LIST PRICE EA.
EWSFPB36	18" x 36"	\$ 235.00

Case Pack: 1 each Color: Black (110).

Wall Mount Pegboard

CODE	LENGTH	HEIGHT	LIST PRICE EA.
EWSFP1824	24"	18"	\$ 135.00
EWSFP1830	30"	18"	150.00
EWSFP1836	36"	18"	200.00
EWSFP1842	42"	18"	210.00
EWSFP1848	48"	18"	225.00
EWSFP2430	30"	24"	205.00
EWSFP2436	36"	24"	225.00
EWSFP2448	48"	24"	285.00
EWSFP3036	36"	30"	270.00
EWSFP3048	48"	30"	350.00

Case Pack: 1 each Color: Black (110).
Wall mounting hardware included.

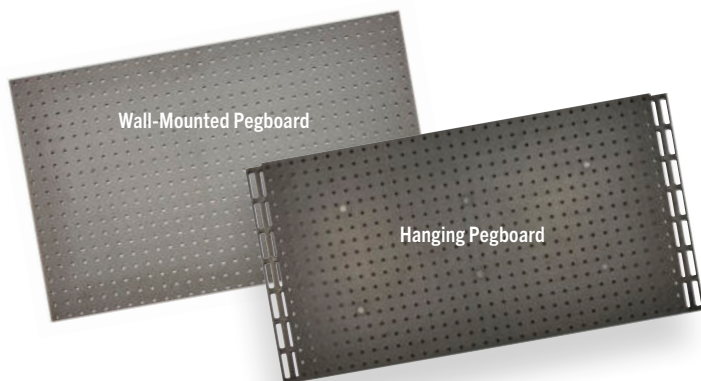

PEGBOARD ACCESSORIES

- Type 304 Stainless Steel.
- Each accessory includes screws.
- Unique double locking tab design.
- Superior stability and performance.
- Maximum weight bearing per peg hook is 15 lbs.

CODE	DESCRIPTION	OVERALL DIMENSIONS L/W x D x H	LIST PRICE EA.
EWSACC1	8-BOTTLE HOLDER	12 ³ / ₄ " x 5" x 8"	\$ 65.00
EWSACC2	LARGE UTENSIL HOLDER	11 ³ / ₄ " x 10 ¹ / ₄ " x 3 ³ / ₄ "	70.00
EWSACC3	SMALL UTENSIL HOLDER	11 ³ / ₄ " x 4 ³ / ₄ " x 3 ³ / ₄ "	50.00
EWSACC4	CYLINDER WITH HOLDER	4 ¹ / ₂ " x 6 ¹ / ₂ " x 6 ¹ / ₂ "	80.00
EWSACC5	BIN WITH HOLDER	5" x 12 ¹ / ₈ " x 4 ¹ / ₄ "	40.00
EWSACC6	LARGE WIRE BASKET	17 ³ / ₈ " x 7 ³ / ₄ " x 6 ¹ / ₂ "	110.00
EWSACC7	1/3 SIZE DRAIN PAN W/ HOLDER*	12 ³ / ₄ " x 7" x 5 ³ / ₄ "	50.00
EWSACC8	6" STRAIGHT PEGS, 8 EACH	3/4" x 6 ¹ / ₂ " x 1 ³ / ₈ "	85.00
EWSACC9	SMALL WIRE SHELF/LID HOLDER	14 ³ / ₄ " x 8 ¹ / ₈ " x 3"	50.00

Case Pack: 1 each Color: Stainless Steel (000).
 Pegboard screws included. *This is a Cambro Polypropylene Colander Pan, 1/3 Size, 35CLRPP190
 Recommended Tool: Phillips Head #2 Screwdriver.

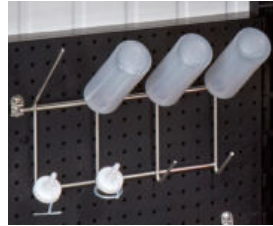
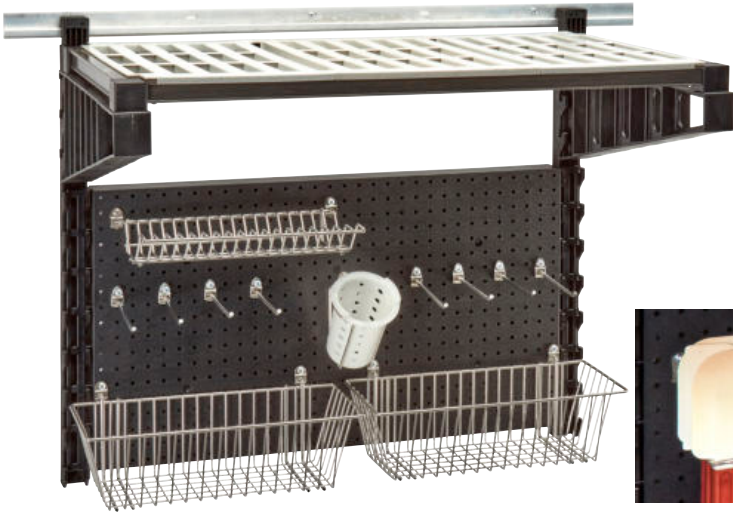

EWSACC1
8-BOTTLE HOLDER



EWSACC2
LARGE UTENSIL HOLDER

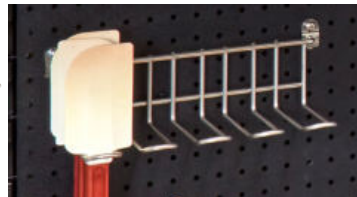

EWSACC3
SMALL UTENSIL HOLDER



EWSACC4
CYLINDER
& HOLDER



EWSACC5
LARGE BIN & HOLDER

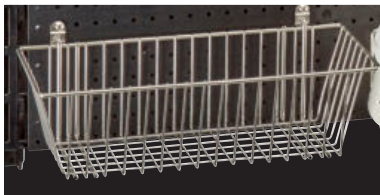

EWSACC6
LARGE WIRE BASKET



EWSACC7
DRAIN PAN & HOLDER



EWSACC8
STRAIGHT 6" PEGS

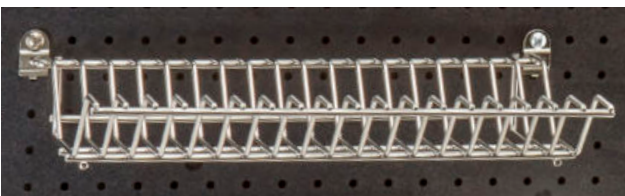

EWSACC9
SMALL SHELF/LID HOLDER

OTHER ACCESSORIES

- Use to prevent contents from falling off shelves.
- Rods are made of extra strong composite material.
- Plastic brackets snap tightly and securely onto frames.

Full Shelf Rail Kits (2 ends, 1 front)

14" DEPTH	CODE	LENGTH	LIST PRICE EA.
	EWSR1424	24"	\$ 97.00
EWSR1430	30"	109.00	
EWSR1436	36"	113.00	
EWSR1442	42"	117.00	
EWSR1448	48"	121.00	

18" DEPTH	CODE	LENGTH	LIST PRICE EA.
	EWSR1824	24"	\$ 99.00
EWSR1830	30"	111.00	
EWSR1836	36"	116.00	
EWSR1842	42"	120.00	
EWSR1848	48"	123.00	

21" DEPTH	CODE	LENGTH	LIST PRICE EA.
	EWSR2124	24"	\$ 101.00
EWSR2130	30"	113.00	
EWSR2136	36"	118.00	
EWSR2142	42"	122.00	
EWSR2148	48"	125.00	

24" DEPTH	CODE	LENGTH	LIST PRICE EA.
	EWSR2424	24"	\$ 105.00
EWSR2430	30"	116.00	
EWSR2436	36"	121.00	
EWSR2442	42"	125.00	
EWSR2448	48"	129.00	

Case Pack: 1 each Color: Speckled Gray (480).
Each Kit Includes: 3 rods, 1 bag with 6 closed end brackets and 2 middle brackets.

End Only Rail Kits

CODE	LENGTH	LIST PRICE EA.
EWSR14E	14"	\$ 43.00
EWSR18E	18"	44.00
EWSR21E	21"	45.00
EWSR24E	24"	47.00

Case Pack: 1 each Color: Speckled Gray (480).
Each Kit Includes: 1 end rod, 1 bag with 2 closed end brackets.

Front Only Rail Kits

CODE	LENGTH	LIST PRICE EA.
EWSR24F	24"	\$ 78.00
EWSR30F	30"	84.00
EWSR36F	36"	90.00
EWSR42F	42"	96.00
EWSR48F	48"	103.00

Case Pack: 1 each Color: Speckled Gray (480).
Each Kit Includes: 1 front rod, 1 bag with 2 closed end brackets and 2 middle brackets.



Shelf Divider Panels

- Installs directly onto shelves, front and back.
- Use to separate and organize ingredients or storage products.

CODE	DIMENSIONS D x H	LIST PRICE EA.
CSSD188	18" x 8"	\$ 22.85
CSSD218	21" x 8"	24.85
CSSD248	24" x 8"	26.90

Case Pack: 1 each Color: Soft Gray (151).

Identification Tag

- Clips directly onto front shelf traverse.
- Made of highly durable plastic with a clear front panel.

CODE	DIMENSIONS	LIST PRICE EA.
CBID6	6" x 1"	\$ 3.75

Case Pack: 12 each Color: Clear/White (000).



DUNNAGE RACKS



S-Series Dunnage Racks

Colors: Dark Brown (131),
Speckled Gray (480).

- Keep frozen, cold or dry inventory 12" safely off the floor.
- One piece construction and sturdy legs provide strength and stability.
- Heavy duty polypropylene is safe to -36°F, and will not rust, corrode or bend.
- Choose slotted tops for maximum air circulation around perishable products.
- Solid tops catch spills for easy clean up.



CODE	EXTERIOR DIMENSIONS L x D x H	LOAD CAPACITY	LIST PRICE EA.
Solid Top			
DRS30	30" x 21" x 12"	1500 lbs.	\$ 310.00
DRS36	36" x 21" x 12"	1500	337.00
DRS48	48" x 21" x 12"	3000	407.00
DRS60	60" x 21" x 12"	3000	462.00
Slotted Top			
DRS300	30" x 21" x 12"	1500	310.00
DRS360	36" x 21" x 12"	1500	337.00
DRS480	48" x 21" x 12"	3000	407.00
DRS600	60" x 21" x 12"	3000	462.00

Case Pack: 1 InStock Color: Speckled Gray (480).

Camlink®

Camlink connectors securely lock dunnage racks together for greater stability.



CODE	CASE PACK	LIST PRICE EA.
DRLNK	6	\$ 3.10

Color: Black (110).

Camlink fits all sizes and styles. One free Camlink supplied with every Dunnage Rack.



CAMBRO[®] FOOD STORAGE

Commitment to food safety relies on durable, consistent food storage products. Prep, store and serve across a wide range of temperatures and environments. All of our food storage products resist acid, oils, stains, and odors. That means years of service in a commercial kitchen without compromising quality.



The Most Efficient Food Storage System Ever



STORAGE²



Virtually unbreakable.
Withstands
temperatures from
Camwear®: -40° to 210°F
(-40° to 99°C)
Translucent: -40° to 160°F
(-40° to 70°C)



**RECESSED
HANDLES**

25%

MORE Storage Capacity



SEVEN SIZES
from 2 - 22 qt.

2 MATERIALS
Camwear &
Translucent

HELPFUL MARKS

Color graduations
are printed on
the outside for
quick inventory
management.

Graduation
marks are both
engraved and
color-printed
to ensure
long-term
readability.



with 12 to 22 qt CamSquares FreshPro containers

Note: All graduations are approximate.

FRESHNESS²



Easy Seal Cover

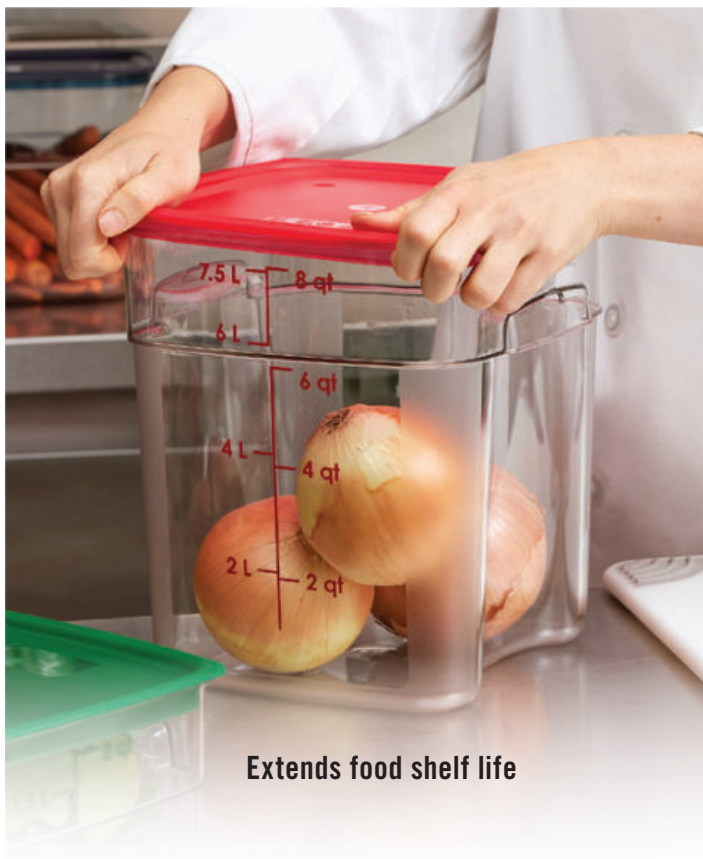

Extends food shelf life



Easy on/off cover



Prevents spills

Maximizes Freshness

Extends shelf life by
2 DAYS



INDUSTRY-FIRST

Drain shelves for square storage containers



FOOD SAFETY²



Cross stacking allows sanitary drying



Easy Seal Cover prevents cross-contamination



Peg holes on drain shelves and covers promote sanitary drying



Drain holes in handles promote sanitary drying

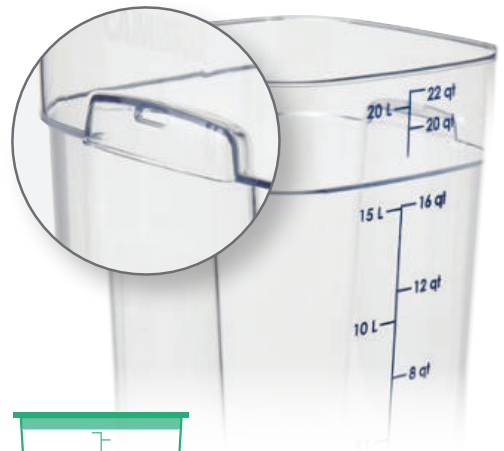

EFFICIENCY²

Color-Coded Efficiency

Matching covers, drain shelves and graduation marks



ERGONOMICS²



Curved Corners & Recessed Handles



Curved corners for safe 4-sided pouring



Ergonomic handling



Textured grip



Easy to carry

Personalization



Recipe Development



Portion Control



Inventory Management



Scan or Click for More Information

CAMWEAR® CAMSQUARE® FRESHPRO FOOD STORAGE CONTAINERS



Camwear® Polycarbonate Food Storage Containers



CODE	2SFSPROCW	4SFSPROCW	6SFSPROCW	8SFSPROCW	12SFSPROCW	18SFSPROCW	22SFSPROCW
CAPACITY	2 qt.	4 qt.	6 qt.	8 qt.	12 qt.	18 qt.	22 qt.
DIM. L x W x H	7.5" x 7.5" x 3.9"	7.5" x 7.5" x 7.2"	9" x 9" x 7.1"	9" x 9" x 9.6"	11.4" x 11.4" x 8.5"	11.4" x 11.4" x 12.9"	11.4" x 11.4" x 16"
LIST PRICE EACH	\$ 10.55	\$ 16.15	\$ 20.85	\$ 24.50	\$ 32.65	\$ 48.40	\$ 61.50

Case Pack: 6 Color: Clear (135).



Easy Seal Covers



CODE	SFC2FPPP	SFC6FPPP	SFC12FPPP
DESCRIPTION	Fits 2 & 4 qt.	Fits 6 & 8 qt.	Fits 12, 18 & 22 qt.
COLOR	Translucent Green (265)	Translucent Red (266)	Translucent Blue (267)
LIST PRICE EACH	\$ 4.50	\$ 5.60	\$ 8.15

Case Pack: 6. FreshPro Easy Seal Covers not compatible with CamSquares Classic Series Containers.

Drain Shelves

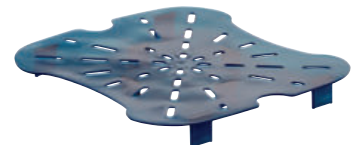
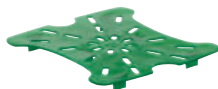

CODE	2SFSFPDPP	6SFSFPDPP	12SFSFPDPP
DESCRIPTION	Fits 2 & 4 qt.	Fits 6 & 8 qt.	Fits 12, 18 & 22 qt.
COLOR	Translucent Green (265)	Translucent Red (266)	Translucent Blue (267)
LIST PRICE EACH	\$ 4.30	\$ 5.30	\$ 6.30

Case Pack: 6. FreshPro Drain Shelves not compatible with CamSquares Classic Series Containers.

Patent Applied For

CAMWEAR® CAMSQUARES® CLASSIC SERIES FOOD STORAGE CONTAINERS



Camwear CamSquares Classic Series



CODE	2SFSCW	4SFSCW	6SFSCW	8SFSCW	12SFSCW**	18SFSCW**	22SFSCW**
CAPACITY	2 qt.	4 qt.	6 qt.	8 qt.	12 qt.	18 qt.	22 qt.
DIM. L x W x H	7¼" x 7¼" x 3⅞"	7¼" x 7¼" x 7⅝"	8⅝" x 8⅝" x 7¼"	8⅝" x 8⅝" x 9⅞"	11¼" x 12¼" x 8¾"	11¼" x 12¼" x 12⅝"	11¼" x 12¼" x 15¾"
LIST PRICE EACH	\$ 10.55	\$ 16.15	\$ 20.85	\$ 24.50	\$ 32.65	\$ 48.40	\$ 61.50

Case Pack: 6 Color/InStock Color: Clear (135). Height includes covers.



Seal Covers for Camwear CamSquares Classic Series*



CODE	SFC2SCPP	SFC6SCPP	SFC12SCPP
DESCRIPTION	Fits 2 & 4 qt.	Fits 6 & 8 qt.	Fits 12, 18 & 22 qt.
LIST PRICE EACH	\$ 4.50	\$ 5.60	\$ 8.15

Case Pack: 6 Colors: Translucent (190), Allergen Free Purple (441). InStock Color: Translucent (190). All CamSquare Seal Covers include peg hole. Seal Covers not compatible with Camwear CamSquare FreshPro Containers.



See Allergen Free Lids.

Note: All graduations are approximate.

*Seal Covers fit Camwear CamSquares Classic Series containers only and are not airtight.

**Dimensions include handles.



TRANSLUCENT CAMSQUARE® FRESHPRO FOOD STORAGE CONTAINERS



Ideal for Fresh herbs
Spice blends
Condiments
Mise en place

INDUSTRY-FIRST
Commercial Grade
One Quart and Half Quart Sizes



The Reusable and Sustainable Solution



Reusable replacement
for single-use
containers



Easy Seal Cover



- Stays firmly in place
- Prevents spills
- Extends food shelf life
- Easy on/off cover
- Peg hole for sanitary drying

One-Handed Carry



One Cover Fits Both Container Sizes



Translucent Polypropylene Food Storage Containers



HFSFSPROPP

CAPACITY: 16 oz.

DIMENSIONS L x W x H: 4.88" x 4.88" x 2.56"

LIST PRICE EACH: \$ 3.95

Case Pack: 6 **Color:** Translucent (190).



1SFSPROPP

CAPACITY: 32 oz.

DIMENSIONS L x W x H: 4.88" x 4.88" x 4.68"

LIST PRICE EACH: \$ 4.95

Case Pack: 6 **Color:** Translucent (190).

Personalization



Easy Seal Cover



SFC1FPPP

DESCRIPTION: Fits 16 & 32 oz.

LIST PRICE EACH: \$ 2.50

Case Pack: 6 **Color:** Translucent (190).

Patent Applied For

TRANSLUCENT CAMSQUARE® FRESHPRO FOOD STORAGE CONTAINERS



Translucent Polypropylene Food Storage Containers



CODE	2SFSPROPP	4SFSPROPP	6SFSPROPP	8SFSPROPP	12SFSPROPP	18SFSPROPP	22SFSPROPP
CAPACITY	2 qt.	4 qt.	6 qt.	8 qt.	12 qt.	18 qt.	22 qt.
DIM. L x W x H	7.5" x 7.5" x 3.9"	7.5" x 7.5" x 7.2"	9" x 9" x 7.1"	9" x 9" x 9.6"	11.4" x 11.4" x 8.5"	11.4" x 11.4" x 12.9"	11.4" x 11.4" x 16"
LIST PRICE EACH	\$ 9.05	\$ 12.35	\$ 15.30	\$ 18.15	\$ 25.60	\$ 34.85	\$ 42.90

Case Pack: 6 Color: Translucent (190).



Easy Seal Covers



CODE	SFC2FPPP	SFC6FPPP	SFC12FPPP
DESCRIPTION	Fits 2 & 4 qt.	Fits 6 & 8 qt.	Fits 12, 18 & 22 qt.
COLOR	Translucent Green (265)	Translucent Red (266)	Translucent Blue (267)
LIST PRICE EACH	\$ 4.50	\$ 5.60	\$ 8.15

Case Pack: 6. FreshPro Easy Seal Covers not compatible with CamSquares Classic Series Containers.

Drain Shelves

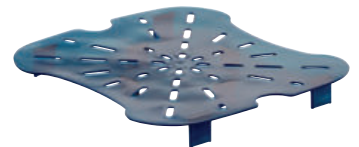
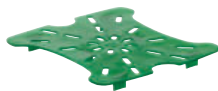

CODE	2SFSFPDPP	6SFSFPDPP	12SFSFPDPP
DESCRIPTION	Fits 2 & 4 qt.	Fits 6 & 8 qt.	Fits 12, 18 & 22 qt.
COLOR	Translucent Green (265)	Translucent Red (266)	Translucent Blue (267)
LIST PRICE EACH	\$ 4.30	\$ 5.30	\$ 6.30

Case Pack: 6. FreshPro Drain Shelves not compatible with CamSquares Classic Series Containers.

Patent Applied For



TRANSLUCENT CAMSQUARES® CLASSIC SERIES FOOD STORAGE CONTAINERS

- Translucent material provides some content visibility and high chemical resistance.
- Withstands temperatures from -40° to 160°F (-40° to 70°C).
- Easy to read graduations are printed on the outside for at a glance inventory management.

Note: All graduations are approximate.



Translucent



CODE	2SFSP	4SFSP	6SFSP	8SFSP	12SFSP**	18SFSP**	22SFSP**
CAPACITY	2 qt.	4 qt.	6 qt.	8 qt.	12 qt.	18 qt.	22 qt.
DIM. L x W x H	7¼" x 7¼" x 3⅞"	7¼" x 7¼" x 7⅞"	8⅜" x 8⅜" x 7¼"	8⅜" x 8⅜" x 9⅞"	11¼" x 12¼" x 8¾"	11¼" x 12¼" x 12⅞"	11¼" x 12¼" x 15¾"
LIST PRICE EACH	\$ 9.05	\$ 12.35	\$ 15.30	\$ 18.15	\$ 25.60	\$ 34.85	\$ 42.90

Case Pack: 6 Color/InStock Color: Translucent (190). Height includes covers.

Universal Covers*



CODE	SFC2	SFC6	SFC12
COLOR	Kelly Green (452)	Winter Rose (451)	Midnight Blue (453)
DESCRIPTION	Fits 2 & 4 qt.	Fits 6 & 8 qt.	Fits 12, 18 & 22 qt.
LIST PRICE EACH	\$ 4.50	\$ 5.60	\$ 8.15

Case Pack: 6 Colors/InStock Colors: Kelly Green (452), Winter Rose (451), Midnight Blue (453).

Note: All graduations are approximate.

*Fits all CamSquares Classic Series.

**Dimensions include handles.



Covers for Camwear®, Translucent and Poly CamSquares Classic Series

- Snap-tight polyethylene covers feature thumb tabs for easy removal.
- Colored covers match up with colored graduation marks on containers.



POLY CAMSQUARES® CLASSIC SERIES FOOD STORAGE CONTAINERS



- Economical storage choice.
- Made of impact, stain and chemical resistant opaque material.
- Withstands temperatures from -40° to 160°F (-40° to 70°C).

Note: All graduations are approximate.



Poly

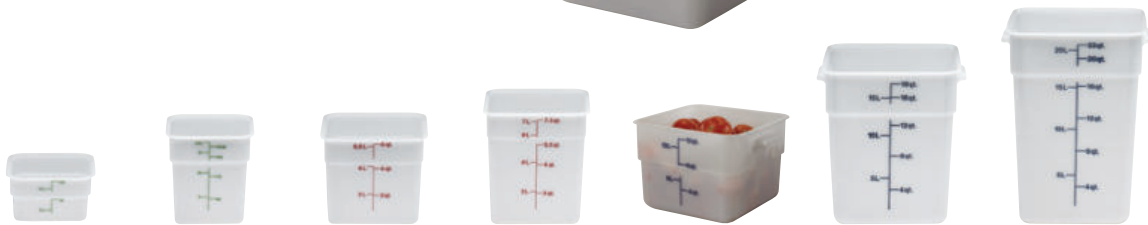

CODE	2SFSP	4SFSP	6SFSP	8SFSP	12SFSP**	18SFSP**	22SFSP**
CAPACITY	2 qt.	4 qt.	6 qt.	8 qt.	12 qt.	18 qt.	22 qt.
DIM. L x W x H	7¼" x 7¼" x 3⅞"	7¼" x 7¼" x 7⅝"	8⅜" x 8⅜" x 7¼"	8⅜" x 8⅜" x 9⅞"	11¼" x 12¼" x 8¾"	11¼" x 12¼" x 12⅝"	11¼" x 12¼" x 15¼"
LIST PRICE EACH	\$ 8.65	\$ 11.75	\$ 14.68	\$ 17.33	\$ 24.90	\$ 33.65	\$ 40.83

Case Pack: 6 Color: Natural White (148). Height includes covers.

Universal Covers*



CODE	SFC2	SFC6	SFC12
COLOR	Kelly Green (452)	Winter Rose (451)	Midnight Blue (453)
DESCRIPTION	Fits 2 & 4 qt.	Fits 6 & 8 qt.	Fits 12, 18 & 22 qt.
LIST PRICE EACH	\$ 4.50	\$ 5.60	\$ 8.15

Case Pack: 6 Colors/InStock Colors: Kelly Green (452), Winter Rose (451), Midnight Blue (453).

Note: All graduations are approximate.

*Fits all CamSquares Classic Series.

**Dimensions include handles.



Personalization

Personalize food storage products to identify menu items, add fill lines for recipes, or use personalization in multiple languages to help ensure product quality and consistency.

For more information see the "Promote Your Brand" page located in the Table section of this catalog.

CAMWEAR® ROUND FOOD STORAGE CONTAINERS



CA PROP 65 PRORATED

Store ingredients, or transport ready-to-serve, or carry partially-prepared foods. Clear Camwear allows for easy content identification at a glance. Reduce the risk of contamination and enhance food safety. Round shape promotes proper air circulation, and is ideal for stirring soups and sauces.

STRONG & CLEAR

Virtually unbreakable Camwear withstands temperatures from -40°F to 210°F (140°C to 99°C)

QUALITY, MOLDED IN

Broad, molded-in handles on the larger sizes ease carrying while the holes allow for quick and sanitary drying.



INVENTORY MANAGEMENT

Color graduations are printed on the outside for quick inventory management.

Graduation marks are both engraved AND color printed to ensure long-term readability.

STAIN-RESISTANT

Resists food acids, oils & alcohol odors and stains.

CAMWEAR COVERS

- Snap on covers fit tightly.
- Stain resistant to food acids & oils.
- Withstands temperatures from -40°F to 210°F (-40°C to 99°C).



SPILL-RESISTANCE

Inner and outer seals provide excellent spill resistance.

CAMWEAR® ROUND FOOD STORAGE CONTAINERS



Camwear



CODE	RFSCW1	RFSCW2	RFSCW4	RFSCW6	RFSCW8	RFSCW12	RFSCW18	RFSCW22
CAPACITY	1 qt.	2 qt.	4 qt.	6 qt.	8 qt.	12 qt.	18 qt.	22 qt.
DIMENSIONS	Top dia. 6 ¹ / ₁₆ " Height 5"	Top dia. 7 ¹ / ₁₆ " Height 4 ³ / ₁₆ "	Top dia. 7 ³ / ₁₆ " Height 8 ³ / ₁₆ "	Top dia. 8 ¹ / ₁₆ " Height 7 ⁵ / ₁₆ "	Top dia. 8 ¹ / ₁₆ " Height 10 ⁷ / ₈ "	Top dia. 12 ¹ / ₂ " Height 8 ³ / ₈ "	Top dia. 12 ¹ / ₂ " Height 12"	Top dia. 12 ¹ / ₂ " Height 15"
CASE PACK	12	12	12	12	12	6	6	6
LIST PRICE EACH	\$ 8.20	\$ 11.40	\$ 19.15	\$ 22.45	\$ 28.45	\$ 40.20	\$ 55.25	\$ 63.50

Color/InStock Color: Clear (135). Top diameter dimension includes handle. Height dimension includes cover. Two year warranty on Camwear rounds.



Camwear Covers

DESCRIPTION	CASE PACK	CODE	LIST PRICE EA.
Fits 1 qt.	12	RFSCWC1	\$ 3.00
Fits 2 & 4	12	RFSCWC2	5.40
Fits 6 & 8	12	RFSCWC6	6.70
Fits 12, 18 & 22	6	RFSCWC12	15.35

Color/InStock Color: Clear (135).



Seal Covers for Camwear Rounds

DESCRIPTION	CASE PACK	CODE	LIST PRICE EA.
Fits 1 qt.	12	RFS1SCPP	\$ 2.80
Fits 2 & 4	12	RFS2SCPP	4.30
Fits 6 & 8	12	RFS6SCPP	4.45
Fits 12, 18 & 22	6	RFS12SCPP	9.40

Color/InStock Color: Translucent (190).

TRANSLUCENT ROUND FOOD STORAGE CONTAINERS

- Translucent material offers some product visibility.
- Rounds are durable and resistant to stains.
- Withstands temperatures from -40° to 160°F (-40° to 70°C).
- Snap on covers fit tightly to protect contents and extend product freshness.

Note: All graduations are approximate.
Lids are not interchangeable.



Translucent

CODE	RFS1PP	RFS2PP	RFS4PP	RFS6PP	RFS8PP	RFS12PP	RFS18PP	RFS22PP
CAPACITY	1 qt.	2 qt.	4 qt.	6 qt.	8 qt.	12 qt.	18 qt.	22 qt.
DIMENSIONS	Top dia. 6 ¹ / ₁₆ " Height 5"	Top dia. 8 ³ / ₁₆ " Height 4 ³ / ₁₆ "	Top dia. 8 ³ / ₁₆ " Height 8 ³ / ₁₆ "	Top dia. 9 ¹⁵ / ₁₆ " Height 7 ¹⁵ / ₁₆ "	Top dia. 9 ¹⁵ / ₁₆ " Height 10 ⁷ / ₁₆ "	Top dia. 14 ⁷ / ₁₆ " Height 8 ⁷ / ₁₆ "	Top dia. 14 ⁷ / ₁₆ " Height 12"	Top dia. 14 ⁷ / ₁₆ " Height 15"
CASE PACK	12	12	12	12	12	6	6	6
LIST PRICE EACH	\$ 5.85	\$ 6.40	\$ 7.45	\$ 9.05	\$ 12.05	\$ 21.40	\$ 25.85	\$ 30.35

Color/InStock Color: Translucent (190). Top diameter dimension includes handle. Height dimension includes cover.



Covers for Translucent Rounds

DESCRIPTION	CASE PACK	CODE	LIST PRICE EA.
Fits 1 qt.	12	RFSC1PP	\$ 2.11
Fits 2 & 4	12	RFSC2PP	2.16
Fits 6 & 8	12	RFSC6PP	3.15
Fits 12, 18 & 22	6	RFSC12PP	7.35

Color/InStock Color: Translucent (190).

POLY ROUND FOOD STORAGE CONTAINERS



- Impact, stain and chemical resistant material.
- An affordable storage choice.
- Safe from -40° to 160°F (-40° to 70°C).
- Snap on covers fit tightly yet are easily removed.

Note: All graduations are approximate.

Note: To order Round Food Storage Containers without imprinted graduations, simply add "N" to the end of the code number.

Lids are not interchangeable.



Poly



CODE	RFS1	RFS2	RFS4	RFS6	RFS8	RFS12	RFS18	RFS22
CAPACITY	1 qt.	2 qt.	4 qt.	6 qt.	8 qt.	12 qt.	18 qt.	22 qt.
DIMENSIONS	Top dia. 6 ¹ / ₁₆ " Height 5"	Top dia. 8 ³ / ₁₆ " Height 4 ⁷ / ₁₆ "	Top dia. 8 ⁹ / ₁₆ " Height 8 ⁹ / ₁₆ "	Top dia. 9 ¹⁵ / ₁₆ " Height 7 ¹⁵ / ₁₆ "	Top dia. 9 ¹⁵ / ₁₆ " Height 10 ¹ / ₈ "	Top dia. 14 ⁷ / ₈ " Height 8 ³ / ₈ "	Top dia. 14 ⁷ / ₈ " Height 12"	Top dia. 14 ⁷ / ₈ " Height 15"
CASE PACK	12	12	12	12	12	6	6	6
LIST PRICE EACH	\$ 5.65	\$ 6.05	\$ 6.90	\$ 8.55	\$ 11.15	\$ 20.05	\$ 24.30	\$ 28.60

Color: Natural White (148). Top diameter dimension includes handle. Height dimension includes cover.



Covers for Poly Rounds

DESCRIPTION	CASE PACK	CODE	LIST PRICE EA.
Fits 1 qt.	12	RFSC1	\$ 1.85
Fits 2 & 4	12	RFSC2	1.90
Fits 6 & 8	12	RFSC6	2.80
Fits 12, 18 & 22	6	RFSC12	6.60

Color: Natural White (148).

CAMWEAR® FOOD STORAGE BOXES



Extend the freshness of ingredients and eliminate points of cross contamination by transferring product into food boxes at the receiving dock. A safe solution for storing bulk fruits and vegetables. Clear Camwear allows visibility for product identification. Snap tight Camwear Flat Lids or SlidingLids, sold separately, remain in place and won't come off during transport.

SlidingLids are covered by the following U.S. Patents D 447,906 S & 6,540,098 B1.



Available in Safety Red or Yellow to reduce the risk of cross contamination.

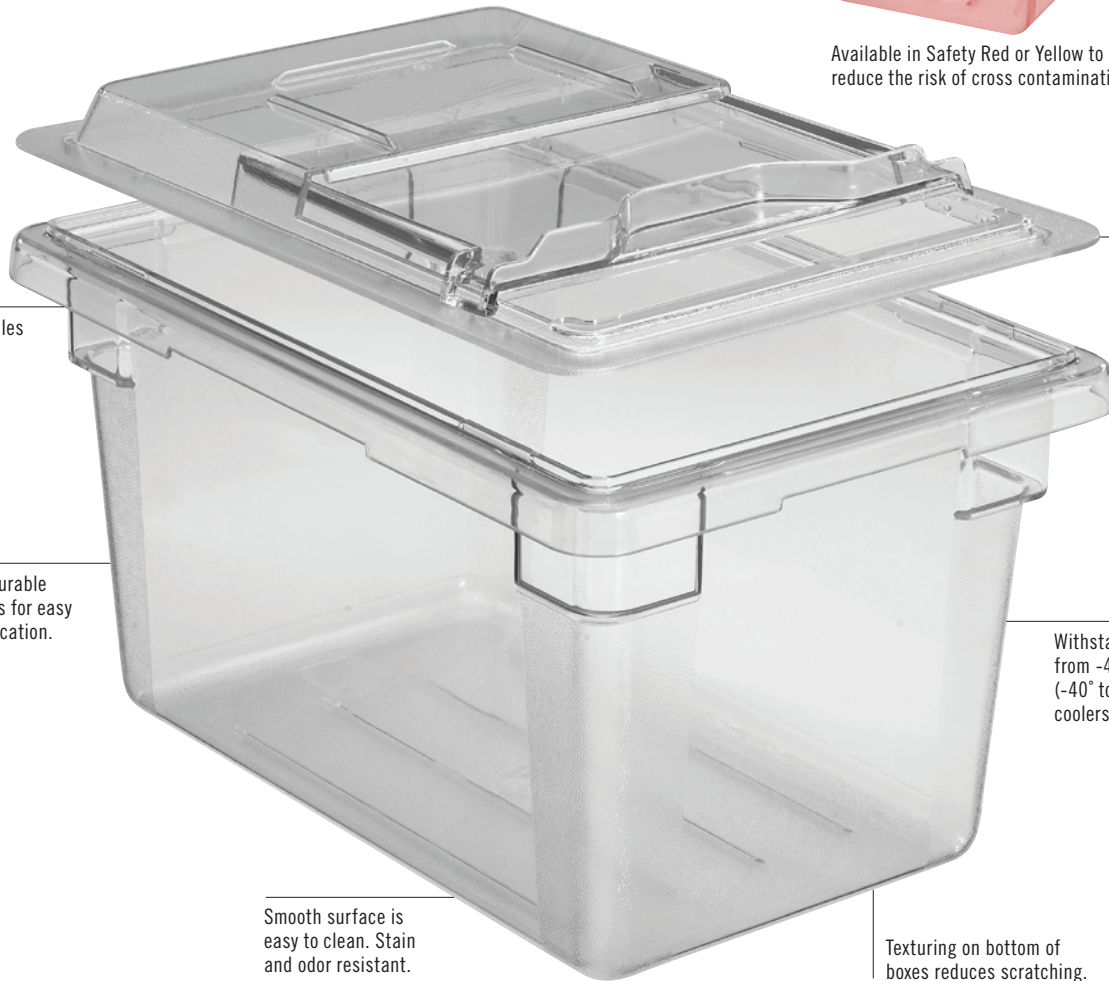

Molded-in handles ease carrying.

SlidingLid provides easy access to contents without removing the lid.

Crystal clear, durable Camwear allows for easy product identification.

Withstands temperatures from -40° to 210°F (-40° to 99°C) for use in coolers and freezers.

Smooth surface is easy to clean. Stain and odor resistant.

Texturing on bottom of boxes reduces scratching.

Camwear Flat Lids

- Snap-tight covers won't come off during transport.
- Top molded-in rails for safer, more secure stacking.
- Durable Camwear is safe from -40° to 210°F (-40° to 99°C).



Camwear SlidingLids™

- Lid slides back to easily access contents, minimizing handling.
- Reduces the risk of cross contamination since lid remains on food box.
- Made of virtually unbreakable Camwear.



CAMWEAR® FOOD STORAGE BOXES



Camwear Food Storage Boxes



CODE	18263CW	❖● 18266CW	18269CW
DIMENSIONS	18" x 26" x 3½"	18" x 26" x 6"	18" x 26" x 9"
APPROX. CAPACITY	5 gal.	8.75 gal.	13 gal.
CASE PACK	6	6	4
LIST PRICE EACH	\$ 54.25	\$ 70.25	\$ 92.50



CODE	182612CW	182615CW	12183CW	❖● 12186CW	❖ 12189CW
DIMENSIONS	18" x 26" x 12"	18" x 26" x 15"	12" x 18" x 3½"	12" x 18" x 6"	12" x 18" x 9"
APPROX. CAPACITY	17 gal.	22 gal.	1.75 gal.	3 gal.	4.75 gal.
CASE PACK	4	3	6	6	6
LIST PRICE EACH	\$ 113.00	\$ 132.25	\$ 29.70	\$ 37.60	\$ 50.75

Color/InStock Color: Clear (135). 18266CW & 12186CW are available in Safety Yellow & Red, please contact customer service for more information.

● Safety Red (467). ❖ Safety Yellow (464). Contact your Cambro representative for pricing information for Safety Red and Yellow.



Camwear Covers

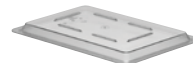

CODE	❖● 1826CCW FLAT LID	1826SCCW SLIDINGLID™	❖● 1218CCW FLAT LID	1218SCCW SLIDINGLID
DIMENSIONS	18" x 26"	18" x 26"	12" x 18"	12" x 18"
LIST PRICE EACH	\$ 36.85	\$ 66.00	\$ 18.35	\$ 39.20

Case Pack: 6 Color/InStock Color: Clear (135). 1826CCW & 1218CCW are available in Safety Yellow & Red.

● Safety Red (467). ❖ Safety Yellow (464). Contact your Cambro representative for pricing information for Safety Red and Yellow.



CAMWEAR® FOOD STORAGE BOX ACCESSORIES



ColanderKit™

- A complete food safety system packaged in one carton.
- Store raw meats, fish on ice or bulk produce safely.
- Juices and liquids drip into the food box below for quick and easy disposal.
- Reduces handling and risk of cross contamination.
- ColanderKit Includes:
 - 1 - 8" Deep Colander
 - 1 - 18" x 26" x 9" Food Box
 - 1 - 18" x 26" SlidingLid™



Camwear Colanders

- Enhances food quality and reduces risk of cross contamination.
- Liquids and juices drain directly into food box for improved food safety.
- Ideal for draining fruits and vegetables, thawing meat or poultry, or storing seafood on ice.
- Fits Camwear 18" x 26" Food Storage Boxes only.



Drain hole dimension: 3/8".

Camwear Drain Shelves

- Lifts contents out of liquids to enhance food quality and freshness.
- Made of virtually unbreakable Camwear.
- Fits Camwear and Poly Boxes.



Accessories

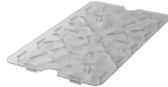

CODE	1826DSCW	1218DSCW	1826CLRCW (5" DEEP)	18268CLRCW (8" DEEP)	18268CLRKIT
DESCRIPTION	Drain shelf	Drain shelf	Colander	Colander	ColanderKit
DIMENSIONS	Fits all 18" x 26" food storage boxes	Fits all 12" x 18" food storage boxes	Fits Camwear food storage boxes only 18" x 26" x 6" and deeper	Fits Camwear food storage boxes only 18" x 26" x 9" and deeper	One 8" deep colander One 18" x 26" x 9" food box One 18" x 26" SlidingLid
CASE PACK	6	6	6	4	1 Kit
LIST PRICE EACH	\$ 30.30	\$ 12.00	\$ 58.25	\$ 100.50	\$ 255.00

Color/InStock Color: Clear (135).



FOOD STORAGE BOXES



Poly Food Storage Boxes

- Economical choice for storing bulk produce and ingredients.
- Impact, stain and chemical resistant material.
- Withstands temperatures from -40° to 160°F (-40° to 70°C).



CODE	18263P	18266P	18269P
DIMENSIONS	18" x 26" x 3½"	18" x 26" x 6"	18" x 26" x 9"
APPROX. CAPACITY	5 gal.	8.75 gal.	13 gal.
CASE PACK	6	6	6
LIST PRICE EACH	\$ 41.78	\$ 55.00	\$ 71.63



CODE	182612P	182615P	12183P	12186P	12189P
DIMENSIONS	18" x 26" x 12"	18" x 26" x 15"	12" x 18" x 3½"	12" x 18" x 6"	12" x 18" x 9"
APPROX. CAPACITY	17 gal.	22 gal.	1.75 gal.	3 gal.	4.75 gal.
CASE PACK	4	3	6	6	6
LIST PRICE EACH	\$ 87.75	\$ 102.25	\$ 25.33	\$ 31.55	\$ 41.47

Color/InStock Color: Natural White (148).

Poly Covers



CODE	1826CP FLAT LID	1218CP FLAT LID
DIMENSIONS	18" x 26"	12" x 18"
LIST PRICE EACH	\$ 32.25	\$ 19.43

Camwear and Poly Lids are not interchangeable.

Case Pack: 6 Color/InStock Color: Natural White (148).

Camchiller®

- Extend cold holding time or enhance safe holding below 41°F when frequent access is required.

CODE	CP814 (8 x 14 CAMCHILLER)
FITS INTO FOOD BOXES	12189CW, 12189P, 12186CW, 12186P
DIMENSIONS L x W x H	14" x 8" x 1½"
LIST PRICE EACH	\$ 93.25

Case Pack: 1 Color/InStock Color: Cold Blue (159).



STORESAFE® FOOD ROTATION LABELS



- Label and adhesive dissolve in less than 30 seconds.
- Leaves behind no sticky residue which can be a breeding ground for bacteria.
- Assists in a proper First In First Out (FIFO) food storage system.
- Run under hot or cold water or through the dishwasher.
- Safe for all sewer and septic systems. Will not build up in drains.
- Withstands high heat temperatures up to 200°F (93°C) for 4 hours. Microwave safe.
- Withstands freezer temperatures up to -40°F (-40°C).

Label color: White.

*Available for ordering in cases only.
No broken cartons.

100% biodegradable.
FDA approved material.



Eliminates sticky residue and prevents cross contamination! No more scraping!



Dissolves completely within 30 seconds off all containers when placed through dishwasher or under running water.



Retail Blister Pack

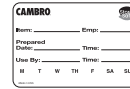

CASE CODE	23SL
LABEL SIZE	2" x 3"
CASE PACK	20 rolls, 100 labels per roll
LIST PRICE CASE	\$ 430.00

StoreSafe Label Blister Pack is covered by U.S. Patent 690,589 S.



Half Size Bulk Dispenser Pack



CASE CODE	1252SLB250	1252SLINB250
LABEL SIZE	1 1/4" x 2"	1 1/4" x 2"
CASE PACK	24 rolls, 250 labels per roll	24 rolls, 250 labels per roll
LIST PRICE CASE	\$ 399.00	\$ 399.00

Bulk Dispenser Pack

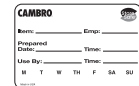
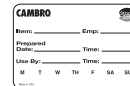

CASE CODE	23SLB250	23SLB6250
LABEL SIZE	2" x 3"	2" x 3"
CASE PACK	24 rolls, 250 labels per roll	6 rolls, 250 labels per roll
LIST PRICE CASE	\$ 800.00	\$ 207.00

Blank Bulk Dispenser Pack



CASE CODE	23SLINB250
LABEL SIZE	2" x 3"
CASE PACK	24 rolls, 250 labels per roll
LIST PRICE CASE	\$ 800.00

Laser Sheet



CASE CODE	SLL30
LABEL SIZE	1" x 2 1/2" (Avery® 5160)
CASE PACK	100 sheets, 30 labels per sheet 8 1/2" x 11" sheet size
LIST PRICE CASE	\$ 211.00





CAMWEAR® FOOD PANS



CLEARLY THE BEST

Store, transport, and serve all in one pan. Precisely designed by Gastronorm GN specifications, with a large radius bottom to reduce food waste.

Camwear pans are not recommended for steam table or microwave use. See H-Pan section for high heat applications.



UNBREAKABLE

The Camwear Food Pan is virtually unbreakable for a lasting storage solution.

CLARITY

Check contents while reducing handling and cross contamination.



HOT or NOT

Withstands a wide range of temperatures: -40°F to 210°F (-40°C to 99°C)



NO REACTION

Camwear Food Pans will not react or stain with acids or oils.

CAMWEAR® FOOD PANS



FULL SIZE

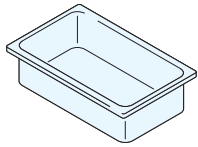

CONFIGURATIONS	PAN CODE	PAN DEPTH	APPROXIMATE CAPACITY	LIST PRICE EA.
GN 1/1 12¾" x 20⅞" (32,5 x 53 cm)	12CW	2½" (6,5 cm)	8.9 qt.	\$ 26.35
	14CW	4" (10)	13.7	33.45
	16CW	6" (15)	20.6	40.60
	18CW	8" (20)	27	48.50
	10CWD	—	Drain shelf	19.10

HALF SIZE LONG

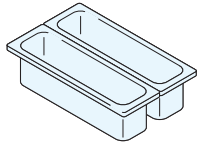

GN 1/2 Long 6⅜" x 20⅞" (16,2 x 53 cm)	22LPCW	2½" (6,5)	3.2	19.95
	24LPCW	4" (10)	5.3	24.90
	20LPCWD	—	Drain shelf	9.95

HALF SIZE

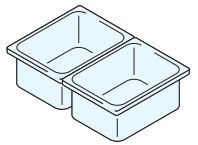

GN 1/2 10⅞" x 12¾" (26,5 x 32,5 cm)	22CW	2½" (6,5)	4.1	14.65
	24CW	4" (10)	6.3	18.20
	26CW	6" (15)	9.4	23.35
	28CW	8" (20)	12.4	29.70
	20CWD	—	Drain shelf	8.90

ONE THIRD SIZE

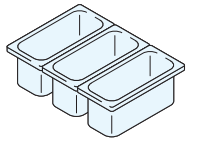

GN 1/3 6⅞" x 12¾" (17,6 x 32,5 cm)	32CW	2½" (6,5)	2.5	10.95
	34CW	4" (10)	3.8	15.05
	36CW	6" (15)	5.6	17.65
	38CW	8" (20)	7.3	22.55
	30CWD	—	Drain shelf	8.20

QUARTER SIZE

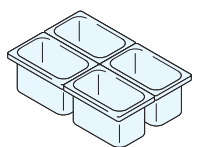

GN 1/4 6⅜" x 10⅞" (16,2 x 26,5 cm)	42CW	2½" (6,5)	1.8	11.05
	44CW	4" (10)	2.7	13.10
	46CW	6" (15)	3.9	15.05
	40CWD	—	Drain shelf	6.85

ONE SIXTH SIZE

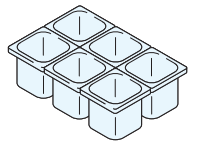

GN 1/6 6⅜" x 6⅞" (16,2 x 17,6 cm)	62CW	2½" (6,5)	1.1	8.10
	64CW	4" (10)	1.6	9.10
	66CW	6" (15)	2.4	12.25
	60CWD	—	Drain shelf	3.65

ONE EIGHTH SIZE

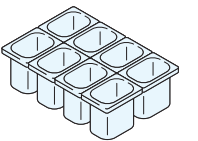

GN 1/8 6⅞" x 5⅜" (16,12 x 13,17 cm)	82CW*	2½" (6,5)	0.7	8.15
	84CW	4" (10)	1.1	9.60
	86CW	6" (15)	1.5	12.60
	80CWD	—	Drain shelf	3.25

ONE NINTH SIZE

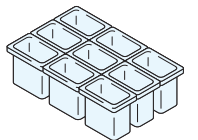

GN 1/9 4¼" x 6⅞" (10,8 x 17,6 cm)	92CW	2½" (6,5)	0.6	8.20
	94CW	4" (10)	0.9	10.00
	96PCW	6" (15)	1.4	12.50
	90CWD	—	Drain shelf	2.75

Case Pack: 6.

InStock Color: Clear (135).

96PCW InStock Color: Clear (135), Black (110).

Colors: Clear (135), White (148), Black (110). *82CW is not available in Black (110). 18CW, 28CW and Drain Shelves available in Clear (135) only.

All Camwear food pans are made of FDA approved materials. All Camwear food pans are designed to CEN Gastronorm Standard EN 631-1.



Drain Shelves

- Keeps products out of liquids and promotes drainage.
- Available for all food pan sizes.



96PCW

CAMWEAR® FOOD PAN LIDS



Flat Cover

Available in all pan sizes.



Cover with Handle

Deep molded handle provides secure grip and also includes a peg hole for sanitary drying. Available in black to help block light, reducing discoloration of meats and cheeses.



Notched Cover with Handle

Notched cover allows utensils to remain in pan and off of potentially contaminated counters. Includes peg hole for sanitary drying.



Seal Cover

Designed to fit Camwear and translucent food pans, Seal Covers feature an inner seal that provides superior spill resistance and extends shelf life up to 3 days.



FlipLid®

Flip up lid to easily access contents. Food can be held without getting dried out, increasing yields. Reduces points of cross contamination.



Notched FlipLid

FlipLid with notch to rest spoon in contents with lid closed.



GripLid®

Molded-in polyurethane gasket on the lid grips the side of the food pan airtight, reducing spills and points of cross contamination.

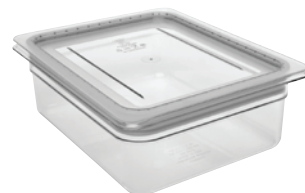

FITS PAN	LID CODE	DESCRIPTION	LIST PRICE EA.
GN 1/1 12 ³ / ₄ " x 20 ⁷ / ₈ " (32,5 x 53 cm)	10CWC	Flat cover	\$ 22.20
	10CWCH*	Cover with handle	22.20
	10CWCHN*	Notched cover w/handle	22.20
	10CWGL	GripLid	46.80
	10PPCWSC	Seal cover	15.75
GN 1/2 Long 6 ³ / ₈ " x 20 ⁷ / ₈ " (16,2 x 53 cm)	20LPCWC	Flat cover	17.00
GN 1/2 10 ¹ / ₁₆ " x 12 ³ / ₄ " (26,5 x 32,5 cm)	20CWC	Flat cover	11.65
	20CWCH*	Cover with handle	11.65
	20CWCHN*	Notched cover w/handle	13.60
	20CWL	FlipLid	18.30
	20CWLN	Notched FlipLid	18.30
	20CWGL	GripLid	32.55
	20PPCWSC	Seal cover	9.60
GN 1/3 6 ¹⁵ / ₁₆ " x 12 ³ / ₄ " (17,6 x 32,5 cm)	30CWC	Flat cover	8.50
	30CWCH*	Cover with handle	8.50
	30CWCHN*	Notched cover w/handle	11.65
	30CWL	FlipLid	15.65
	30CWLN	Notched FlipLid	15.65
	30CWGL	GripLid	20.80
	30PPCWSC	Seal cover	7.30
GN 1/4 6 ³ / ₈ " x 10 ¹ / ₁₆ " (16,2 x 26,5 cm)	40CWC	Flat cover	7.70
	40CWCH*	Cover with handle	7.70
	40CWCHN*	Notched cover w/handle	7.70
	40PPCWSC	Seal cover	6.40
GN 1/6 6 ³ / ₈ " x 6 ¹⁵ / ₁₆ " (16,2 x 17,6 cm)	60CWC	Flat cover	6.05
	60CWCH*	Cover with handle	6.65
	60CWCHN*	Notched cover w/handle	6.65
	60CWL	FlipLid	8.90
	60CWLN	Notched FlipLid	8.90
	60CWGL	GripLid	18.35
	60PPCWSC	Seal cover	4.90
GN 1/8 6 ⁵ / ₁₆ " x 5 ³ / ₁₆ " (16,12 x 13,17 cm)	80CWC	Flat cover	6.40
	80CWCH	Cover with handle	7.05
	80CWCHN	Notched cover with handle	7.05
	80PPCWSC	Seal cover	4.75
GN 1/9 4 ¹ / ₄ " x 6 ¹⁵ / ₁₆ " (10,8 x 17,6 cm)	90CWC	Flat cover	6.80
	90CWCN	Flat notched cover	6.80
	90CWL*	FlipLid cover	7.95
	90CWLN*	Notched FlipLid cover	7.95
	90PPCWSC	Seal cover	4.50

Case Pack for all Lids: 6 InStock Color: Clear (135).

*Includes peg hole.

Color: Clear (135).

Seal Cover Color: Translucent (190).

Cover with Handle Colors: Clear (135), Black (110).

FlipLids are covered by U.S. Patent D 420,849, D 422,838 & D 427,012.

GripLids are covered by U.S. Patent D 446,076 & Utility Patent 6,273,288 B1.



CAMWEAR® COLANDER PANS



- Rinse, drain and store all in one pan.
- Liquids drain easily into the food pan below for enhanced food quality and reduced handling.
- Colanders simply lift out of the food pan for safe and quick disposal of liquids.
- Ideal for prepped produce, storing seafood on ice, and defrosting and storing meats and poultry.
- Camwear flat covers, covers with handles and notched covers with handles fit on pans with colanders.

Colander Pans are covered by U.S. Patent D 569,169 S.



Drain hole dimension: 1/4".

13CLRCW with 14CW Food Pan.



Rinse



Drain



Store

CONFIGURATIONS	PAN CODE	COLANDER DEPTH	FITS CAMWEAR PAN DEPTH	LIST PRICE EA.
GN 1/1 12 ³ / ₄ " x 20 ⁷ / ₈ " (32,5 x 53 cm)	13CLRCW	3" (7,6 cm)	4" (10 cm)	\$ 33.45
	15CLRCW	5" (12,7)	6" (15)	40.60
GN 1/2 10 ⁷ / ₁₆ " x 12 ³ / ₄ " (26,5 x 32,5 cm)	23CLRCW	3" (7,6)	4" (10)	18.20
	25CLRCW	5" (12,7)	6" (15)	23.35
GN 1/3 6 ¹⁵ / ₁₆ " x 12 ³ / ₄ " (17,6 x 32,5 cm)	33CLRCW	3" (7,6)	4" (10)	15.05
	35CLRCW	5" (12,7)	6" (15)	17.65
GN 1/6 6 ³ / ₈ " x 6 ¹⁵ / ₁₆ " (16,2 x 17,6 cm)	63CLRCW	3" (7,6)	4" (10)	9.10
	65CLRCW	5" (12,7)	6" (15)	12.25

Case Pack: 6 Color: Clear (135). Lids listed on previous page.



H-PAN™ HIGH HEAT FOOD PANS



Store, transport, and serve all in one pan. Precisely designed by Gastronorm GN specifications, with a large radius bottom to reduce food waste.



375°F

Withstands temperatures from -40°F to 375°F

-40°F

ONE PAN THAT DOES IT ALL



GOES FROM...



PREP



OVEN



FREEZER



MICROWAVE



STEAM TABLE



Pan edges are **COOL** to the touch for safe handling

PANS STACK

H-PAN™ HIGH HEAT FOOD PANS



FULL SIZE

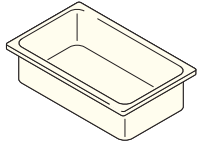

CONFIGURATIONS	PAN CODE	PAN DEPTH	APPROXIMATE CAPACITY	LIST PRICE EA.
GN 1/1 12¾" x 20⅞" (32,5 x 53 cm)	12HP	2½" (6,5 cm)	8.9 qt.	\$ 74.00
	14HP	4" (10)	13.7	89.50
	16HP	6" (15)	20.6	116.00
	10HPD	—	Drain shelf	48.95

HALF SIZE LONG

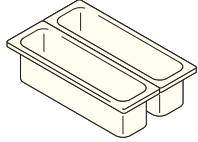

GN 1/2 Long 6⅞" x 20⅞" (16,2 x 53 cm)	22LPHP	2½" (6,5)	3.2	52.50
	24LPHP	4" (10)	5.3	65.50
	20LPHPD	—	Drain shelf	24.45

HALF SIZE

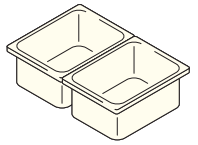

GN 1/2 10⅞" x 12¾" (26,5 x 32,5 cm)	22HP	2½" (6,5)	4.1	36.85
	24HP	4" (10)	6.3	47.85
	26HP	6" (15)	9.4	61.50
	20HPD	—	Drain shelf	21.95

ONE THIRD SIZE

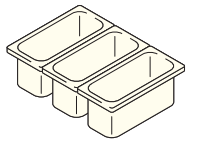

GN 1/3 6⅞" x 12¾" (17,6 x 32,5 cm)	32HP	2½" (6,5)	2.5	30.80
	34HP	4" (10)	3.8	39.90
	36HP	6" (15)	5.6	54.50
	30HPD	—	Drain shelf	16.50

QUARTER SIZE

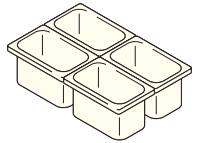

GN 1/4 6⅞" x 10⅞" (16,2 x 26,5 cm)	42HP	2½" (6,5)	1.8	26.75
	44HP	4" (10)	2.7	33.00
	46HP	6" (15)	3.9	42.20
	40HPD	—	Drain shelf	16.50

ONE SIXTH SIZE

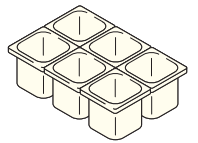

GN 1/6 6⅞" x 6⅞" (16,2 x 17,6 cm)	62HP	2½" (6,5)	1.1	20.85
	64HP	4" (10)	1.6	25.20
	66HP	6" (15)	2.4	30.55
	60HPD	—	Drain shelf	8.50

ONE EIGHTH SIZE

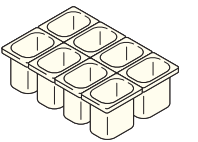

GN 1/8 6⅞" x 5⅞" (16,12 x 13,17 cm)	82HP	2½" (6,5)	0.7	18.30
	84HP	4" (10)	1.1	23.10
	86HP	6" (15)	1.5	29.85
	80HPD	—	Drain shelf	7.45

ONE NINTH SIZE

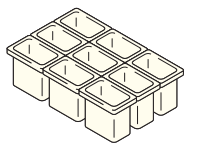

GN 1/9 4¼" x 6⅞" (10,8 x 17,6 cm)	92HP	2½" (6,5)	0.6	15.80
	94HP	4" (10)	0.9	18.45
	96PHP	6" (15)	1.4	26.20
	90HPD	—	Drain shelf	6.30

Case Pack: 6 InStock Color: Amber (150).

Colors: Amber (150), Black (110).
Drain Shelf Color: Amber (150).

H-Pans are made of FDA approved material and are designed to CEN Gastronorm Standard EN 631-1. Amber color may vary.

Microwave safe.



Drain Shelf

- Supports product and promotes drainage.
- Available to fit all food pan sizes.



86HP
Shown with Optional Drain Shelf.

H-PAN™ HIGH HEAT FOOD PAN LIDS



FITS PAN	LID CODE	DESCRIPTION	LIST PRICE EA.
GN 1/1 12 ³ / ₄ " x 20 ⁷ / ₈ " (32,5 x 53 cm)	10HPC*	Flat cover	\$ 66.50
	10HPCH*	Cover with handle	66.50
	10HPCHN*	Notched cover w/handle	66.50

GN 1/2 Long 6 ³ / ₈ " x 20 ⁷ / ₈ " (16,2 x 53 cm)	20LPHPC	Flat cover	39.55
---	---------	------------	-------

GN 1/2 10 ⁷ / ₁₆ " x 12 ³ / ₄ " (26,5 x 32,5 cm)	20HPC*	Flat cover	28.85
	20HPCH*	Cover with handle	30.60
	20HPCHN*	Notched cover w/handle	35.05
	20HPL	FlipLid	51.00
	20HPLN	Notched FlipLid	51.00

GN 1/3 6 ¹⁵ / ₁₆ " x 12 ³ / ₄ " (17,6 x 32,5 cm)	30HPC*	Flat cover	21.55
	30HPCH*	Cover with handle	24.35
	30HPCHN*	Notched cover w/handle	24.35
	30HPL	FlipLid	36.30
	30HPLN	Notched FlipLid	36.30

GN 1/4 6 ³ / ₈ " x 10 ⁷ / ₁₆ " (16,2 x 26,5 cm)	40HPC*	Flat cover	17.50
	40HPCH*	Cover with handle	18.85
	40HPCHN*	Notched cover w/handle	19.05

GN 1/6 6 ³ / ₈ " x 6 ¹⁵ / ₁₆ " (16,2 x 17,6 cm)	60HPC*	Flat cover	15.30
	60HPCH*	Cover with handle	15.30
	60HPCHN*	Notched cover w/handle	15.30
	60HPL	FlipLid	20.80
	60HPLN	Notched FlipLid	20.80

GN 1/8 6 ⁷ / ₁₆ " x 5 ³ / ₁₆ " (16,12 x 13,17 cm)	80HPC*	Flat cover	12.85
	80HPCH*	Cover with handle	12.85
	80HPCHN*	Notched cover w/handle	12.85

GN 1/9 4 ¹ / ₄ " x 6 ¹⁵ / ₁₆ " (10,8 x 17,6 cm)	90HPC*	Flat cover	10.50
	90HPL	FlipLid	20.00

Case Pack: 6 InStock Color: Amber (150).
*Includes peg hole.

Notched FlipLid®

Flip Lid with notch to rest spoon in contents with lid closed.



FlipLid®

Flip up lid to easily access contents. Food can be held without getting dried out, increasing yields.



Flat Cover

Available in all pan sizes.



Cover with Handle

Deep molded handle gives secure grip.



Notched Cover with Handle

Easy access for ladles or spoons.

Color: Amber (150).
Amber color may vary.

Microwave safe.

FlipLids are covered by U.S. Patent D 420,849, D 422,838 & D 427,012 & Patent 6,273,288 B1.



H-PAN™ HIGH HEAT COLANDER PANS



- Colanders drain liquids and grease away from hot foods, improving food quality.
- Ideal for reheating in microwaves and holding applications such as steam tables and buffet lines.
- Reduces handling and improves food safety.
- H-Pan High Heat Flat Covers, Covers with Handles and Notched Covers with Handles fit on pans with colanders.



Microwave/Steam



Hold Hot Foods



Drain

CONFIGURATIONS	PAN CODE	COLANDER DEPTH	FITS H-PAN DEPTH	LIST PRICE EA.
GN 1/1 12 ³ / ₄ " x 20 ⁷ / ₈ " (32,5 x 53 cm)	13CLRHP	3" (7,6 cm)	4" (10 cm)	\$ 89.50
	15CLRHP	5" (12,7)	6" (15)	116.00
GN 1/2 10 ⁷ / ₁₆ " x 12 ³ / ₄ " (26,5 x 32,5 cm)	23CLRHP	3" (7,6)	4" (10)	46.20
	25CLRHP	5" (12,7)	6" (15)	61.50
GN 1/3 6 ¹⁵ / ₁₆ " x 12 ³ / ₄ " (17,6 x 32,5 cm)	33CLRHP	3" (7,6)	4" (10)	39.90
	35CLRHP	5" (12,7)	6" (15)	54.50
GN 1/6 6 ³ / ₈ " x 6 ¹⁵ / ₁₆ " (16,2 x 17,6 cm)	63CLRHP	3" (7,6)	4" (10)	25.20
	65CLRHP	5" (12,7)	6" (15)	30.55

Case Pack: 6 Color: Amber (150). Lids listed on previous page.



HIGH HEAT H-PAN™ WITH HANDLE(S)



- Flat base to maximize contact with heating element.
- High heat material withstands temperatures from -40° to 375°F (-40° to 190°C).
- Fits all leading manufacturer's product holding units (PHU), including single-sided and pass-through models.
- Reinforced textured handle design with finger grip feature for a secure grasp.
- Handle designed with drain holes to avoid water build-up after warewashing process.
- Two handles allow employees to reach the pan from either side of the unit for safe handling.
- Can be used with high heat lids and drain shelves.

Color: Amber (150).

32HP2H is covered by U.S. Patent D797,493 S.



34HP2H



32HP1H

CONFIGURATIONS	PAN CODE	DESCRIPTION	PAN DEPTH	APPROX. CAPACITY	LIST PRICE EA.
1/3 6 ¹ / ₁₆ " x 12 ³ / ₄ " (17,6 x 32,5 cm)	32HP1H	Single Handle	2 ¹ / ₂ " (6,5 cm)	2.5 qt.	\$ 47.25
	32HP2H	Double Handle	2 ¹ / ₂ " (6,5)	2.5	48.40
	34HP1H	Single Handle	4" (10)	3.8	59.75
	34HP2H	Double Handle	4" (10)	3.8	61.25

Case Pack: 6 **Color/InStock Color:** Amber (150).

High Heat Flat Cover,
Cover with Handle and
Notched Cover with Handle
fit on pan.

Full size 2¹/₂" deep food pan with
handles fits all leading product
holding units (PHU).



12HPH

CONFIGURATIONS	PAN CODE	PAN DEPTH	APPROX. CAPACITY	LIST PRICE EA.
1/1 12 ³ / ₄ " x 20 ⁷ / ₈ " (32,5 x 53 cm)	12HPH	2 ¹ / ₂ " (6,5 cm)	8.9 qt.	\$ 85.00

Case Pack: 6 **Color/InStock Color:** Amber (150).
Lids listed on previous page.

TRANSLUCENT FOOD PANS



- An economical choice for storing food.
- Translucent polypropylene material provides content visibility and high chemical resistance.
- Withstands temperature ranges from -40° to 160°F (-40° to 70°C).
- Meets Gastronorm GN food pan specifications EN-631-1.
- Non-stick smooth interior surface promotes easy cleaning.

Color: Translucent (190).
 Graduation marks and capacities are approximate.
 Translucent food pans are made of FDA approved materials.
 Translucent food pans interstack with other Cambro food pans.
 Translucent pans are not designed for steam table use.



Ideal for transporting in Cambro top loading carriers. (UPC100, UPCS140, 100MPC, UPC140, UPCS160, 240MPC, UPC160, EPP160SW, EPP180SW, EPP260SW, EPP280SW)



Seal covers protect food quality while eliminating the expense of plastic wrap.



Uniform 1/2" (1,27 cm) flange width ensures the right fit in prep tables and food bars.



Use Cambro StoreSafe® food rotation labels on translucent food pans to manage inventory and reduce waste.

TRANSLUCENT COLANDER PANS

- Rinse, drain and store all in one pan.
- Liquids drain easily into the food pan below for enhanced food quality and reduced handling.
- Translucent Cover w/Handle and Notched Cover with Handle fit on pans with colanders.
- Drain hole diameter is approximately 1/4".

Color: Translucent (190).
 Translucent colander pans are made of FDA approved materials.
 Translucent pans are not designed for steam table use.



CONFIGURATIONS	PAN CODE	COLANDER DEPTH	FITS TRANSLUCENT PAN DEPTH	LIST PRICE EA.
GN 1/3 6 ¹⁵ / ₁₆ " x 12 ³ / ₄ " (17,6 x 32,5 cm)	33CLRPP 35CLRPP	3" (7,6 cm) 5" (12,7)	4" (10 cm) 6" (15)	\$ 10.80 12.40
GN 1/6 6 ³ / ₈ " x 6 ¹⁵ / ₁₆ " (16,2 x 17,6 cm)	63CLRPP 65CLRPP	3" (7,6) 5" (12,7)	4" (10) 6" (15)	6.95 7.90

Case Pack for all Pans: 6. **Color:** Translucent (190). Lids listed on following page.

TRANSLUCENT FOOD PANS



FULL SIZE

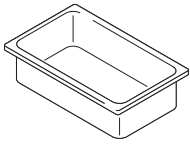

CONFIGURATIONS	PAN CODE	PAN DEPTH	APPROXIMATE CAPACITY	LIST PRICE EA.
GN 1/1 12 ³ / ₄ " x 20 ⁷ / ₈ " (32,5 x 53 cm)	12PP	2 ¹ / ₂ " (6,5 cm)	7.5 qt.	\$ 17.20
	14PP	4" (10)	13.7	21.70
	16PP	6" (15)	20.6	27.80
	18PP	8" (20)	27	37.35
	10PPD	—	Drain shelf	12.35

HALF SIZE

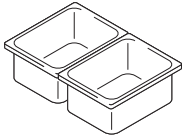

GN 1/2 10 ¹ / ₁₆ " x 12 ³ / ₄ " (26,5 x 32,5 cm)	22PP	2 ¹ / ₂ " (6,5)	4.1	10.55
	24PP	4" (10)	6.3	13.00
	26PP	6" (15)	9.4	16.90
	28PP	8" (20)	12.4	22.25
	20PPD	—	Drain shelf	6.40

ONE THIRD SIZE

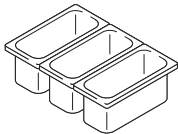

GN 1/3 6 ¹⁵ / ₁₆ " x 12 ³ / ₄ " (17,6 x 32,5 cm)	32PP	2 ¹ / ₂ " (6,5)	2.5	7.95
	34PP	4" (10)	3.8	10.80
	36PP	6" (15)	5.6	12.40
	38PP	8" (20)	7.3	16.10
	30PPD	—	Drain shelf	6.00

QUARTER SIZE

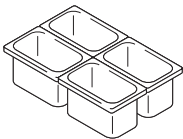

GN 1/4 6 ³ / ₈ " x 10 ⁷ / ₁₆ " (16,2 x 26,5 cm)	42PP	2 ¹ / ₂ " (6,5)	1.8	7.95
	44PP	4" (10)	2.7	9.30
	46PP	6" (15)	3.9	10.80
	40PPD	—	Drain shelf	5.00

ONE SIXTH SIZE

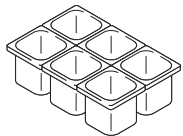

GN 1/6 6 ³ / ₈ " x 6 ¹⁵ / ₁₆ " (16,2 x 17,6 cm)	62PP	2 ¹ / ₂ " (6,5)	1.1	6.15
	64PP	4" (10)	1.6	6.95
	66PP	6" (15)	2.4	9.10
	60PPD	—	Drain shelf	3.35

ONE NINTH SIZE

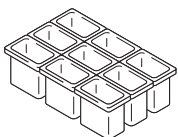

GN 1/9 4 ³ / ₄ " x 6 ¹⁵ / ₁₆ " (10,8 x 17,6 cm)	92PP	2 ¹ / ₂ " (6,5)	0.6	6.40
	94PP	4" (10)	0.9	7.90
	90PPD	—	Drain shelf	2.22

Case Pack: 6 Color/InStock Color: Translucent (190).

Color: Translucent (190).

All translucent food pans are made of FDA approved materials.

All translucent polypropylene GN Food Pans are designed to CEN Gastronorm Standard EN 631-1.



Drain Shelves

- Keeps products out of liquids and promotes drainage.
- Available for all pan sizes.



TRANSLUCENT FOOD PAN LIDS



Seal Cover

Designed to fit Camwear® and translucent food pans, Seal Covers feature an inner seal that provides superior spill resistance and extends shelf life up to 3 days. Available for all food pan sizes.



FITS PAN	LID CODE	DESCRIPTION	LIST PRICE EA.
GN 1/1 12¾" x 20⅞" (32,5 x 53 cm)	10PPCH	Cover with handle	\$ 16.10
	10PPCWSC	Seal cover	15.75

GN 1/2 10⅞" x 12¾" (26,5 x 32,5 cm)	20PPCH	Cover with handle	11.05
	20PPCWSC	Seal cover	9.60

Cover with Handle

Deep molded handle gives secure grip. Available for all food pan sizes except 1/9.



GN 1/3 6⅞" x 12¾" (17,6 x 32,5 cm)	30PPCH	Cover with handle	7.65
	30PPCHN	Notched cover w/handle	9.40
	30PPCWSC	Seal cover	7.30

GN 1/4 6⅞" x 10⅞" (16,2 x 26,5 cm)	40PPCH	Cover with handle	7.45
	40PPCWSC	Seal cover	6.40

Notched Cover with Handle

Easy access for ladles or spoons. Available for 1/3 and 1/6 food pans.



GN 1/6 6⅜" x 6⅞" (16,2 x 17,6 cm)	60PPCH	Cover with handle	6.45
	60PPCHN	Notched cover w/handle	7.05
	60PPCWSC	Seal cover	4.90

Flat Cover

Only available for 1/9 food pans.



GN 1/9 4¼" x 6⅞" (10,8 x 17,6 cm)	90PPC	Flat cover	5.65
	90PPCWSC	Seal cover	4.50

Case Pack: 6 Color/InStock Color: Translucent (190).

Color: Translucent (190).

All translucent food pan lids are made of FDA approved materials.



COLDFEST® GASTRONORM PANS, CROCKS, COVERS & PUMPS



- Keeps contents chilled at or below HACCP guidelines of 41°F (4°C) without the use of messy ice.
- Freeze upside down for eight hours or overnight before filling with pre-chilled product.
- Half and third-size pans hold contents cold for up to eight hours. Sixth size pans and crocks hold contents cold for up to six hours.
- Conforms to Gastronorm exterior dimensions to fit standard food bars or make tables.
- Stackable to save space when freezing and storing.
- Can be used for direct food contact with all types of food products.

Colors: Black (110), White (148).
Flat Cover Color: Clear (135).
Seal Cover Color: White (148).
Pump with Cover Color: Clear (135).

Suggested holding times are based on tests with ambient room conditions of up to 74°F (23°C).

ColdFest is covered under U.S. Patent D 419,364.

*Pumps and Round Covers are Not NSF Listed.



Ideal for use with Cambro Versa Food Bars® to keep perishable items chilled.

Pans / Crock



CODE	26CF	36CF	66CF	CFR18
CONFIGURATIONS	GN 1/2 – 10¼" x 12¾"	GN 1/3 – 6½" x 12¾"	GN 1/6 – 6¾" x 6¾"	Dia. 6½"
DEPTH	6"	6"	6"	6¾"
APPROX. CAPACITY	6.5 qt.	3.7 qt.	1.5 qt.	1.7 qt.
LIST PRICE EACH	\$ 76.75	\$ 57.75	\$ 39.25	\$ 42.60

Case Pack: 1 InStock Color: White (148).



ColdFest Food Pans are made with high-impact resistant ABS shells and non-toxic refrigerant gel cores.

Covers



CODE	20CFC	30CFC	60CFC	CFRC18*	CFRSC18
DESCRIPTION	Flat cover	Flat cover	Flat cover	Flat cover	Seal cover
FITS COLDFEST	GN 1/2	GN 1/3	GN 1/6	Crock	Crock
LIST PRICE EACH	\$ 19.40	\$ 16.25	\$ 8.70	\$ 31.10	\$ 7.05

Case Pack: 2 InStock Color: Clear (135).



Pumps with Clear Covers



CODE	CFPSRC10*	CFPMRC10*	CFPFR10*
DESCRIPTION	Standard pump for 1 oz. portions	Maxi pump for chunky condiments	Fixed nozzle pump for controlled dispensing
DIMENSIONS W x D x H	7¼" x 9" x 11¼"	7¼" x 10¼" x 12¾"	7¼" x 11½" x 11¾"
LIST PRICE EACH	\$ 20.45	\$ 48.50	\$ 48.10

Case Pack: 1



PIZZA DOUGH BOXES AND PIZZA DOUGH BOX CAMDOLLY®



DB18263P



Polypropylene

- Ideal for storing, transporting, proofing and cooling dough.
- Lightweight, durable, and break resistant.
- Chemical resistant material won't absorb odors and is easy to clean.
- Boxes nest tightly together to keep out dirt and contaminants, extending product freshness.

- Each box acts as a tight lid for the box below, reducing the need and expense of covers.
- Withstands temperatures from -40° to 160°F.*
- Cover can be used as an 18" x 26" tray.
- Available in 3" depth only.

Color: White (148).

Camwear & Polypropylene dough boxes do not inter stack.

*Polypropylene dough boxes are safe for use in high temperature dishwashers.

Camdolly Caster: 5" Casters: 2 fixed, 2 swivel, 1 with brake.



CD1826PDB

Weight Capacity: 300 lbs.



Camwear®

- Prevents crusting to increase the storage life of dough.
- Virtually unbreakable Camwear construction is reinforced on all sides.
- Boxes won't bend or lose their shape.

- Withstands temperatures from -40° to 210°F.
- Available in 3" and 6" depths.



DB18266CW

DB18263CW

CODE	OUTSIDE DIMENSIONS INSIDE DIMENSIONS	CASE PACK	LIST PRICE EA.
Polypropylene Pizza Dough Box			
DB18263P	18" x 26" x 3" 16" x 24"	6	\$ 53.00
Polypropylene Cover			
DBC1826P	18" x 26"	6	35.60
Camwear Pizza Dough Boxes			
DB18263CW	18" x 26" x 3" 16" x 24"	6	60.75
DB18266CW	18" x 26" x 6" 16" x 24"	6	81.75
Camwear Cover			
DBC1826CW	18" x 26"	6	44.30
Camdolly For Pizza Dough Boxes			
CD1826PDB**	19 ⁷ / ₁₆ " x 27 ⁷ / ₁₆ " x 10 ¹ / ₄ " 17 ⁷ / ₁₆ " x 25 ³ / ₈ "	1	483.00

InStock Color: White (148). **Optional straps (400STP or UTHSTP) sold separately.
Camdolly Colors: Black (110), Charcoal Grey (615), Dark Brown (131), Coffee Beige (157), Slate Blue (401).

INGREDIENT BINS AND CAMWEAR® DRY SCOOPS



Ingredient Bins

- Store bulk dry ingredients such as flour and grain.
- Hygienic clear sliding lid reduces handling and allows for quick content identification.
- Bin made of FDA-accepted material so no liners are needed.
- Designed to fit under standard work tables.

3" Casters: 2 rear fixed, 2 front swivel.

Color: White (148).

Cover Color: Clear (135).

Scoops sold separately.

IBSH24 Scoop Holder comes with IBS20, IBS27 and IBSF27 Ingredient Bins only.



IBSF27



IBSH24

Holder for IBS20, IBS27 & IBSF27

CAPACITY: Up to 24oz.

LIST PRICE EA.: \$12.00



IBS20



IBS27



IBS37



IB32



IB36



IB44

CODE	DIMENSIONS W x L x H	LIQUID CAPACITY	LID TYPE	DRY CAPACITY (SUGAR)	DRY CAPACITY (FLOUR)	LIST PRICE EA.
IBS20	13" x 29½" x 28"	21 gal.	Two Piece Sliding Lid	170 lbs.	140 lbs.	\$ 494.00
IBS27	16⅞" x 29⅝" x 28"	27	Two Piece Sliding Lid	226	150	510.00
IBS37	21½" x 29½" x 28¼"	37	Two Piece Sliding Lid	314	225	580.00
IBSF27	13" x 30⅞" x 28½"	26.7	Two Piece Sliding Lid	216	150	530.00
IB32	22" x 24" x 23"	32	Single Flat Lid	215	160	560.00
IB36	15¼" x 29½" x 29"	34	Single Flat Lid	252	180	580.00
IB44	18½" x 29½" x 29"	42.5	Single Flat Lid	320	230	590.00

Case Pack: 1 InStock Color: White (148).

Camwear Dry Scoops

- Virtually unbreakable Camwear will not dent, chip or rust.
- Molded-in sure grip handle includes a hole for hanging.
- Ideal for use with Cambro Ice Caddies and Ingredient Bins.

Color: Clear (135).



CODE	APPROX. CAPACITY	CASE PACK	LIST PRICE EA.
SCP6CW	6 oz.	12	\$ 8.30
SCP12CW	12	12	8.95
SCP24CW	24	12	11.40
SCP64CW	64	6	16.20

InStock Color: Clear (135).

SOAK AND BRINE TANK & CAMCRISPER®



Soak and Brine Tank

- Designed for complete submersion of meats or poultry in brining solution for enhanced moisture retention, texture and flavor.
- Can also be used as a pre-soak tank for smallwares and dishes in sanitation solution to help reduce labor in pre-scrubbing.
- Clear sliding lid always stays on to help reduce the risk of cross contamination.
- Withstands temperatures from -40° to 160°F (-40° to 70°C).

3" Casters: 2 rear fixed, 2 front swivel.

Colors: White (148), Yellow (229).

Cover Color: Clear (135).

Some assembly required.



Maneuverable drain elbow can be positioned in any direction as needed. Use with or without drain hose based on available access to floor drain.

Tank drains easily in 4 minutes when completely full and features an easy to turn 45° ball valve.

Maneuverable drain elbow and clear hose allow drainage even with hard to access drains.

CODE	DIMENSIONS W x L x H	CAPACITY	CUBIC FEET	LIST PRICE EA.
IBSD37	21½" x 29½" x 28¼"	37 gal.	5.55	\$ 935.00

Case Pack: 1

Camcrisper

- A self-contained system for brining or storing, washing and transporting bulk produce.
- Prevents cross contamination and minimizes unnecessary handling.
- Transfer dry produce out of cartons into bin, cover and roll into cooler for safe storage.
- Wash and rinse produce for easy and safe prep.

3" Casters: 2 rear fixed, 2 front swivel.

Color: White (148).

Cover Color: Clear (135).



CODE	DIMENSIONS W x L x H	CAPACITY	CUBIC FEET	LOAD CAPACITY	LIST PRICE EA.
CC32	22" x 24" x 23"	32 gal.	4.28	24 lettuce heads (unfinished) 42 lettuce heads (finished)	\$ 820.00

Case Pack: 1

HIGH HEAT MEASURING CUPS AND CAMWEAR® MEASURING CUPS



High Heat Measuring Cups and Cover

- Use to heat liquids or sauces in the microwave, collect hot water from a dispenser, fill steam tables or chafing dishes or rehydrate food products.
- Withstands temperatures ranging from -40° to 375°F (-40° to 190°C).
- Will not crack or shatter from regular use with hot liquids/ingredients.

- Molded-in standard and metric graduations ensure accuracy and will hold up to the rigors of foodservice.
- Molded-in handle is positioned for both comfort and safety, and stays cool to the touch out of the microwave or oven.
- Optional Splatter-Proof Cover fits both 2 and 4 qt. measuring cups.

Color: Amber (150).



Cups shown with Optional Universal Cover.

CODE	DESCRIPTION	DIMENSIONS DIA x H	LIST PRICE EA.
200MCH	2 qt. Measuring Cup	7 ⁷ / ₁₆ " x 6 ³ / ₈ "	\$ 46.20
400MCH	4 qt. Measuring Cup	7 ⁷ / ₁₆ " x 10 ³ / ₈ "	69.20
MCCH	Universal Cover (fits both cups)	7 ⁷ / ₁₆ " x 15 ¹ / ₁₆ "	18.45

Case Pack: 1

Camwear® Liquid Measuring Cups

- Externally marked graduations are molded in and imprinted in red for American standard and blue for metric for easy measurement.
- Durable, virtually unbreakable Camwear will not dent, ensuring an accurate measurement every time.
- Molded-in handle will not break off.

Color: Clear (135).



CODE	CAPACITY	CASE PACK	LIST PRICE EA.
25MCCW	1 cup (dry measure)	12	\$ 8.10
50MCCW	1 pt.	12	15.00
100MCCW	1 qt.	12	16.90
200MCCW	2	12	23.30
400MCCW	4	1	25.30

InStock Color: Clear (135).

ALLERGEN MANAGEMENT



Camwear® CamSquare® Storage Containers and Covers

- Personalized containers include easy-to-identify purple graduations and Allergen-Free imprint on the opposite side.
- Purple Seal Covers feature an inner and outer seal to help keep ingredients safe from cross contamination, even during transport.



**Allergen 6 qt. Container: 6SFSCW441
Lid: SFC6SCPP441**

Trays

- Protect your customers from the risk of allergenic foods by keeping color coded Allergen-Free trays on hand.



1418 Camtray®
Grape (551).

Liquid Measuring Cups

- Externally marked purple graduations and Allergen-Free logo are imprinted in Allergen purple for easy identification.



100MCCW441

CODE	DESCRIPTION	CASE PACK	LIST PRICE EA.
Allergen-Free Camwear CamSquares			
2SFSCW441	2 qt.	6	\$ 11.65
4SFSCW441	4 qt.	6	17.75
6SFSCW441	6 qt.	6	22.90
8SFSCW441	8 qt.	6	26.95
12SFSCW441	12 qt.	6	35.90
18SFSCW441	18 qt.	6	53.50
22SFSCW441	22 qt.	6	67.50
Allergen-Free CamSquare Seal Covers			
SFC2SCPP441	Fits 2 & 4 qt.	6	4.70
SFC6SCPP441	Fits 6 & 8 qt.	6	5.95
SFC12SCPP441	Fits 12, 18 & 22 qt.	6	8.60
Allergen-Free Trays			
1418	13 ¹⁵ / ₁₆ " x 17 ¹⁵ / ₁₆ "	12	27.70
Allergen-Free Measuring Cups			
25MCCW441	1 Cup (dry measure)	12	8.90
50MCCW441	1 pt.	12	16.55
100MCCW441	1 qt.	12	18.55
200MCCW441	2 qt.	12	25.60
400MCCW441	4 qt.	1	28.20

Color: Allergen-Free Purple (441).





LIDO AND CAMWEAR® TUMBLERS

Lido® Tumblers

- Easy to clean internal stacking ring promotes stable and space-efficient storage.
- Made of impact resistant SAN plastic that resists chips and breaks, minimizing replacement costs.

Color: Clear (152).
Lid Color: Translucent (190).

Capacity is to the top fill-line.

Lido Tumblers are covered by U.S. Patent D720,963 S.



*6 oz. and 9 oz. tumblers feature subtle graduation markings intended for use in healthcare operations to measure liquid intake.



CODE	LDT5	LDT6	LDT9	LDT10	LDT12	LDT16	LDT22
FITS LID	CLJ6	CLST6	CL900P	CLNT10	CLNT12	CLST9	CLSM8B5**
DIAMETER	2 ⁵ / ₁₆ "	2 ¹¹ / ₁₆ "	3 ³ / ₁₆ "	2 ⁷ / ₈ "	3"	3 ⁵ / ₁₆ "	3 ¹ / ₂ "
HEIGHT	3 ¹¹ / ₁₆ "	3 ¹¹ / ₁₆ "	3 ¹¹ / ₁₆ "	4 ¹ / ₂ "	4 ¹⁵ / ₁₆ "	5 ⁵ / ₁₆ "	6 ⁵ / ₈ "
FULL SIZE CAMRACK®	49S318	36S318	25S318	36S418	30S434	25S534	20S638
CAPACITY TO RIM	5 oz.	6 oz.*	9 oz.*	10 oz.	12 oz.	16 oz.	22 oz.
CASE PACK TUMBLER / LID	36 / 1,000	36 / 1,000	36 / 1,000	36 / 1,000	36 / 1,000	36 / 1,000	36 / 1,500
TUMBLER LIST PRICE EACH	\$ 2.11	\$ 2.32	\$ 2.65	\$ 2.65	\$ 2.70	\$ 3.30	\$ 4.05
LID PRICE PER CASE	\$ 80.50	\$ 84.25	\$ 118.25	\$ 107.75	\$ 118.25	\$ 118.25	\$ 118.25

**Excludes a cross-slot for straws.

Camwear Tumblers

- The look and feel of glass but made of durable Camwear.
- Textured exterior surface resists scratching.
- Smooth interior promotes easy cleaning.
- Designed with a Sani-Rim lip for sanitary drinking.

Color: Clear (152).

Capacities calculated to rim.

Withstands temperatures from -40° to 210°F.



CODE	500CW	800CW	850CW	950CW	1200CW	1600CW
FITS LID	—	—	—	CLNT10	—	CL900P
MAX DIAMETER	2 ¹ / ₄ "	2 ⁵ / ₈ "	3 ³ / ₈ "	2 ³ / ₄ "	2 ¹⁵ / ₁₆ "	3 ³ / ₈ "
MAX HEIGHT	3 ³ / ₈ "	3 ⁷ / ₈ "	3 ¹³ / ₁₆ "	4 ³ / ₈ "	5 ³ / ₁₆ "	5 ¹ / ₄ "
FULL SIZE CAMRACK®	49S318	36S418	25S418	36S418	25S434	25S534
CAPACITY TO RIM	5.4 oz.	8 oz.	9.1 oz. (Heavy wall)	9.6 oz.	13 oz.	17 oz.
CASE PACK TUMBLER / LID	48 / —	48 / —	48 / —	48 / 1,000	48 / —	48 / 1,000
TUMBLER LIST PRICE EACH	\$ 1.88	\$ 2.37	\$ 6.00	\$ 2.70	\$ 3.15	\$ 3.90
LID PRICE PER CASE	—	—	—	\$ 107.75	—	\$ 118.25

CAMWEAR® HUNTINGTON® AND NEWPORT TUMBLERS

Huntington Tumblers

- Feature the elegant look and feel of glass without the high replacement costs.
- Made of durable Camwear.
- Lightweight.
- Stacking lugs to prevent sticking.
- Three sided drain bottom for easy washing and drying.

Colors: Azure Blue (196), Clear (135).
Lid Color: Translucent (190).

Capacities calculated to rim.

Withstands temperatures from
-40° to 210°F.

*Excludes a cross-slot for straws.



CODE	HT5CW	HT8CW	HT10CW	HT120CW	HT12CW	HT14CW	HT16CW	HT22CW
FITS LID	—	CLNT8	—	CLNT12	—	—	CLAM8B5*	CLSM8B5*
MAX DIAMETER	2 ¹ / ₃₂ "	2 ¹ / ₁₆ "	2 ³ / ₁₆ "	3"	3 ³ / ₈ "	3 ¹ / ₄ "	3 ³ / ₁₆ "	3 ¹ / ₂ "
MAX HEIGHT	3 ³ / ₁₆ "	4 ⁷ / ₁₆ "	4 ¹³ / ₁₆ "	5"	3 ³ / ₄ "	4 ⁷ / ₈ "	5 ¹ / ₂ "	6 ¹¹ / ₁₆ "
FULL SIZE CAMRACK®	49S434	36S418	36S434	25S434	25S418	25S434	25S534	25S638
CAPACITY TO RIM	5 oz.	8 oz.	10 oz.	12 oz.	12 oz.	14 oz.	16 oz.	22 oz.
CASE PACK TUMBLER / LID	36 / —	36 / 1,000	36 / —	36 / 1,000	36 / —	36 / —	36 / 2,000	36 / 1,500
TUMBLER LIST PRICE EACH	\$ 3.20	\$ 3.35	\$ 3.90	\$ 4.05	\$ 3.50	\$ 4.05	\$ 5.00	\$ 6.45
LID PRICE PER CASE	—	\$ 84.25	—	\$ 118.25	—	—	\$ 119.50	\$ 118.25

InStock Color: Clear (135).

Newport Tumblers

- Fluted design features the upscale look of glass with the safety benefits and cost savings of plastic.
- Impact resistant SAN plastic resists chips and breaks.
- Stacking lugs prevent sticking.
- Sani-Rim lip provides a sanitary drinking surface.

Colors: Clear (152), Amber (153),
Slate Blue (401).

Lid Color: Translucent (190).

Capacities calculated to rim.

Withstands temperatures from
-4° to 185°F.

*Excludes a cross-slot for straws.



CODE	NT5	NT8	NT9	NT10	NT12	NT14	NT16	NT20
FITS LID	CLNT5	CLNT8	CLNT9	CLNT10	CLNT12	—	—	CLSM8B5*
MAX DIAMETER	2 ¹ / ₂ "	2 ¹¹ / ₁₆ "	3 ¹ / ₄ "	2 ¹³ / ₁₆ "	3"	3 ³ / ₈ "	3 ¹ / ₄ "	3 ³ / ₁₆ "
MAX HEIGHT	3 ¹ / ₁₆ "	4"	3 ³ / ₁₆ "	4 ³ / ₁₆ "	5 ¹ / ₈ "	5"	5 ³ / ₄ "	6 ¹ / ₂ "
FULL SIZE CAMRACK	36S318	36S418	25S318	36S434	25S434	25S434	25S534	25S638
CAPACITY TO RIM	6.4 oz.	8 oz.	9.3 oz.	10 oz.	12.6 oz.	14 oz.	16.4 oz.	22 oz.
CASE PACK TUMBLER / LID	36 / 1,500	36 / 1,000	36 / 1,000	36 / 1,000	36 / 1,000	36 / —	36 / —	36 / 2,000
TUMBLER LIST PRICE EACH	\$ 1.90	\$ 1.95	\$ 2.16	\$ 2.37	\$ 2.48	\$ 2.85	\$ 3.00	\$ 3.60
LID PRICE PER CASE	\$ 124.00	\$ 84.25	\$ 118.25	\$ 107.75	\$ 118.25	—	—	\$ 118.25

InStock Color: Clear (152).

LAGUNA® AND DEL MAR® TUMBLERS

Laguna Tumblers

- Hammered texture hides water spots and scratches.
- Made of impact resistant SAN.
- Lightweight and easy to carry.

Colors: Clear (152), Spanish Green (427).

Lid Color: Translucent (190).

Capacities calculated to rim.

Withstands temperatures from -4° to 185°F.

*Excludes a cross-slot for straws.



CODE	LT6	LT8	LT10	LT12	LT14	LT16	LT22
FITS LID	CLLT6	CLLT8	CLLT10	CLLT12	—	CLAM8B5*	—
MAX DIAMETER	2½"	2¾"	2⅝"	3⅝"	3¼"	3⅜"	3⅞"
MAX HEIGHT	4¼"	4¼"	4¾"	5"	5⅝"	5½"	6⅞"
FULL SIZE CAMRACK®	36S418	36S418	30S434	30S434	25S434	25S534	16S534
CAPACITY TO RIM	6 oz.	8 oz.	10 oz.	12 oz.	14 oz.	16 oz.	22 oz.
CASE PACK TUMBLER / LID	36 / 1,500	36 / 2,000	36 / 1,000	36 / 1,000	36 / —	36 / 2,000	36 / —
TUMBLER LIST PRICE EACH	\$ 2.43	\$ 2.60	\$ 2.70	\$ 3.00	\$ 3.20	\$ 3.50	\$ 4.00
LID PRICE PER CASE	\$ 132.25	\$ 172.00	\$ 107.75	\$ 118.25	—	\$ 119.50	—

InStock Color: Clear (152).

Del Mar Tumblers

- Crackled glass look features the lightweight handling of plastic.
- Thick sturdy base and rolled rim edge for added stability.
- Made of impact resistant SAN plastic.

Colors: Clear (152), Ruby Red (156), Sapphire Blue (608), Light Amber (609).

Lid Color: Translucent (190).

Capacities calculated to rim.

Del Mar Tumblers are covered by the following U.S. Patent D 478,778 S.

Withstands temperatures from -4° to 185°F.



CODE	D8	D12	D14	D16	D24
FITS LID	—	—	CLST9	—	—
MAX DIAMETER	2⅝"	2⅝"	3¼"	3⅜"	3⅞"
MAX HEIGHT	4⅜"	4¾"	4⅝"	5⅝"	6⅝"
FULL SIZE CAMRACK	36S418	25S434	25S418	25S534	25S638
CAPACITY TO RIM	8 oz.	12 oz.	14 oz.	16 oz.	24 oz.
CASE PACK TUMBLER / LID	36 / —	36 / —	36 / 1,000	36 / —	36 / —
TUMBLER LIST PRICE EACH	\$ 1.85	\$ 1.95	\$ 2.48	\$ 2.55	\$ 3.30
LID PRICE PER CASE	—	—	\$ 118.25	—	—

InStock Color: Clear (152).

COLORWARE TUMBLERS

- A classic value tumbler ideal for casual dining.
- Textured on the outside to resist scratching.
- Made of impact resistant SAN.
- Interior stacking lugs for easy storing.
- Sani-Rim lip provides a sanitary drinking surface.

Colors: Slate Blue (401), Clear (152), Amber (153), Ruby Red (156).
Lid Color: Translucent (190).

Capacities calculated to rim.

Withstands temperatures from -4° to 185°F.



CODE (72 PACK)	500P	800P	900P	950P	1200P	1600P	2000P	—
CODE (24 PACK)	500P2	800P2	900P2	950P2	1200P2	1600P2	2000P2	3200P2
FITS LID	CLJ6	CL800P	CL900P	CL950P	—	—	—	—
MAX DIAMETER	2¼"	2½"	3⅜"	2¾"	2½"	3⅜"	3⅝"	3⅜"
MAX HEIGHT	3½"	4"	3¼"	4⅜"	5⅜"	5¼"	6½"	7¼"
FULL SIZE CAMRACK	49S318	36S418	25S318	36S418	25S434	25S534	25S638	16S738
CAPACITY TO RIM	5.2 oz.	7.8 oz.	9.7 oz.	9.8 oz.	12.6 oz.	16.4 oz.	22 oz.	32 oz.
P CODE-CASE PACK	72	72	72	72	72	72	72	—
P2 CODE-CASE PACK	24	24	24	24	24	24	24	24
LID CASE PACK	1,000	1,000	1,000	1,000	—	—	—	—
TUMBLER LIST PRICE EACH - 72 PACK	\$ 1.32	\$ 1.53	\$ 2.60	\$ 1.74	\$ 1.95	\$ 2.37	\$ 2.95	—
TUMBLER LIST PRICE EACH - 24 PACK	\$ 1.37	\$ 1.64	\$ 2.85	\$ 1.90	\$ 2.11	\$ 2.48	\$ 3.20	\$ 4.70
LID PRICE PER CASE	\$ 80.50	\$ 92.50	\$ 118.25	\$ 86.25	—	—	—	—

InStock Color: Clear (152).

Coca-Cola® Tumblers

- Colorware Tumblers featuring the Coca-Cola trademark logo in White.
- Available only to Coca-Cola fountain customers for foodservice use.

Color: Clear (152).

Coca-Cola Logo is imprinted in White only.

These trademarked tumblers may not be resold at retail and are available only for distribution to Coca-Cola Fountain customers for food service use.

Withstands temperatures from -4° to 185°F.



CODE	20CC	32CC
MAX DIAMETER	3⅜"	3⅜"
MAX HEIGHT	6½"	7¼"
FULL SIZE CAMRACK	25S638	16S738
CAPACITY TO RIM	22 oz.	32 oz.
CASE PACK	72	24
LIST PRICE EACH - 72 PACK	\$ 3.40	—
LIST PRICE EACH - 24 PACK	—	\$ 5.20

Camrack® IceExpress Glass Filler

- Dramatically reduces banquet set-up time.
- Fills 25 glasses with ice all at once.
- Reduces breakage and risk of contamination.
- Ice falls directly into glasses with no spills or drips.



CODE	EXTERIOR DIMENSIONS W x D x H	LIST PRICE EA.
25SWGf	20" x 20⅞" x 1¼"	\$ 120.50

Case Pack: 1 Color: Black (110).

Dessert Glass

- Large, heavy bases for stability.
- Bases designed for fast draining and complete drying.
- Chill or frost barware without concerns of thermal shock damage.



Color: Clear (135).



CODE	DG3CW*
MAX DIAMETER	2⅞"
MAX HEIGHT	3"
FULL SIZE CAMRACK®	49S318
CAPACITY TO RIM	3.4 oz.
CASE PACK	72
LIST PRICE EACH	\$ 2.95

Color/InStock Color: Clear (135).

* Cases only. No broken cartons.

CAMWEAR® CAMLITER BEVERAGE DECANTERS

Camwear Camliter Beverage Decanters

- Ideal for serving beverages at restaurants, buffets, and outdoor events
- Spill-proof, snap tight flat lids included to protect content from cross contamination
- Flip lid design to seal beverages and make it easy to pour
- Pour spout lid available to protect content while allowing free pour
- Light weight; dent, impact, and scratch resistant material.
- NSF Listed (bottles only; lids not listed)

Color: Clear (135).
Lid Color: White (148).
Flip Lid Color: White (190).

Personalize with a logo to promote your brand. For information please refer to the Table Service Personalization page.



WW1000L - Flat Lid

WW1000LS - Pour Spout

WW1000LT - Flip Lid®

CODE	CAPACITY	HEIGHT	LIST PRICE EA.
Camliters with Flat Lids			
WW1500	1½ L	10"	\$ 16.45
WW1000	1	9¾"	14.65
WW750	New! ¾	8¾"	12.25
WW500	½	7⅞"	9.35
WW250	¼	6¼"	5.65
Camliters with Flip Lids			
WW1000T	New! 1	9⅛"	13.80
WW750T	New! ¾	8¾"	13.15
Lids			
WW1000LS (Pour spout lid for 1½ L, 1L, ¾L and ½ L)			1.16
WW1000L (Replacement lid for 1½ L, 1L, ¾L and ½ L)			1.16
WW1000LT (Flip lid for WW750T and WW1000T)			2.25
WW250L (Replacement lid for ¼ L)			1.16

Case Pack: 12 InStock Color: Clear (135) or White (190) for Flip Lid.

CAMWEAR® PITCHERS

- Lightweight for easy handling.
- Exclusive ice-control contoured lip and pour spout reduce spills.
- Slotted base allows for complete and sanitary drying.

Color: Clear (135). P600CW is also available in Amber (153).

InStock Color: Clear (135).

Capacities calculated to rim.

PC34CW Stackable Pitcher is covered by the following U.S. Patent D 682,002 S.



P320CW, P480CW and P600CW

An industry standard. Broad base for stability, prevents tipping.



P320CW

CAPACITY: 32 oz.
HEIGHT WITH SPOUT: 6¾"
DIAMETER WITH HANDLE: 5¾"
LIST PRICE EACH: \$ 13.20
Case Pack: 6



P480CW

CAPACITY: 48 oz.
HEIGHT WITH SPOUT: 7⅞"
DIAMETER WITH HANDLE: 6¼"
LIST PRICE EACH: \$ 15.95
Case Pack: 6



P600CW

CAPACITY: 60 oz.
HEIGHT WITH SPOUT: 8"
DIAMETER WITH HANDLE: 6¾"
LIST PRICE EACH: \$ 17.35
Case Pack: 6



P60CW

CAPACITY: 60 oz.
HEIGHT WITH SPOUT: 9"
DIAMETER WITH HANDLE: 7¼"
LIST PRICE EACH: \$ 19.45
Case Pack: 6

PL60CW

Laguna® pitcher with hammered texture that hides scratches. Pour liquids from front or ice and liquid from sides. Matching tumblers available.



PL60CW

CAPACITY: 60 oz.
HEIGHT WITH SPOUT: 7⅞"
DIAMETER WITH HANDLE: 6¾"
LIST PRICE EACH: \$ 11.60
Case Pack: 6

PE600CW

Economy and lightweight design. Pour liquids from front or ice and liquid from sides.



PE600CW

CAPACITY: 60 oz.
HEIGHT WITH SPOUT: 7⅞"
DIAMETER WITH HANDLE: 7⅝"
LIST PRICE EACH: \$ 11.60
Case Pack: 6

P64CW

Tapered design and drip-proof spout.



P64CW

CAPACITY: 64 oz.
HEIGHT WITH SPOUT: 9¼"
DIAMETER WITH HANDLE: 7⅞"
LIST PRICE EACH: \$ 19.45
Case Pack: 6

PC64CW

Three position lid can strain ice, free pour or close to protect contents.



PC64CW

CAPACITY: 64 oz.
HEIGHT WITH SPOUT: 9¼" with lid
DIAMETER WITH HANDLE: 7⅞"
LIST PRICE EACH: \$ 24.95
Case Pack: 6

PC34CW

Stackable pitchers and lid with frosted design to hide scratches.



PC34CW

CAPACITY: 34 oz.
HEIGHT WITH SPOUT: 7½" with lid
DIAMETER WITH HANDLE: 6⅝"
LIST PRICE EACH: \$ 11.75
Case Pack: 6

CAMWEAR® DINNERWARE

5 5 YEAR PRORATED WARRANTY
AGAINST BREAKAGE

- Durable Camwear resists stains, odors and scratches.
- Textured surface on salad and dinner plates for long wear.
- Ideal for schools, cafeterias, day care centers and healthcare facilities.
- Mug and stacking cup can be personalized.

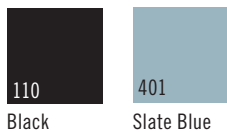
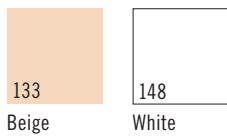

Oval Platters and Compartment Plates



CODE	90SPCW	120CWP	93CW	HK93BCW*
DIAMETER	9" x 1 $\frac{1}{16}$ "	12" x 9"	9"	9 $\frac{1}{2}$ "
DESCRIPTION	Round, soup bowl	Oval, narrow rim	Narrow rim	Heat Keeper base
CASE PACK	48	24	48	12
LIST PRICE EACH	\$ 9.05	\$ 10.40	\$ 9.00	\$ 19.35

*HK93BCW is available in Beige (133) only.

Plates



CODE	10CWNR	9CWNR	825CWNR	725CWNR	65CWNR	55CWNR
DIAMETER	10"	9"	8 $\frac{1}{4}$ "	7 $\frac{1}{4}$ "	6 $\frac{5}{16}$ "	5 $\frac{1}{2}$ "
DESCRIPTION	Narrow rim	Narrow rim	Narrow rim	Narrow rim	Narrow rim	Narrow rim
CASE PACK	48	48	48	48	48	48
LIST PRICE EACH	\$ 8.50	\$ 6.15	\$ 6.40	\$ 5.55	\$ 4.05	\$ 3.40

Bowls



CODE	10CW	10CWL	35CW	45CW	50CW	60CW	100CW	150CW
APPROX. CAPACITY	9.4 oz.	—	8.4 oz.	5 oz.	15.3 oz.	10.9 oz.	12.5 oz.	16.7 oz.
DESCRIPTION	Square bowl	Lid for 10CW bowl	Bouillon	#3 $\frac{1}{2}$ Fruit cup	Nappie bowl	#1 Grapefruit bowl	5" Nappie	Square bowl
CASE PACK	48	48	48	48	48	48	48	48
SHAPE	Square	Square	Round	Round	Round	Round	Round	Top/Rnd-Bottom/Sqr
OUTSIDE DIA.	Top: 4" x 4"	—	3 $\frac{15}{16}$ "	4 $\frac{5}{8}$ "	5 $\frac{1}{4}$ "	6"	5"	Top: 5 $\frac{1}{4}$ "
HEIGHT	1 $\frac{1}{8}$ "	$\frac{7}{8}$ "	2 $\frac{1}{8}$ "	1 $\frac{1}{16}$ "	2 $\frac{1}{8}$ "	1 $\frac{1}{2}$ "	1 $\frac{11}{16}$ "	2 $\frac{3}{8}$ "
LIST PRICE EACH	\$ 4.05	\$ 3.15	\$ 2.75	\$ 3.40	\$ 4.05	\$ 4.05	\$ 3.45	\$ 5.55

Mugs and Cups



CODE	75CW	96CW
APPROX. CAPACITY	7.5 oz.	9.6 oz.
DESCRIPTION	Stacking cup	Mug
CASE PACK	48	48
MAX DIA. / HEIGHT	4 $\frac{1}{16}$ " - 3 $\frac{3}{16}$ "	4 $\frac{1}{16}$ " - 3 $\frac{3}{4}$ "
FULL SIZE CAMRACK®	16C414	16C414
LIST PRICE EACH	\$ 5.30	\$ 5.30

Maximum diameter includes handle.

Camwear® Heat Keepers



CODE	HK93CW	HK39
DESCRIPTION	3 Compartment base and cover	Heat keeper base and cover for 9" plate
CASE PACK	6	6
LIST PRICE EACH	\$ 35.65	\$ 36.90

HK93CW is available in Beige (133). HK39 is available in Antique White (148).

VERSA CAMCOVERS®

Serve hot food hot with the Versa Camcover, an elegant and efficient alternative to traditional metal covers.

- Microwave safe plate covers withstands temperatures up to 300°F (149°C)*.
- Covers remain cool to the touch for easy handling.
- Lighter and quieter than metal covers.
- Elegant appearance without polishing.
- Keeps food warm longer than metal covers.

- Available in a variety of sizes in round and square.
- Made of fiberglass material.

Colors: Granite Gray (191), Antique Parchment (101).

*Can be used in heated carts.

For help selecting the correct size plate cover, refer to the Camcover Sizing Guide on our website at www.cambro.com. Or, send one of your plates to Cambro Customer Service for sizing.

Microwave safe.



CODE	INSIDE DIAMETER	OUTSIDE HEIGHT	LIST PRICE EA.
Square			
85SFVS	8 ⁵ / ₈ "	2 ³ / ₄ "	\$ 18.60
978SFVS	10"	2 ³ / ₄ "	18.95
Round			
68VS	6 ¹ / ₂ "	2 ³ / ₁₆ "	15.75
86VS	8 ¹ / ₄ "	2 ⁵ / ₈ "	17.45
91VS	9 ¹ / ₈ "	2 ¹¹ / ₁₆ "	18.60
913VS	9 ¹³ / ₁₆ "	2 ¹¹ / ₁₆ "	18.60
95VS	9 ⁵ / ₁₆ "	2 ¹¹ / ₁₆ "	18.60
99VS	9 ⁹ / ₁₆ "	2 ⁵ / ₈ "	18.60
911VS	9 ¹¹ / ₁₆ "	2 ³ / ₄ "	19.20
100VS	10"	2 ¹¹ / ₁₆ "	18.95
103VS	10 ¹ / ₁₆ "	2 ¹¹ / ₁₆ "	19.50
105VS	10 ³ / ₁₆ "	2 ¹¹ / ₁₆ "	19.50
106VS	10 ¹³ / ₃₂ "	2 ¹³ / ₁₆ "	21.90
1010VS	10 ⁵ / ₈ "	2 ¹¹ / ₁₆ "	20.70
1012VS	10 ³ / ₄ "	2 ¹¹ / ₁₆ "	20.70
1014VS	10 ⁷ / ₈ "	2 ¹¹ / ₁₆ "	20.70
116VS	11 ³ / ₈ "	3 ³ / ₁₆ "	22.30
120VS	12"	2 ⁷ / ₈ "	28.60
124VS	12 ¹ / ₄ "	2 ⁷ / ₈ "	29.60

Case Pack: 12



CAMWEAR® CAMCOVERS

- Food stays hot and appetizing without re-heating.
- Ideal for use in heated carts up to 210°F (99°C)*.
- Made of durable Camwear, will not dent or scratch.
- Lightweight for quiet service.
- Saves on labor with no polishing required.

Colors: Clear (152), Amber (153), Beige (133), Silver (486).

MDCPC9CW Colors: Clear (135), Amber (153), Beige (133), Silver (486).

For help selecting the correct size plate cover, refer to the Camcover Sizing Guide on our website at www.cambro.com. Or, send one of your plates to Cambro Customer Service for sizing.



CODE	INSIDE DIAMETER	OUTSIDE HEIGHT	LIST PRICE EA.
Camwear Camcovers			
806CW	8 ⁷ / ₁₆ "	2 ¹¹ / ₁₆ "	\$ 12.05
900CW	9 ¹ / ₈ "	2 ³ / ₄ "	12.15
901CW	9 ⁹ / ₁₆ "	2 ¹³ / ₁₆ "	13.00
905CW	9 ¹ / ₂ "	2 ¹³ / ₁₆ "	13.30
909CW	9 ³ / ₄ "	2 ³ / ₄ "	13.25
9011CW	10"	2 ⁷ / ₈ "	14.50
9013CW	10"	2 ³ / ₄ "	14.50
1000CW	10 ³ / ₁₆ "	2 ¹¹ / ₁₆ "	14.45
1005CW	10 ⁹ / ₁₆ "	2 ¹³ / ₁₆ "	14.70
1007CW	10 ⁷ / ₈ "	2 ³ / ₄ "	14.70
1013CW	10 ¹³ / ₁₆ "	2 ¹¹ / ₁₆ "	14.75
1101CW	11"	2 ¹¹ / ₁₆ "	14.70
1202CW	12 ¹ / ₈ "	2 ³ / ₄ "	14.75
Camwear Low Profile Camcover			
MDCPC9CW	9 ¹ / ₈ "	2"	10.75

Case Pack: 12

BEVERAGE DISPENSER, PAIL WITH BAIL AND SWIRL BOWLS®

6-Gallon Beverage Dispenser

- Perfect for mixing and serving concentrated beverages.
- Standard and metric graduations are printed on dispenser.
- Impact resistant polyethylene withstands temperatures from -40° to 160°F (-40° to 70°C).

CODE	LIST PRICE EA.
DSPR6	\$ 61.00
Case Pack: 1 Color: White (148).	
DSPR6 Capacity: 6 gallons (22,7 L).	



Pail with Bail – Poly

- A large, multi-purpose, 22 quart (20,8 L) pail, ideal for mixing, storing and transporting.
- Durable polyethylene withstands temperatures from -40° to 160°F (-40° to 70°C), and is stain resistant.
- Snap-tight, thumb tab cover sold separately.

CODE	LIST PRICE EA.
PWB22	\$ 35.75
RFSC12 (cover)	6.60
Case Pack: 6 Color: White (148).	
All graduations are approximate.	



Swirl Bowls

- Ideal for hot or cold side dishes, desserts, dips, or fruit.
- Fits on a plate or stacks in place on a buffet station.
- Available in durable Camwear® or break resistant SAN.

Colors:
SRB5CW and SRB13CW: Clear (135), Black (110), White (148).
SRB5 and SRB13: Clear (152), Black (110), White (148).

*Made of (P.E.T.) material.



Disposable lid available

SRB13CW

SRB5CW

CODE	CAPACITY	CASE PACK	LIST PRICE EA.
Camwear			
SRB5CW	5 oz.	24	\$ 2.75
SRB13CW	13	24	5.55
SAN			
SRB5	5	24	2.37
SRB13	13	24	4.40
Disposable Lid			
CLSRB5*	Fits 5 oz. only	1,000	177.00

Disposable Lid Color: Clear (152). **InStock Colors:** Clear (152).

CAMWEAR® WINE BUCKETS AND BUD VASE

Wine Buckets

- Chill and showcase wine or champagne.
- Tough Camwear won't crack or break and is easy to clean.

Color: Clear (135).



WC100CW

CODE	SIZE DIA. x H	LIST PRICE EA.
WC100CW	8" x 9 $\frac{1}{8}$ "	\$ 53.75
WC100CWNH (without handles)	8" x 9"	30.90

Case Pack: 1

Bud Vase

- Ideal for dining rooms, cafeteria tables and patient or room service trays.
- Made of durable Camwear.
- Fill with a fresh rose bud or a colorful faux flower.

Colors: Black (110), Clear (135), White (148).



CODE	DESCRIPTION	LIST PRICE EA.
BV6CW	6" Bud vase	\$ 4.30

Case Pack: 12

PROMOTE YOUR BRAND – PERSONALIZED TABLE SERVICE AND FOOD STORAGE PRODUCTS

Personalize tumblers, barware, pitchers, decanters and dinnerware to promote a brand, business or enhance customer satisfaction. Use to identify inventory for multiple service locations. Personalize food storage products to identify contents, add fill lines with recipe instructions to ensure product quality and consistency. Personalized product orders are full case quantities only, no broken cartons.



Look for this icon that identifies items that can be personalized.



PAD PRINT PERSONALIZATION

- One color. Two color available for table service products only.
- Choose from 12 standard imprint colors.
- Print area is 1/4" – 4", based on printable area specific to product. Order minimum 72 each.

PERSONALIZATION CHARGES

- Custom Personalization Plate Charge.
- \$75.00 Net (one-time charge, billed on first purchase order).
- Set Up Charge \$50.00 Net per order.
- Color Imprint Charge \$.30 Net per side, per color.

HOW TO ORDER A SAMPLE

- 1. Request a Sample**
Contact your local Cambro representative to complete and submit your sample request to Cambro. Form **MUST BE** submitted with artwork.
- 2. Artwork**
Must be ready to use, digital format only. Email to Cambro Representative or to Cambro at letsgetpersonal@Cambro.com. Title email subject with logo name. Provide contact info. If artwork is incomplete, graphic services are available for \$50.00 per hour.
File Dimensions: 100% reproduction size, 300 dpi resolution
File Type: Adobe® Illustrator®, Photoshop®
File Format: jpeg, tiff, eps.
- 3. Sample Turnaround**
7 – 10 business days from approval of artwork.
- 4. Sample Approval**
Signed approval form must be included with purchase order for processing. This form is included with each sample.
- 5. Sample Charge (net)**
\$50.00 per sample (charge billed on sample order, credited back on first purchase order).
- 6. Questions?**
Contact our Personalization Team at 800-854-7631 Ext. 4125 or email letsgetpersonal@Cambro.com.

CHOOSE ONE OR TWO STANDARD IMPRINT COLORS



Due to the catalog printing process, the colors shown may not be exact.

DELI CROCKS & PLATTER

- Prep, store and serve all in one with contemporary style at an economical price.
- Crock and platter are made of SAN, making them impact, stain and chip resistant.
- Ideal for supermarket delis, sandwich shops, buffets and catered events.
- Handled covers are made of crystal clear, virtually unbreakable Camwear®.

Crock and Platter Colors: Clear (152), Black (110), White (148), Red (404).

Crock Cover Color: Clear (135).

Deli Crock covers are covered by the following U.S. Patents D 504,283 S, D 503,871 S & D 494,419 S. Scalloped Food Service Cover is covered by the following U.S. Patent D 509,705 S.

DCC5, DCC10 are NSF Component.



Prep, stack, store and serve all in one.



Interstacking saves storage space.



Avoid cross contamination and keep food fresh by using clear cover with handle.



Lid can be used as a riser to provide additional height on the buffet table or in a deli display case.



Cover doubles as a false bottom for presentation and to reduce waste.

Crocks & Platter



CODE	DC5	DC10	DP15
DESCRIPTION	Crock	Crock	Platter
DIMENSIONS L x D x H	10 ⁵ / ₁₆ " x 6 ¹³ / ₁₆ " x 3 ³ / ₁₆ "	13 ³ / ₁₆ " x 10 ⁷ / ₁₆ " x 3 ³ / ₁₆ "	15 ³ / ₄ " x 11 ⁵ / ₁₆ " x 2 ³ / ₁₆ "
APPROX. CAPACITY	2.2 qt.	4.9 qt.	3.4 qt.
LIST PRICE EACH	\$ 13.45	\$ 18.40	\$ 15.75

Case Pack: 6

Covers

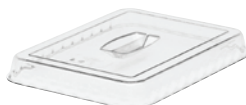

CODE	DCC5 fits DC5	DCC10 fits DC10
DIMENSIONS L x D x H	9 ³ / ₈ " x 5 ⁷ / ₈ " x 1 ¹ / ₁₆ "	12 ³ / ₁₆ " x 9 ⁷ / ₁₆ " x 1 ¹ / ₁₆ "
APPROX. CAPACITY	0.9 qt.	2 qt.
LIST PRICE EACH	\$ 9.40	\$ 13.10

Case Pack: 6



CAMWEAR® BOWLS

Round Pebbled Bowls

- Textured on the outside for an elegant look, smooth on the inside for easy cleaning.
- Made of virtually unbreakable Camwear for years of dependable service.
- Ideal for fruit, salads, snacks and desserts.

Color: Pebbled (176).

Capacities are calculated to rim.



Ribbed Bowls

- Stylish, contemporary appearance for a dramatic presentation.
- Made of virtually unbreakable Camwear that won't break like glass.
- Bowls are durable and lightweight. Will not chip and crack like acrylic.
- Resistant to stains, acids and odors.

Colors: Clear (135), Black (110), White (148).

Rectangular Ribbed Bowls are not available in White (148).

Capacities are calculated to rim.



Round Pebbled Bowls



CODE	PSB6	PSB8	PSB10	PSB12
INSIDE DIAMETER	6"	8"	10"	12"
OUTSIDE DIAMETER x HEIGHT	6 ¹³ / ₁₆ " x 1 ¹ / ₂ "	8 ¹³ / ₁₆ " x 2 ¹¹ / ₁₆ "	10 ¹³ / ₁₆ " x 3 ¹ / ₄ "	12 ¹³ / ₁₆ " x 4"
APPROX. CAPACITY	18.8 oz.	1.6 qt.	3.2 qt.	5.8 qt.
CASE PACK	12	12	12	12
LIST PRICE EACH	\$ 4.40	\$ 7.55	\$ 14.85	\$ 19.30

InStock Color: Pebbled (176).

CAMWEAR® BOWLS

Round Pebbled Bowls



CODE	PSB15	PSB18	PSB23
INSIDE DIAMETER	15"	18"	23"
OUTSIDE DIAMETER x HEIGHT	15 ³ / ₄ " x 4 ⁷ / ₈ "	18 ³ / ₄ " x 5 ³ / ₄ "	23 ³ / ₄ " x 7 ⁷ / ₁₆ "
APPROX. CAPACITY	11.2 qt.	20.2 qt.	40 qt.
CASE PACK	4	4	4
LIST PRICE EACH	\$ 31.35	\$ 49.95	\$ 76.25

InStock Color: Pebbled (176).

Rectangular Ribbed Bowls



CODE	RSB912CW	RSB1014CW	RSB1419CW
DIMENSIONS L x D x H	12 ¹ / ₈ " x 9" x 3"	14 ⁹ / ₁₆ " x 10 ¹³ / ₁₆ " x 3 ⁹ / ₁₆ "	19 ³ / ₁₈ " x 14 ³ / ₁₈ " x 4 ¹¹ / ₁₆ "
APPROX. CAPACITY	2.9 qt.	5 qt.	12 qt.
CASE PACK	12	4	4
LIST PRICE EACH	\$ 15.60	\$ 22.80	\$ 37.00

Rectangular Ribbed Bowls are not available in White (148).

Round Ribbed Bowls



CODE	RSB6CW	RSB8CW	RSB10CW	RSB12CW
INSIDE DIAMETER	6"	8"	10"	12"
OUTSIDE DIAMETER x HEIGHT	6 ¹³ / ₁₆ " x 1 ¹ / ₂ "	8 ¹³ / ₁₆ " x 2 ¹¹ / ₁₆ "	10 ¹³ / ₁₆ " x 3 ¹ / ₄ "	12 ¹³ / ₁₆ " x 4"
APPROX. CAPACITY	18.8 oz.	1.65 qt.	3.2 qt.	5.8 qt.
CASE PACK	12	12	12	12
LIST PRICE EACH	\$ 5.65	\$ 10.90	\$ 19.95	\$ 33.25



CODE	RSB15CW	RSB18CW	RSB23CW
INSIDE DIAMETER	15"	18"	22 ⁷ / ₈ "
OUTSIDE DIAMETER x HEIGHT	15 ³ / ₄ " x 4 ¹⁵ / ₁₆ "	18 ³ / ₄ " x 5 ¹³ / ₁₆ "	23 ³ / ₄ " x 7 ⁷ / ₁₆ "
APPROX. CAPACITY	11.2 qt.	20.2 qt.	40 qt.
CASE PACK	4	4	4
LIST PRICE EACH	\$ 43.00	\$ 62.00	\$ 93.25

InStock Color: Black (110).

BUDGET & FIBERGLASS BOWLS

Budget Salad Bowls

- An economical serving choice for fruit, salads, snacks and desserts.
- Impact resistant FDA approved material resists stains, acids and odors.

Colors: Birch (174), Black (110).

Capacities are calculated to rim.



CODE	SB55	SB60	SB80
INSIDE DIAMETER	5 ¹ / ₁₆ "	6"	8"
OUTSIDE DIAMETER x HEIGHT	5 ¹ / ₁₆ " x 1 ⁹ / ₁₆ "	6" x 1 ⁹ / ₁₆ "	8" x 2 ⁵ / ₁₆ "
APPROX. CAPACITY	10.9 oz.	12.6 oz.	31.2 oz.
LIST PRICE EACH	\$ 2.37	\$ 2.85	\$ 5.85

Case Pack: 72

Fiberglass Bowls

- Combines the look of warm wood grains with the durability of fiberglass.
- Colors won't fade even after years of service and washing.

Color: Dark Basketweave (301).

Capacities are calculated to rim.



CODE	6F	8F
INSIDE DIAMETER	6 ⁷ / ₈ "	8"
OUTSIDE DIAMETER x HEIGHT	6 ⁷ / ₈ " x 1 ¹ / ₂ "	8" x 2"
APPROX. CAPACITY	14.3 oz.	31.2 oz.
LIST PRICE EACH	\$ 15.85	\$ 18.55

Case Pack: 12

CROCKS AND LADLES

Crocks

- Resists stains and odors caused by vinegar, salad oils, or mayonnaise.
- Made of high impact FDA accepted material.
- Smooth surface is easy-to-clean.
- Works in Salad Bar Holder SBH15 and Crock Holder CPH3.

Solid Color Crock Colors:
Black (110), Beige (133),
Reddish Brown (195), White (148).
Lid Color: White (148).
Clear Crock Color: Clear (152).

*Lids for Solid Color and Clear Crocks are not interchangeable.



CODE	CAPACITY	CASE PACK	LIST PRICE EA.
Solid Color Crocks			
CP12	1.2 quart w/lid	12	\$ 12.65
CP15	1.5 quart w/lid	6	19.75
CP27	2.7 quart w/lid	6	21.00

Lids for Solid Color Crocks			
CPL12*	Fits CP12 crock	12	1.79
CPL27*	Fits CP15 & CP27 crock	12	1.85

Clear Crocks			
CCP12	1.2 quart w/lid	12	12.65
CCP15	1.5 quart w/lid	6	19.75
CCP27	2.7 quart w/lid	6	21.00

Lids for Clear Crocks			
CCPL12*	Fits CCP12 crock	12	1.79
CCPL27*	Fits CCP15 & CCP27 crock	12	1.85

CODE	HEIGHT	TOP DIAMETER	CUT OUT DIAMETER
Solid Color Crock with Lid			
CP12	5 ³ / ₁₆ "	5 ¹ / ₁₆ "	4 ³ / ₄ "
CP15	4 ⁵ / ₁₆ "	6 ⁵ / ₈ "	6 ³ / ₁₆ "
CP27	6 ¹ / ₄ "	6 ⁵ / ₈ "	6 ¹ / ₈ "
Clear Color Crock with Lid			
CCP12	5 ³ / ₈ "	5 ¹ / ₄ "	4 ¹ / ₈ "
CCP15	4 ³ / ₈ "	6 ³ / ₄ "	6 ¹ / ₄ "
CCP27	6 ³ / ₈ "	6 ³ / ₄ "	6 ³ / ₁₆ "

InStock Color: Black (110).

Camwear® Ladles

- Portion control bowls serve the perfect amount of dressing or food ingredient.
- Angled for easy handling.
- Designed with a side rest so ladles don't slip into crocks or serving bowls.
- Made of virtually unbreakable Camwear for years of dependable service.

Colors: Black (110), Beige (133), Clear (135), White (148).

*Cambro's assortment pack is available in black only. It offers 8 imprinted ladles and 4 with no imprinting. The 8 imprints include: 1 Thousand Island, 1 French, 1 House, 1 Italian, 1 Bleu Cheese, 1 Ranch, 1 Low Cal, 1 Caesar. This makes a perfect start-up set for a salad bar.

Custom Order Ladle Imprints – See personalization section for information, ordering and pricing. Maximum imprint area is 1" x 1/2". Six dozen minimum.

No broken cartons on assortment pack or imprinted ladles. Special order item not carried in stock, non-returnable.



Imprinted Ladles shown.

CODE	DESCRIPTION	LENGTH	CAPACITY	LIST PRICE EA.
LD85	Plain	8 ¹ / ₂ "	3/4 oz.	\$ 4.25
LD85A*	Assortment	8 ¹ / ₂ "	3/4	6.15
LD105	Plain	10 ⁹ / ₁₆ "	1	4.25
LD105A*	Assortment	10 ⁹ / ₁₆ "	1	6.15
LD130	Plain	13"	1	4.70

Case Pack: 12 InStock Color: Black (110).

SERVING SPOONS, CAMTENSILS® & TURNERS

Camwear® Serving Spoons

- Made of virtually unbreakable Camwear, spoons won't tarnish, bend or dent.
- A wide handle and molded in thumb rest ensure a solid, ergonomic grip.
- Spoons feature a notched back to rest on pans.
- Spoon capacities are approximate and are not intended for measuring.

Colors: Black (110), Beige (133), Clear (135), White (148) Red (404).

InStock Color: Black (110).

*Cannot be personalized.



Perforated



SPO10CW
DESCRIPTION: ¾ oz. 10" Perforated salad spoon
DIMENSIONS: 10¼" x 1¼"
LIST PRICE EACH: \$ 3.50
Case Pack: 12



SPO11CW*
DESCRIPTION: 11" Perforated deli spoon
DIMENSIONS: 11⅞" x 2⅞"
LIST PRICE EACH: \$ 4.30
Case Pack: 12



SPO13CW*
DESCRIPTION: 13" Perforated deli spoon
DIMENSIONS: 13⅞" x 2⅞"
LIST PRICE EACH: \$ 7.45
Case Pack: 12

See personalization section for information, ordering and pricing.

Solid



SP08CW
DESCRIPTION: ½ oz. 8" Salad spoon
DIMENSIONS: 8⅞" x 1½"
LIST PRICE EACH: \$ 3.25
Case Pack: 12



SP010CW
DESCRIPTION: ¾ oz. 10" Buffet spoon
DIMENSIONS: 10¼" x 1¼"
LIST PRICE EACH: \$ 3.50
Case Pack: 12



SP011CW*
DESCRIPTION: 11" Deli spoon
DIMENSIONS: 11⅞" x 2⅞"
LIST PRICE EACH: \$ 4.30
Case Pack: 12



SP013CW*
DESCRIPTION: 13" Deli spoon
DIMENSIONS: 13⅞" x 2⅞"
LIST PRICE EACH: \$ 7.45
Case Pack: 12

High Heat Camtensils, Spoons and Turners

- Ideal for preparing and serving hot and cold foods.
- Made of a durable high heat material that withstands temperatures from -40° to 375°F (-40° to 190°C).
- Handle includes a hole for hanging when not in use and notches to rest on pans.

Colors: Amber (150), Black (110).

InStock Color: Black (110).



SP013
DESCRIPTION: 13" Solid spoon
DIMENSIONS: 13⅞" x 2⅞"
LIST PRICE EACH: \$ 13.65
Case Pack: 12



SPA14
DESCRIPTION: 14" Solid turner
DIMENSIONS: 14⅞" x 3½"
LIST PRICE EACH: \$ 15.25
Case Pack: 12



SPOP13 PERFORATED
DESCRIPTION: 13" Perforated spoon
DIMENSIONS: 13⅞" x 2⅞"
LIST PRICE EACH: \$ 13.65
Case Pack: 12



SPASL14 SLOTTED
DESCRIPTION: 14" Slotted turner
DIMENSIONS: 14⅞" x 3½"
LIST PRICE EACH: \$ 15.25
Case Pack: 12



LUGANO® TONGS

Lugano Flat and Scallop Grip Tongs

- Flat Tongs are ribbed to provide a secure hold.
- Scallop Tongs feature an ergonomic design and secure finger grip.

FLAT GRIP



TG6
LENGTH: 6"
LIST PRICE EACH: \$ 3.15
Case Pack: 12



TG9
LENGTH: 9"
LIST PRICE EACH: \$ 5.00
Case Pack: 12

SCALLOP GRIP



6TGS
LENGTH: 6"
LIST PRICE EACH: \$ 3.30
Case Pack: 12



9TGS
LENGTH: 9"
LIST PRICE EACH: \$ 5.00
Case Pack: 12

Colors: Black (110), Beige (133), Clear (135), Red (404), White (148).

InStock Color: Black (110).



12TGS
LENGTH: 12"
LIST PRICE EACH: \$ 7.60
Case Pack: 12



Lugano Angled and Easy-Grasp Tongs

- Angled tongs feature an ergonomic design that makes it easy to serve a variety of foods.
- Easy-Grasp Tongs provide a secure grip for hard to hold items.

Angled Tong Color: Black (110).

Easy-Grasp Tong Colors: Black (110), Beige (133), Clear (135), White (148).

InStock Color: Black (110).



ANGLED TONG



TGA8
LENGTH: 8³/₄"
LIST PRICE EACH: \$ 4.90
Case Pack: 12



TGA11
LENGTH: 10¹³/₁₆"
LIST PRICE EACH: \$ 5.85
Case Pack: 12

EASY-GRASP



TGG6
LENGTH: 6⁷/₁₆"
LIST PRICE EACH: \$ 4.90
Case Pack: 12



TGG9
LENGTH: 9¹/₂"
LIST PRICE EACH: \$ 5.35
Case Pack: 12



CAMVIEW® SHAKERS/DREDGES & CAMWEAR® CONDIMENT JARS

CamView Shakers/Dredges

- A staple in the kitchen, at the condiment station or on the dining table.
- Clear shatter-resistant CamView and color coded lids make it easy to identify contents.
- Dishwasher safe and unaffected by food acids.

Shaker Color: Clear (135).



96SKRLD
Salt & Pepper



96SKRLM
Med. Ground



96SKRLC
Cheese



96SKRLP
Parsley

CODE	COLOR	APPROX. CAPACITY	LIST PRICE EA.
Shakers Complete with Lids			
96SKRPP (w/parsley lid)	—	10	\$ 7.15
96SKRDP (w/salt & pepper lid)	—	10	7.15
96SKRPC (w/cheese lid)	—	10	7.15
96SKRMP (w/medium ground lid)	—	10	7.15
Case Pack: 12 InStock Color: Clear (135).			

Lids			
96SKRPLP parsley lid	White (148)	—	1.29
96SKRPLD salt & pepper lid	Beige (406)	—	1.32
96SKRPLC cheese lid	Yellow (405)	—	1.32
96SKRPLM medium ground lid	Rose (408)	—	1.32
Case Pack: 12			

Camwear Condiment Jars

- Use to hold condiments such as mustard, ketchup, dressings, jam or salsa.
- Made of clear, virtually unbreakable Camwear.
- Lids are slotted to hold serving spoons when not in use.

Color: Clear (135).



CODE	APPROX. CAPACITY	SIZE H x DIA.	CASE PACK	LIST PRICE EA.
Jar & Cover				
CJ80CW*	8 oz.	4" x 3 3/4"	24	\$ 10.20

*Spoons not included.

CAMWEAR® DISPLAY COVERS & TRAYS

- Display covers protect freshness of pastries, breads and desserts.
- Virtually unbreakable Camwear features the upscale look of glass.
- Openings on side or end provide quick and easy access to contents without removing cover.

Display Covers Color: Clear (135).

Display Tray Colors:
Clear (135), Black (110).



Display Trays are stackable.
Display Trays cannot be personalized.
Refer to Market Tray page for information.



RD1200CW



RD1220CW



RD1220CWH



*DD1220BECW



DD1220SCW



Display Tray – DT1220CW

CODE	DESCRIPTION	APPROX. DIMENSIONS W x D x H*	CASE PACK	LIST PRICE EA.
Display Covers				
RD1200CW	Cake cover	12" x 12" x 8¼"	1	\$ 36.95
DD1220CW	Dome cover	21⅞" x 14¾" x 8"	1	64.00
DD1220ECW	Dome w/end cut	21⅞" x 14¾" x 8"	1	80.75
DD1220BECW	Dome w/2 ends cut	21⅞" x 14¾" x 8"	1	98.25
DD1220SCW	Dome w/side cut	21⅞" x 14¾" x 8"	1	80.75
DD1826CW	Dome cover	26¾" x 18⅞" x 8⅞"	1	89.50
RD926CW	Rectangular cover	26⅞" x 10" x 6¼"	1	59.50
RD1220CW	Rectangular cover	21⅞" x 14⅞" x 5⅞"	1	67.50
RD1220CWH	Rectangular w/hinge	21⅞" x 14⅞" x 5"	1	96.00
RD1826CW	Rectangular cover	26⅞" x 18⅞" x 6¼"	1	87.50
RD1826CWH	Rectangular w/hinge	26¾" x 18¾" x 5⅞"	1	102.25
Display Tray – Fits with all 1220 Covers				
DT1220CW	Tray	12" x 20"	1	25.70
Market Tray – Fits with all 1826 Covers				
1826MT	Tray	25⅞" x 17⅞" x 1⅞"	6	43.00

*Dimensions include handle(s). Handle height is 13/16".

TRAYS AT A GLANCE

Patron Trays

Camtray®

The industry standard. Durable fiberglass construction.



43 SIZES	8 SHAPES	53 COLORS
-------------	-------------	--------------



Non-Slip Service Trays

Camtread® Trays

Durable fiberglass construction with non-skid surface. Grips service items to avoid spills.



16 SIZES	3 SHAPES	2 COLORS
-------------	-------------	-------------



Camlite® Tray

Combine economy with durability. Fiberglass construction.



6 SIZES	1 SHAPE	9 COLORS
------------	------------	-------------



Treadlite™ Tray

Fiberglass reinforced polyester lightweight tray with molded in non-skid surface ensures items stay in place during service.



2 SIZES	1 SHAPE	2 COLORS
------------	------------	-------------



Camwear® Trays

Made of durable Camwear.



3 SIZES	3 SHAPES	5 COLORS
------------	-------------	-------------



Polytread® Trays

General purpose tray with non-skid surface.



6 SIZES	2 SHAPES	2 COLORS
------------	-------------	-------------



Fast Food Tray

Economical choice that withstands frequent use.



3 SIZES	1 SHAPE	14 COLORS
------------	------------	--------------



Décor Series Camtrays

Woodgrain textured surface with durability of the classic Camtray. Also available in clear EpicTread non-slip surface.



3 SIZES	1 SHAPE	4 COLORS
------------	------------	-------------



Healthcare Dietary Tray

Low profile offers patient comfort. Made of durable fiberglass. Camtray and Non-Skid Versa Camtrays are also recommended for patient meal delivery.



6 SIZES	1 SHAPE	53 COLORS
------------	------------	--------------



Camwear Non-Skid Tray

Made of durable Camwear. Non-skid surface grips items firmly.



2 SIZES	2 SHAPE	3 COLORS
------------	------------	-------------



TRAYS AT A GLANCE

Non-Skid Versa Camtrays®

Non-Skid Versa Trays reduce waste, save money and provide a stable tray surface for meal delivery.



2 SIZES	3 SHAPES	3 COLORS
------------	-------------	-------------



Compartment Serving Trays

Compartment configurations to meet all menu requirements. Warranty varies by material.



3 SIZES	3 SHAPES	7 COLORS
------------	-------------	-------------



Service Trays

Hotel Room Service Tray

Lightweight yet durable service tray features a contemporary design.



1 SIZE	1 SHAPE	3 COLORS
-----------	------------	-------------



Separator® Compartment Trays

Tray with cover separates each compartment to retain food temperature and reduce spills. Warranty varies by material.



2 SIZES	1 SHAPE	4 COLORS
------------	------------	-------------



Display Trays

Market Trays and Pans

Ideal for merchandising food items in showcases. Durable fiberglass construction.

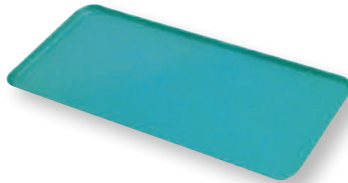

19 SIZES	1 SHAPE	5 COLORS
-------------	------------	-------------



Tray on Tray Meal Delivery System

Use Insert Tray and Base Tray to serve hot and cold foods together. Warranty varies by material.



3 SIZES	2 SHAPES	4 COLORS
------------	-------------	-------------



Compartment Trays

Compartment Tray

Six compartment tray available in three materials. Warranty varies by material.



1 SIZE	1 SHAPE	10 COLORS
-----------	------------	--------------



Meal Delivery Trays

Deep compartments and snap-on cover. Warranty varies by material.

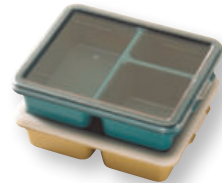

2 SIZES	2 SHAPES	4 COLORS
------------	-------------	-------------



2 x 2 Compartment Trays

Durable trays with easy grip handles. Trays fit side by side in dishrack to reduce warewashing expense. Warranty varies by material.



2 SIZES	2 SHAPES	9 COLORS
------------	-------------	-------------



PROMOTE YOUR BRAND — PERSONALIZED CAMTRAY®

Personalize Camtrays to display a message with every tray served. Advertise a product or a brand, promote your business, enhance patient satisfaction or strengthen school spirit. All personalized tray orders are full case quantities only, no broken cartons.

Personalization Charges:

QUANTITY EACH	NET CHARGE PER TRAY
144-299	\$ 0.50
300 and up	Free



Look for this icon that identifies items that can be personalized.

Digital Printing - Edge to Edge:

- Multiple color artwork.
- Print area covers 100% of surface, edge to edge on top and bottom of the tray.
- Order minimum 144 each.
- Available for Decor Series Camtrays and select Camtrays.



Digital Printing - Inside Trays:

- Multiple color artwork as well as photo reproduction.
- Processing requires light colors trays only.
- Printable area up to 1" from the internal tray edge.
- Order minimum 144 each.



Silkscreen Printing Personalization:

- Up to four colors.
- Best for light color artwork on dark color trays.
- Order minimum 144 each.

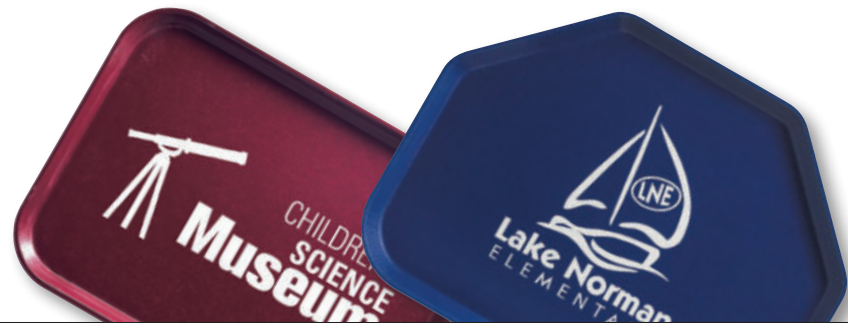

HOW TO ORDER A SAMPLE

1. Request a Sample

Contact your local Cambro Representative to complete and submit sample request form to Cambro. Form MUST BE submitted along with artwork.

2. Provide Artwork

Must be ready to use, digital format only. Email to Cambro

Representative or to Cambro at letsgetpersonal@cambro.com. Title email subject with logo name. Provide contact info. If artwork is incomplete, graphic services are available for \$50.00 per hour.

File Dimensions:

100% reproduction size, 300 dpi resolution.

File Type:

Adobe® Illustrator®, Photoshop®.

File Format: jpeg, tiff, and eps.

3. Sample Turnaround

7 - 10 business days from approval of artwork.

4. Sample Approval

Approval form included with each sample. Form must be completed and be included with the purchase order for order processing.

5. Sample Charge (NET)

\$50.00 per sample (charge billed on sample order, credited back on first purchase order).

6. Questions?

Contact our Personalization Team at 800-854-7631 Ext. 4125 or email letsgetpersonal@cambro.com.

CAMTRAY®

- Use in restaurants, hotel room service, cafeterias, food courts, hospitals and schools.
- Durable construction backed by five year prorated warranty against manufacturer's defects.
- Made of lightweight, high-impact fiberglass.

- Stain and odor resistant.
- Stacking lugs keep trays stacked securely in place and ensure proper air flow.



Rectangular Camtrays

The industry standard.

Available in Group I colors and patterns and Group III Wood.

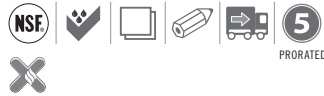

Trapezoid Camtrays

Saves tabletop space and increases seating capacity.

Available in Group I colors and patterns and Group III Wood.

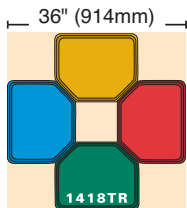
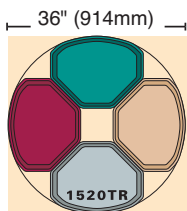
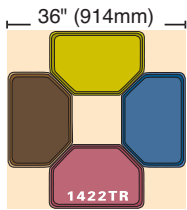
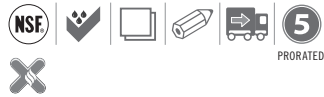

CODE	DIMENSIONS	CASE PACK	LIST PRICE EA.	
			GROUP I	GROUP III
Rectangular				
46	4¼" x 6"	12	\$ 6.40	\$ 8.90
57*	4 ¹⁵ / ₁₆ " x 6 ¹⁵ / ₁₆ "	12	6.95	9.70
810	8" x 9 ⁷ / ₈ "	12	15.25	19.75
915	8¾" x 15"	12	21.65	25.10
926*	8 ⁷ / ₈ " x 25 ⁵ / ₁₆ " x 1"	12	28.35	36.70
1014	10 ⁵ / ₈ " x 13 ³ / ₄ "	12	20.10	25.95
1216	12" x 16 ⁵ / ₁₆ "	12	23.25	30.50
1318*	12 ⁵ / ₈ " x 17 ³ / ₄ " x 1 ¹ / ₁₆ "	12	28.85	35.95
1418	14" x 18"	12	27.70	36.20
1520	15" x 20 ¹ / ₄ "	12	33.50	43.55
1622	16" x 22"	12	38.60	50.25
16225*	16 ¹ / ₂ " x 22 ¹ / ₂ "	12	42.30	53.00
1826	17 ⁷ / ₈ " x 25 ³ / ₄ "	6	51.50	66.25
2025*	20 ³ / ₄ " x 25 ⁵ / ₁₆ "	6	62.75	76.50
Trapezoid				
1418TR	14" x 18"	12	26.35	35.55
1422TR*	14" x 22"	12	28.85	39.05
1520TR*	14 ⁹ / ₁₆ " x 19 ¹ / ₂ "	12	30.70	40.05

InStock Colors: Antique Parchment (101), Black (110). *Special order item not carried in stock, non-returnable. One case order minimum.

CAMTRAY®

Oval Camtrays

Perfect for banquet service.

Available in Group I colors and patterns (except Doily patterns) and Group III Wood.

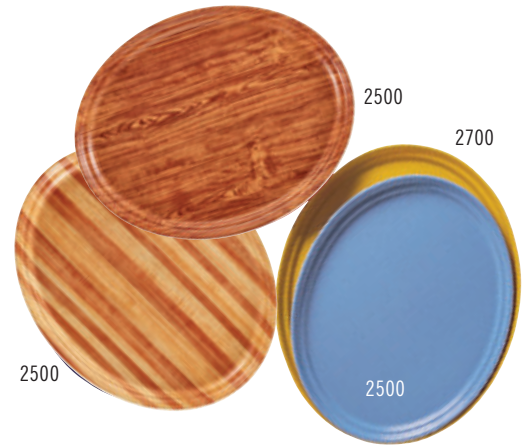

Round Camtrays

A favorite for pizza and beverage service.

Available in Group I colors and patterns (except Doily patterns) and Group III Wood.

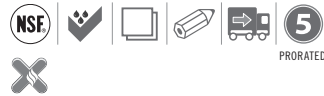

Insert Camtrays

Fits onto a Camtray to separate hot and cold food, ideal for dietary tray service.

Available in Group I colors and patterns (except Doily patterns) and Group III Wood.

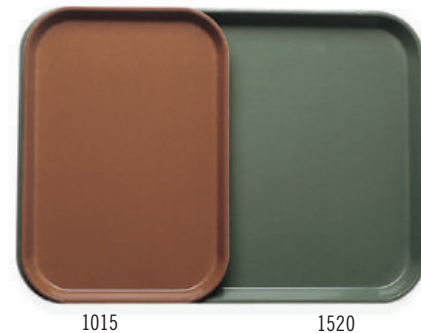

CODE	DIMENSIONS	CASE PACK	LIST PRICE EA.	
			GROUP I	GROUP III
Oval				
2500*	19 $\frac{1}{4}$ " x 24"	6	\$ 50.25	\$ 50.25
2700*	22" x 26 $\frac{1}{8}$ "	6	58.50	77.50
Round				
900*	9"	12	15.40	19.55
1000*	10"	12	17.05	22.25
1100	11"	12	17.05	21.60
1200*	12"	12	18.80	25.25
1300*	13"	12	20.85	27.45
1400	14"	12	21.15	28.75
1550*	16" low profile	12	27.10	35.30
1600	16"	12	26.55	35.55
1950*	19 $\frac{1}{2}$ " low profile	12	36.70	48.40
Insert				
1015* 2 trays fit into a 1520	10 $\frac{3}{8}$ " x 15"	24	20.85	26.90
1116* 2 trays fit into a 1622	10 $\frac{3}{8}$ " x 15 $\frac{1}{8}$ "	24	21.70	30.50

*Special order item not carried in stock, non-returnable.

CAMTRAYS® WITH HANDLES, DIETARY TRAYS AND METRIC CAMTRAY

Camtrays with Handles

- Enhance your tray presentation and improve your customer's experience with these easy-to-grip, ergonomic, contoured handles.
- Made of durable, lightweight and high-impact fiberglass.
- Stacking lugs keep trays stacked securely in place and ensure proper air flow.
- Dishwasher safe at high and low temperatures.

Available in Group I colors.
 Special order item not carried in stock, non-returnable. One case order minimum.
 NSF listed for non-direct food contact only.
 Personalization through digital printing process only. Please refer to Camtray Personalization section for details.
 Camtrays with handles is covered by U.S. Patent D 683,191 S.

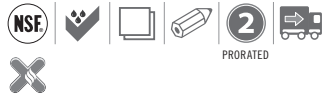

CODE	DIMENSIONS	LIST PRICE EA.
1418H	14" x 18"	\$ 31.45
1520H	15" x 20"	37.40

Case Pack: 12

Healthcare Dietary Trays

- Designed specifically for in-room patient feeding.
- Low slope edge provides easy access when dining from a hospital bed.
- Made of lightweight fiberglass.

Available in Group I colors and patterns and Group III Wood.
 NSF listed for non-direct food contact only.
 Personalization through digital printing process only. Please refer to Camtray Personalization section for details.
 Camtrays with handles is covered by U.S. Patent D 683,191 S.



CODE	DIMENSIONS	CASE PACK	LIST PRICE EA.	
			GROUP I	GROUP III
Dietary				
1216D*	12" x 16"	12	\$ 24.00	\$ 31.80
1219D*	12" x 19"	12	28.15	36.40
1220D*	12" x 20"	12	30.55	39.20
1222D*	12" x 22"	12	30.55	39.15
1418D*	14" x 18"	12	27.95	36.95
1520D*	15" x 20 ³ / ₁₆ "	12	33.25	42.05

*Special order item not carried in stock, non-returnable.

Metric Camtrays

Designed to meet international specifications.

Available in Group I colors and patterns and Group III Wood. 3555TR is available in Group I colors and patterns except Doily.



CODE	DIMENSIONS	CASE PACK	LIST PRICE EA.	
			GROUP I	GROUP III
Metric				
1313*	13" x 13" (33 x 33 cm)	12	\$ 20.85	\$ 27.30

*Special order item not carried in stock, non-returnable.



1313

Other sizes available on www.cambro.com.

CAMTRAY® GROUP I COLORS

Colors listed alphabetically. See numerical reference on following page.



123
Amazon Blue



101
Antique Parchment



513
Bay Leaf Brown



110
Black



409
Blush



116
Brazil Brown

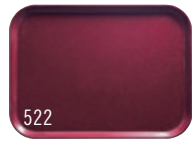

522
Burgundy Wine



521
Cambro Red



537
Cameo Yellow

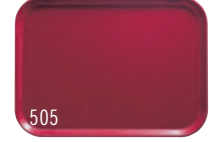

505
Cherry Red



220
Citrus Orange



538
Cottage White



117
Dark Peach



104
Desert Tan



514
Earthen Gold



221
Ever Red

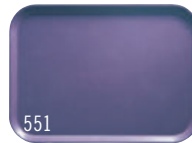

551
Grape



105
Horizon Blue



429
Key Lime



536
Lemon Chiffon



106
Light Peach



113
Lime-ade



504
Mustard



428
Olive Green



222
Orange Pizzazz



107
Pearl Gray



410
Raspberry Cream



501
Real Rust



518
Robin Egg Blue



119
Sherwood Green



510
Signal Red



177
Sky Blue



401
Slate Blue



508
Suede Brown



199
Taupe



414
Teal



171
Tuscan Gold



148
White

Due to the catalog printing process, the colors & patterns shown may not be exact.
Contact Cambro or a Cambro representative for a color chip.

CAMTRAY® GROUP I PATTERNS

Galaxy



526
531
Antique Parchment
Gold (526), Silver (531)

Swirl

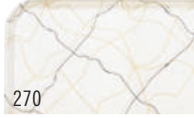

270
Black & Gold **NR**



277
Gray **NR**

Doily



241
Antique Parchment **NR**

Abstract

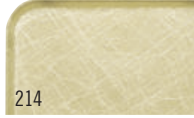

214
Tan **NR**



215
Gray **NR**

NR Trays are
non-returnable.



CAMTRAY GROUP III WOOD

Wood



308
Burma Teak **NR**



304
Country Oak **NR**



301
Dark Basketweave **NR**



309
Java Teak **NR**

Linen

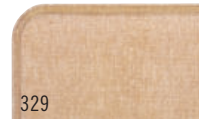

329
Toffee **NR**

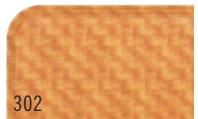

302
Light Basketweave **NR**



303
Light Butcher Block **NR**



307
Light Elm **NR**



204
Rattan **NR**

NR Trays are
non-returnable.

CAMTRAY GROUP I COLORS – NUMERICAL REFERENCE BY COLOR CODE

Antique Parchment (101),
Desert Tan (104), Horizon Blue (105),
Light Peach (106), Pearl Gray (107),
Black (110), Lime-ade (113),
Brazil Brown (116), Dark Peach (117),
Sherwood Green (119),

Amazon Blue (123), White (148),
Tuscan Gold (171), Sky Blue (177),
Taupe (199), Citrus Orange (220),
Ever Red (221), Orange Pizzazz (222),
Slate Blue (401), Blush (409),
Raspberry Cream (410), Teal (414),

Olive Green (428), Key Lime (429),
Real Rust (501), Mustard (504),
Cherry Red (505), Suede Brown (508),
Signal Red (510), Bayleaf
Brown (513), Earthen Gold (514),

Robin Egg Blue (518), Cambro
Red (521), Burgundy Wine (522),
Lemon Chiffon (536), Cameo
Yellow (537), Cottage White (538),
Grape (551).

Due to the catalog printing process, the colors & patterns shown may not be exact.
Contact Cambro or a Cambro representative for a color chip.

DÉCOR SERIES CAMTRAYS®

- Woodgrain textured surface creates the look feel of real wood.
- Durability of the classic Camtray.
- Ideal for upscale employee feeding, restaurant, cafeteria, schools, food courts and hospitals.
- Personalize a portion or an entire tray surface with a full color logo or design.
- Made of lightweight high-impact fiberglass.
- Commercial dishwasher safe.

Colors: Charcoal Gray (815), Light Olive (820), Dark Oak (825), Light Oak (830).

Personalization with a minimum order of 144 trays.



Charcoal Gray (815)

CODE	DIMENSIONS	CASE PACK	LIST PRICE EA.
1216DC	12" x 16"	12	\$ 30.50
1418DC	14" x 18"	12	36.20
1520DC	15" x 20"	12	43.55

DÉCOR SERIES EPICTREAD™ CAMTRAYS

- The Décor Series design and texture with our clear EpicTread non-slip surface.
- Perfect for busy cafeterias to reduce food and dish spills.
- An excellent solution for hospital foodservice to provide a beautiful patient tray presentation without a paper tray mat.
- Personalize a portion or an entire tray surface with a full color logo or design.
- Commercial dishwasher safe.

Colors: Charcoal Gray (815), Light Olive (820), Dark Oak (825), Light Oak (830).

Personalization with a minimum order of 144 trays.



Light Olive (820)

Dark Oak (825)

Light Oak (830)

CODE	DIMENSIONS	CASE PACK	LIST PRICE EA.
1216DCET	12" x 16"	12	\$ 37.70
1418DCET	14" x 18"	12	48.80
1520DCET	15" x 20"	12	54.75

NON-SKID VERSA CAMTRAYS®



- Non-Skid Camtrays provide a better grip for safer meal delivery.
- Dishwasher safe in low and high temperatures.
- Stacking lugs keep trays stacked securely in place and ensure proper air flow.
- Ergonomic handles allow for safe and elegant meal delivery.
- Trays fit within existing meal delivery carts, that accommodate 15" x 20" and 14" x 18" trays.

Colors: Black with Pebbled Black (382), Pearl Gray with Titan (381), Ivory with Sahara (380).

Non-Skid Versa Camtrays with Handles are covered by U.S. Patent D 683,191 S.

NSF listed for splash zone only.



Personalization available. Visit www.cambro.com for details.

1418VCH



1418VC

Black with Pebbled Black (382)

Pearl Gray with Titan (381)

Ivory with Sahara (380)

CODE	DIMENSIONS	CASE PACK	LIST PRICE EA.
Non-Skid Versa Camtrays			
1418VC	14" x 18"	12	\$ 48.80
1520VC	15" x 20"	12	54.75
Non-Skid Versa Camtrays with handles			
1418VCH	14" x 18"	12	51.00
1520VCRST	15" x 20"	12	57.50

CAMWEAR® TRAYS

Camwear Trays

- Ideal for use in correctional facilities.
- Made from durable Camwear.
- Stacking lugs keep trays stacked securely in place and ensure proper air flow.

1418CW, 1520CW, 1418TRCW Colors:
Blue (168), Beige (133).

1418CWH, 1520CWH Colors:
Black (110), Smoked Metal (485),
Dark Cranberry (488).

NSF listed for splash zone only.



CODE	DIMENSIONS	CASE PACK	LIST PRICE EA.
Rectangular			
1418CW	13 ¹⁵ / ₁₆ " x 17 ¹⁵ / ₁₆ "	12	\$ 30.75
1520CW	14 ⁷ / ₈ " x 20 ⁷ / ₈ "	12	32.00
Rectangular with Handles			
1418CWH	13 ¹⁵ / ₁₆ " x 17 ¹⁵ / ₁₆ "	12	42.60
1520CWH	14 ⁷ / ₈ " x 20 ⁷ / ₈ "	12	47.65
Trapezoid			
1418TRCW	14" x 18"	12	30.75



Camwear Non-Skid Trays

- Ideal for use in high-traffic cafeterias.
- Made from durable Camwear.
- Non-skid clear textured surface is scratch resistant and ensures drinks and meals stay in place during transport.
- Stacking lugs keep trays stacked securely in place and ensure proper air flow.
- Commercial dishwasher safe at high and low temperatures.

Colors: Black (110), Smoked Metal (485),
Dark Cranberry (488).

These trays are not recommended for use in heated carts.

NSF listed for splash zone only.



Black (110)

Dark Cranberry (488)

Smoked Metal (485)

CODE	DIMENSIONS	CASE PACK	LIST PRICE EA.
Non-skid tray			
1418CWNS	14" x 18"	12	\$ 48.40
1520CWNS	15" x 20"	12	54.25
Non-skid tray with handles			
1418CWNSH	14" x 18"	12	50.00
1520CWNSH	15" x 20"	12	57.00

1418CWNS and 1520CWNS InStock Colors: Black (110), Smoked Metal (485),
Dark Cranberry (488). **1520CWNSH InStock Colors:** Black (110),
Smoked Metal (485).



HOTEL ROOM SERVICE TRAY

- Lightweight, weighs up to 30% less than wood room service trays.
- Dishwasher safe once a day, easily wipes clean. Saves time and labor.
- Standard 14" x 19" tray mat can be used on the surface of the tray.

Colors: Brushed Steel (612), Venge (384), Walnut (376).

NSF listed for splash zone only.

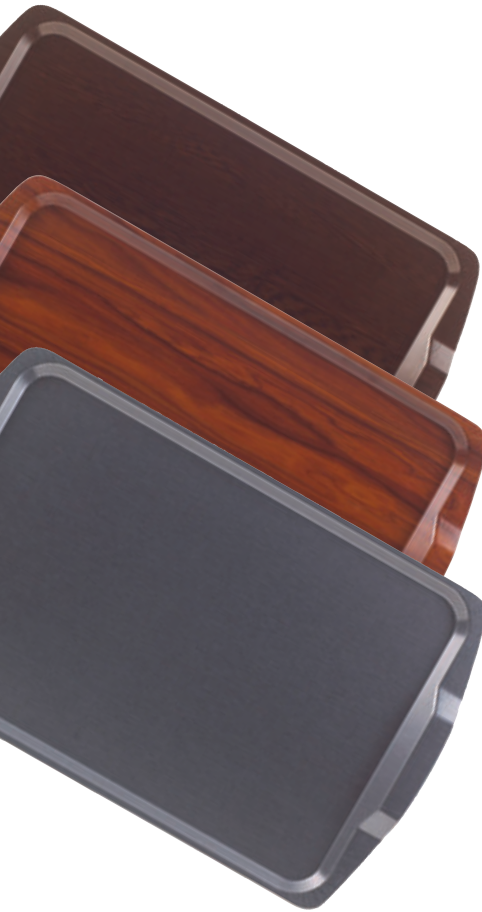

Venge
(384)

Walnut
(376)

Brushed
Steel
(612)

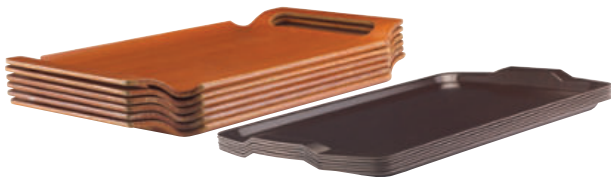

Up to 50% greater stacking capacity than comparable wood trays.

CODE	OUTER DIMENSION	INNER DIMENSION	LIST PRICE EA.
1525RST	15½" x 25"	14" x 21"	\$ 40.25

Case Pack: 12



CAMTREAD® TRAYS

- An industry standard for caterers, hotels, banquet halls, dining rooms and bars.
- Non-skid surface ensures drinks and meals stay in place during transport.
- Made of heavy-duty, durable fiberglass with a thick molded in, non-skid surface.

Orders for non-standard Camtread Tray colors will be handled by special quotation only.

*Special order item not carried in stock, non-returnable. One case order minimum.

Not for use in heated carts.

**Personalization available on 1600CT only.



Non-skid trays mean less breakage and greater profits.

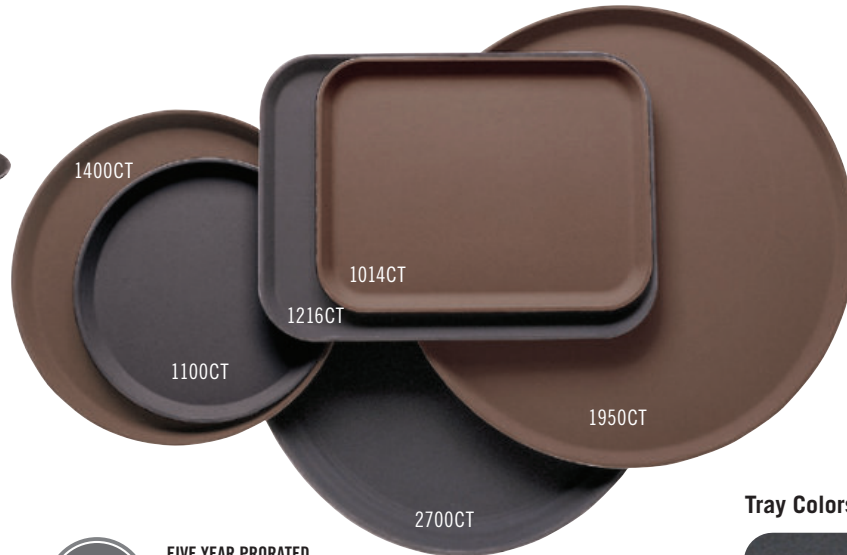

FIVE YEAR PRORATED WARRANTY AGAINST MANUFACTURER'S DEFECTS

Tray Colors:



CODE	DIMENSIONS	CASE PACK	LIST PRICE EA.
Round			
900CT*	9"	12	\$ 24.50
1100CT	11"	12	24.50
1400CT	14"	12	32.60
1550CT*	16" low profile	12	44.25
1600CT**	16"	12	42.95
1800CT	18"	6	61.00
1950CT*	19 ⁷ / ₁₆ " low profile	12	62.50
Oval			
2500CT	19 ³ / ₄ " x 23 ³ / ₈ "	6	77.50
2700CT	22" x 26 ³ / ₈ "	6	87.25
2900CT	28 ⁷ / ₈ " x 23 ¹ / ₂ "	6	99.25
Rectangular			
1014CT*	10 ⁵ / ₈ " x 13 ³ / ₄ "	12	30.20
1216CT*	12" x 16 ³ / ₁₆ "	12	34.90
1418CT	14" x 18"	12	43.45
1520CT*	15" x 20 ¹ / ₄ "	12	49.40
1622CT*	16" x 22"	12	61.00
1826CT	17 ¹³ / ₁₆ " x 25 ¹¹ / ₁₆ "	6	73.25
3253CT*	12 ³ / ₄ " x 20 ⁷ / ₈ "	12	51.00

InStock Colors: Black Satin (110), Tavern Tan (138).
1950CT and 3253CT special order only available in Tavern Tan (138).

TREADLITE™ TRAY

- Fiberglass reinforced polyester lightweight tray has a molded in non-skid surface.
- Non-skid surface ensures items stay in place during service.
- Reinforced edges provide superior strength and protection.
- Stacking lugs keep trays stacked securely in place and ensure proper air flow.



CODE	DIAMETER	LIST PRICE EA.
1400TL	14"	\$ 19.60
1600TL	16"	26.15

Case Pack: 12 InStock Colors: Black Satin (110), Tavern Tan (138).

Tray Colors:



POLYTREAD® TRAYS

- An economical service tray for restaurants, bars and banquet service.
- General, all-purpose, non-skid service trays help reduce spills and breakage.
- Non-skid surface is bonded directly into a lightweight polypropylene tray.
- Stacking lugs keep trays stacked securely in place and ensure proper air flow.



CODE	DIMENSIONS	CASE PACK	LIST PRICE EA.
Round			
PT1100	11"	12	\$ 13.90
PT1400	14"	12	18.65
PT1600	16"	12	25.20
Rectangular			
PT1014	10 ¹ / ₁₆ " x 13 ³ / ₈ "	24	17.90
PT1216	11 ⁷ / ₈ " x 16 ¹ / ₄ "	24	19.50
PT1418	14" x 18"	12	24.60



Tray Colors:

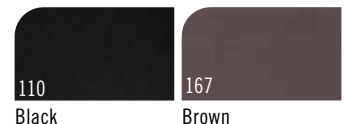

PROMOTE YOUR BRAND — PERSONALIZED CAMTREAD® TRAYS

Personalize Camtread Trays to display a message with every tray served. Advertise a product, a brand or promote your business. Personalized tray orders are full case quantities only, no broken cartons.

Personalization Charges:

QUANTITY EACH	NET CHARGES PER TRAY
144-299	\$ 0.50
300 and up	Free

White trays are recommended for tray back personalization.



Look for this icon that identifies items that can be personalized.

Tray Back — Digital Printing Personalization:

- Multiple color artwork as well as photo reproduction.
- Printable area up to 1" from the external tray edge.
- Available for 1600CT Tray, Black Tread with White Bottom only.
- Order minimum 144 each.



Tray Top — Emboss Personalization:

- Available for all Camtread Trays.
- Embossing area up to 1" from the internal tray edge.
- Order minimum 144 each.

Personalization Charges:

- Custom Emboss Plate \$500.00 Net (one-time charge, billed on first purchase order).
- Embossing Charge: \$1.00 Net per Tray.



HOW TO ORDER A SAMPLE

1. Request a Sample

Contact your local Cambro Representative to complete and submit sample request form to Cambro. Form **MUST BE** submitted along with artwork.

2. Provide Artwork

Must be ready to use, digital format only. Email to Cambro Representative or to Cambro at letsgetpersonal@Cambro.com. Title email subject with logo name.

Provide contact info. If artwork is incomplete, graphic services are available for \$50.00 per hour.

File Dimensions:

100% reproduction size, 300 dpi resolution.

File Type:

Adobe® Illustrator®, Photoshop®.

File Format: jpeg, tiff, and eps.

3. Sample Turnaround

7 – 10 business days from approval of artwork.

4. Sample Approval

Approval form included with each sample. Form must be completed and be included with the purchase order for order processing.

5. Sample Charge (NET)

\$50.00 per sample (charge billed on sample order, credited back on first purchase order).

6. Questions?

Contact our Personalization Team at 800-854-7631 Ext. 4125 or email letsgetpersonal@Cambro.com.

FAST FOOD TRAY

- Perfect for self-serve or quick-serve dining.
- Made of durable polypropylene.
- Attractive textured surface hides scratches.



Available Colors:



CODE	DIMENSIONS	CASE PACK	LIST PRICE EA.
1014FF	10 ⁷ / ₁₆ " x 13 ³ / ₁₆ "	24	\$ 6.40
1216FF	11 ⁷ / ₈ " x 16 ⁷ / ₈ "	24	7.70
1418FF	13 ¹³ / ₁₆ " x 17 ³ / ₄ "	12	9.85

InStock Colors: Black (110), Red (163).

PROMOTE YOUR BRAND – PERSONALIZED FAST FOOD TRAYS

Personalize Fast Food Trays and display an important message with every tray put into service. Advertise a product or a brand, promote your business or strengthen school spirit. Personalized tray orders are full case quantities only, no broken cartons.

Hot Stamp Personalization

- Single color imprint only.
- Choose from 12 standard imprint colors.
- Maximum imprint size: 5" x 5".
- Print area is 1" from internal side.
- Order minimum 288 each.

QUANTITY EACH	NET CHARGES PER TRAY
288-767	\$ 0.36
768-1199	0.27
1200-5999	0.18
6000-11,999	0.14
12,000 +	0.12

HOW TO ORDER A SAMPLE

1. Request a Sample

Contact your local Cambro Representative to complete and submit sample request form to Cambro. Form MUST BE submitted along with artwork.

2. Provide Artwork

Must be ready to use, digital format only. Email to Cambro Representative or to Cambro at letsgetpersonal@Cambro.com. Title email subject with logo name. Provide contact info. If artwork is incomplete, graphic services are available for \$50.00 per hour.

File Dimensions:

100% reproduction size, 300 dpi resolution.

File Type:

Adobe® Illustrator®, Photoshop®.

File Format: jpeg, tiff, and eps.

3. Sample Turnaround

7 – 10 business days from approval of artwork.

4. Sample Approval

Approval form included with each sample. Form must be completed and be included with the purchase order for order processing.

5. Sample Charge (NET)

\$50.00 per sample (charge billed on sample order, credited back on first purchase order).

6. Custom Die Charge (net)

\$150.00 per die (one-time charge, billed on first purchase order).

7. Questions?

Contact our Personalization Team at 800-854-7631 Ext. 4125 or email letsgetpersonal@Cambro.com.

CHOOSE ONE OR TWO STANDARD IMPRINT COLORS



Due to the catalog printing process, the colors shown may not be exact.



MARKET TRAYS AND PANS

- Attractively merchandise desserts, pastries, hors d'oeuvres and salads.
- Ideal for use in bakeries, supermarkets and delis.
- High-impact resistant fiberglass.
- Trays and pans resist odors and will not oxidize like aluminum trays.
- Pans feature a 2" rim for salads and ready to eat foods.

Colors: Yellow (145)*, Blue (142), Green (140), White (148), Black (110).

*NSF listed for splash zone only.



Market Trays make appealing bakery merchandising quick and easy.



Market Pans showcase deli items.

CODE	DIMENSIONS W x L x D	CASE PACK	LIST PRICE EA.
Market Trays			
630MT	6 ¹ / ₁₆ " x 30" x 3 ¹ / ₄ "	12	\$ 26.60
826MT	8 ¹ / ₄ " x 25 ¹ / ₂ " x 3 ¹ / ₄ "	12	21.75
830MT	8 ¹ / ₁₆ " x 30" x 3 ¹ / ₄ "	12	30.05
913MT	8 ⁷ / ₈ " x 12 ³ / ₄ " x 1"	12	23.30
918MT	8 ¹¹ / ₁₆ " x 18" x 1 ¹³ / ₁₆ "	12	25.30
926MT	8 ⁷ / ₈ " x 25 ³ / ₁₆ " x 1"	12	28.10
1015MT	10 ⁵ / ₁₆ " x 15" x 3 ¹ / ₄ "	24	21.10
1030MT	10 ⁷ / ₁₆ " x 30" x 3 ¹ / ₄ "	12	33.30
1218MT	11 ¹ / ₂ " x 17 ³ / ₄ " x 1"	12	26.30
1224MT	12 ⁷ / ₁₆ " x 24" x 3 ¹ / ₄ "	12	32.95
1230MT	12 ⁷ / ₁₆ " x 30" x 3 ¹ / ₄ "	12	38.20
1318MT	12 ⁵ / ₈ " x 17 ³ / ₄ " x 1 ¹ / ₁₆ "	12	27.00
1826MT	17 ¹³ / ₁₆ " x 25 ¹¹ / ₁₆ " x 1 ¹ / ₁₆ "	6	43.00
2025MT	20 ³ / ₄ " x 25 ¹ / ₁₆ " x 1 ¹³ / ₁₆ "	6	56.25
Market Pans			
6302MT	6 ¹ / ₁₆ " x 30" x 2"	12	41.70
8262MT	8 ³ / ₈ " x 25 ¹ / ₂ " x 2"	12	34.15
8302MT	8 ¹ / ₁₆ " x 30" x 2"	12	45.95
92615MT	8 ⁷ / ₈ " x 25 ¹ / ₂ " x 1 ¹ / ₂ "	12	28.05
10302MT	10 ⁷ / ₁₆ " x 30" x 2"	12	49.10

Special order item not carried in stock, non-returnable. One case order minimum.

CAMLITE® TRAYS

- An economical, all-purpose tray for self-serve food service dining.
- Made of fiberglass with reinforced corners.
- Stacking lugs keep trays stacked securely in place and ensure proper air flow.

Colors: Rose Red (163), Yellow (145), Green (162), Blue (142), Tan (161), Steel White (676), Steel Red (675), Steel Blue (674), Black (110).



CODE	DIMENSIONS	CASE PACK	LIST PRICE EA.
Rectangular			
1014CL	10 ⁵ / ₈ " x 13 ³ / ₄ "	12	\$ 19.25
1216CL	12" x 16 ⁵ / ₁₆ "	12	21.70
1418CL	14" x 18"	12	24.80
1520CL	15" x 20 ¹ / ₄ "	12	28.35
1826CL	17 ⁷ / ₈ " x 25 ³ / ₄ "	12	40.75
3253CL	12 ³ / ₄ " x 20 ⁵ / ₈ "	12	24.50

COMPARTMENT TRAY

- Perfect for school lunch programs or cafeteria-style feeding in correctional facilities.
- Textured surface resists scratching.
- All are FDA approved for food contact.
- Camwear® is made with virtually unbreakable material.
- Budget is made with ABS.
- Penny-Saver is made with economical co-polymer.

ABS and Co-Polymer trays are not NSF listed.



Cambro Trays

Saves 110 lbs of trash in disposable trays per day or 9.26 tons of trash per year from trays for just one school district.*

*This number is approximate. The average school district in the U.S. is about 10,000 students and the average number of in-session school days is 175.



PS1014

150CW, 100CW, 50CW, 45CW, 35CW, 10CW and SRB5CW reusable bowls fit in this tray and can be used to serve cereal, soup & salads.



BCT1014



BCT1014, PS1014 & 10146CW

Camwear Colors



Budget Colors



Penny-Saver Colors



CODE	DIMENSIONS W x L x D	LIST PRICE EA.
Camwear		
10146CW	10" x 14½" x ¾"	\$ 16.90
Budget - BPA FREE		
BCT1014	10" x 14½" x ¾"	12.90
Penny-Saver - BPA FREE		
PS1014	10" x 14½" x ¾"	8.05
Case Pack: 24		



PS1014 on OETR314 Open End Tray Rack.

2 X 2 COMPARTMENT TRAYS

- Perfect for school lunch programs or cafeteria-style feeding in correctional facilities.
- Gradual sloping compartment walls promote quick draining and faster drying.
- "Easy grip" handles ensure a better grip for children with smaller hands.
- 915CW, 100CW, SRB13CW and 50CW bowls fit in round compartment.
- 10CW and 150CW bowls fit in square compartment.

Camwear® trays are NSF Listed.

Co-Polymer trays are not NSF listed.



Styrofoam, the material that many disposable trays are made from, can make up to 30% of the trash volume in landfills.

Cambro Trays are made from FDA approved materials.

Camwear Colors



119 Sherwood Green



404 Red



133 Beige



414 Teal



168 Blue



416 Cranberry



186 Navy Blue



110 Black



431 Translucent Blue

Co-Polymer Colors



186 Navy Blue



416 Cranberry



915CP



1596CW



Personalization Available



915CW and 1596CW inside two PR314 Camracks.

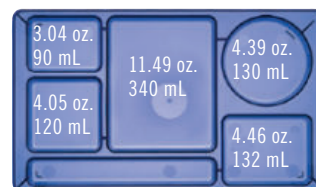

915CW & 915CP

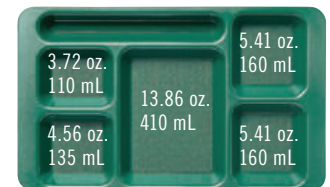

1596CW & 1596CP

CODE	DIMENSIONS W x L x D	LIST PRICE EA.
Camwear		
1596CW	9" x 15" x 7/8"	\$ 14.85
915CW	8 3/4" x 15" x 3/4"	14.85
Co-Polymer - BPA FREE		
1596CP	9" x 15" x 7/8"	8.50
915CP	8 3/4" x 15" x 3/4"	8.50

Case Pack: 24

COMPARTMENT SERVING TRAYS

- For meal delivery in correctional facilities.
- Compartment configurations designed to meet all menu requirements.

Camwear® 6-Compartment Colors:
Navy (186), Cranberry (416),
Yellow (145), Sherwood Green (119),
Beige (133), Black (110).

5-Compartment Colors: Beige (133),
Yellow (145).

Co-Polymer Not NSF Listed Color:
Tan (161).

Withstands Temperatures From

Camwear: -40° to 210°F.

Co-Polymer: -40° to 160°F.



NT9CP Co-Polymer Cup:
For details contact your
Cambro representative.

Camwear Colors



119
Sherwood Green



133
Beige



145
Yellow



186
Navy Blue



416
Cranberry



110
Black

Co-Polymer Color



161
Tan



10146CW



10146CW



10145CW

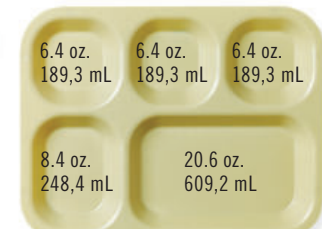

14105CW and 14105CP

CODE	DESCRIPTION	DIMENSIONS W x L x D	LIST PRICE EA.
Camwear			
10146CW	6 Compartments	10" x 14½" x 1⅝"	\$ 16.90
14105CW	5 Compartments	10⅞" x 13⅞" x 1⅞"	18.45
10145CW	5 Compartments	10" x 14½" x 1⅝"	18.40
Co-Polymer - BPA FREE			
14105CP	5 Compartments	10⅞" x 13⅞" x 1⅞"	8.85

Case Pack: 24

MEAL DELIVERY TRAYS

- Three deep-dish food compartments for large portions.
- Snap-on cover fits securely.
- Textured surface minimizes scratching.

Camwear® Colors:
Beige (133), Teal (414).
Lid Color: Clear (135).



Co-Polymer Not NSF Listed Colors:
Teal (414), Brown (167), Tan (161).
Lid Color: White (148).

Withstands Temperatures From
Camwear: -40° to 210°F.
Co-Polymer: -40° to 160°F.



Camwear Colors



133
Beige

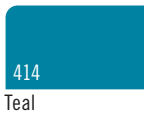

414
Teal

Co-Polymer Colors



161
Tan



167
Brown



414
Teal

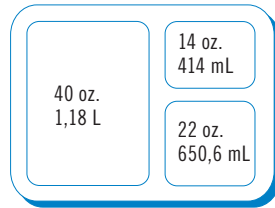

9113CW/9113CP

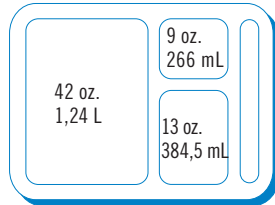

9114CW/9114CP

CODE	DESCRIPTION	DIMENSIONS W x L x D	LIST PRICE EA.
Camwear			
9113CW	3 Compartments	9" x 11" x 2 ¹ / ₁₆ "	\$ 19.80
9114CW	4 Compartments	9" x 11" x 2 ¹ / ₁₆ "	20.65
911CWC	Lid fits both trays	9" x 11" x 3 ¹ / ₁₆ "	14.00
Co-Polymer - BPA FREE			
9113CP	3 Compartments	8 ⁷ / ₈ " x 10 ¹ / ₁₆ " x 2 ⁵ / ₈ "	9.20
9114CP	4 Compartments	8 ¹⁵ / ₁₆ " x 10 ³ / ₄ " x 2 ⁵ / ₈ "	9.20
911CPC	Lid fits both trays	8 ¹⁵ / ₁₆ " x 10 ¹³ / ₁₆ " x 9 ¹ / ₁₆ "	5.00

Case Pack: 24

SEPARATOR® COMPARTMENT TRAY

- Six compartment tray designed specifically for in-cell feeding programs.
- Serve both hot and cold food from the same tray.
- Tray with cover separates each compartment to retain food temperature and reduce spills.
- Locking ridges on top of cover and bottom of tray ensure more secure stacking.

Camwear Color: Beige (133).
Lid Color: Clear (135).



Co-Polymer Not NSF Listed Colors:
Teal (414), Brown (167), Tan (161).
Lid Color: Translucent (190).

Withstands Temperatures From
Camwear: -40° to 210°F.
Co-Polymer: -40° to 160°F.



10146DCW



10146DCP

Camwear Color



133
Beige

Co-Polymer Colors



161
Tan

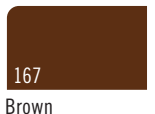

167
Brown



414
Teal

CODE	DESCRIPTION	DIMENSIONS W x L x D	LIST PRICE EA.
Camwear			
10146DCW	6 Compartments	10" x 14 ³ / ₁₆ " x 1 ¹ / ₁₆ "	\$ 21.75
10146DCWC	Lid fits 10146DCW	10 ³ / ₄ " x 14 ³ / ₄ " x 1 ¹ / ₁₆ "	11.60
Co-Polymer - BPA FREE			
10146DCP	6 Compartments	9 ¹⁵ / ₁₆ " x 13 ¹⁵ / ₁₆ " x 1 ¹ / ₁₆ "	11.80
10146DCPC	Lid fits 10146DCP	10 ¹ / ₁₆ " x 14 ¹ / ₁₆ " x 1 ¹ / ₁₆ "	6.85

Case Pack: 24



TRAY ON TRAY MEAL DELIVERY SYSTEM

Base Tray

- Combine hot and cold food portions into a reusable, single service unit.
- Works as a tray or for in-cell feeding with the insert tray.
- Base tray has 5 compartments with 1 compartment for nesting the insert tray.

Camwear® Color: Beige (133).



Co-Polymer Not NSF Listed Colors: Brown (167), Tan (161).

Withstands Temperatures From
Camwear: -40° to 210°F.
Co-Polymer: -40° to 160°F.



1411CW

Camwear Color

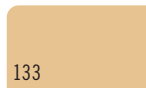

133
Beige

Co-Polymer Colors

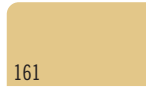

161
Tan



167
Brown

11.8 oz. 349 mL	6.7 oz. 198,1 mL	6.7 oz. 198,1 mL
11.8 oz. 349 mL	23.6 oz. 697,9 mL	

1411CW/1411CP



1411CW base tray with 853FH insert tray

CODE	DESCRIPTION	DIMENSIONS W x L x D	LIST PRICE EA.
Camwear			
1411CW	5 Compartments	10 ⁹ / ₁₆ " x 14 ³ / ₈ " x 1 ¹ / ₄ "	\$ 21.60
Co-Polymer - BPA FREE			
1411CP	5 Compartments	10 ⁹ / ₁₆ " x 14 ³ / ₈ " x 1 ¹ / ₄ "	8.30

Case Pack: 24

Insert Trays

- Eight trays efficiently fit on a standard sheet pan or in an 18" x 26" (45,5 x 65,5 cm) wire rack.

Camwear Color: Beige (133).

Lid Color: Clear (135).



Co-Polymer Not NSF Listed Colors: Brown (167), Tan (161).
Lid Color: Translucent (190).

Heat Resistant Plastic Tray and Lid Color: Amber (150).

Withstands Temperatures From
Camwear: -40° to 210°F.
Co-Polymer: -40° to 160°F.
Heat Resistant Plastic:
-40° to 375°F.



853FCW



853FCP

Camwear Color

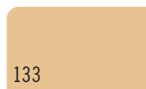

133
Beige

Co-Polymer Colors

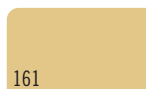

161
Tan



167
Brown

7 oz. 207 mL	21 oz. 621 mL
7 oz. 207 mL	

Heat Resistant Plastic Color

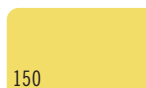

150
Amber

CODE	DESCRIPTION	DIMENSIONS W x L x D	LIST PRICE EA.
Camwear			
853FCW	3 Compartments	6 ⁵ / ₁₆ " x 8 ¹¹ / ₁₆ " x 1 ¹ / ₈ "	\$ 14.00
853FCWC	Lid for 853FCW	6 ³ / ₄ " x 8 ¹³ / ₁₆ " x 1 ¹ / ₄ "	7.45
Co-Polymer - BPA FREE			
853FCP	3 Compartments	6 ¹ / ₄ " x 8 ⁹ / ₁₆ " x 1 ¹ / ₈ "	7.20
853FCPC	Lid for 853FCP	6 ³ / ₄ " x 8 ¹³ / ₁₆ " x 1 ¹ / ₄ "	3.95
Heat Resistant Plastic			
853FH	3 Compartments	6 ⁵ / ₁₆ " x 8 ¹¹ / ₁₆ " x 1 ¹ / ₈ "	28.45
853FHC	Lid for 853FH	6 ³ / ₄ " x 8 ¹³ / ₁₆ " x 1 ¹ / ₄ "	16.40

Case Pack: 24



NON-SKID VERSA CAMTRAYS®



- Non-Skid Trays reduce waste, save money and provide a stable tray surface for meal delivery.
- Switching from paper tray mats will generate annual savings of over 50%.
- Green initiatives will get rapid results with the elimination of tons of trash each year.
- Non-Skid Camtrays provide a better grip for safer meal delivery.
- Dishwasher safe in low and high temperatures.
- Stacking lugs keep trays in place and ensure proper airflow between trays.

Colors:
 Black with Pebbled Black (382),
 Pearl Gray with Titan (381),
 Ivory with Sahara (380).

.....
 NSF Listed for splash zone only.

 Personalization available.
 Visit www.cambro.com for details.



Non-skid trays grip tray top items firmly.



CODE	DESCRIPTION	DIMENSIONS	LIST PRICE EA.
1418VC	Non-Skid Versa Camtray	14" x 18"	\$ 48.80
1520VC	Non-Skid Versa Camtray	15" x 20"	54.75

Case Pack: 12

Visit www.cambro.com/savemoney to see how much you can save by eliminating your purchase of paper mats.

Black with
 Pebbled
 Black (382)

Pearl Gray
 with Titan
 (381)

Ivory with
 Sahara
 (380)

NON-SKID VERSA CAMTRAYS WITH HANDLES

- Ergonomic handles allow for safe and elegant meal delivery.
- Non-skid surface eliminates the need for tray mats saving time and money.
- Trays fit within existing meal delivery carts that accommodate 14" x 18" or 15" x 20" trays.
- Dishwasher safe at high and low temperatures.
- Stacking lugs keep trays in place and ensure proper airflow between trays.
- 15" x 20" tray is ideal for room service.

Colors:
 Black with Pebbled Black (382),
 Pearl Gray with Titan (381),
 Ivory with Sahara (380).

.....
 Non-Skid Versa Camtrays for Room Service with Handles are covered by U.S. Patent D 683,191 S.

 NSF Listed for splash zone only.

 Personalization available.
 Visit www.cambro.com for details.



CODE	DESCRIPTION	DIMENSIONS	LIST PRICE EA.
1418VCH	Non-Skid Versa Camtray with handles	14" x 18"	\$ 51.00
1520VCRST	Non-Skid Versa Camtray with handles	15" x 20"	57.50

Case Pack: 12

CAMWEAR® TRAYS AND NON-SKID TRAYS

- Ideal for patient meal delivery and in high-traffic cafeterias.
- Scratch-resistant, made of durable Camwear.
- Non-skid surface eliminates the need for tray mats, saving time and money.
- Enhances stability, providing safer transport and service.
- Stacking lugs keep trays in place and ensure proper airflow between trays.
- Commercial dishwasher safe at high and low temperatures.
- Trays with handles are also available without non-skid surface.

Colors: Black (110), Dark Cranberry (488), Smoked Metal (485).

Not recommended for use in heated carts.

NSF Listed for splash zone only.



1520CWNSH

Black (110)

Dark Cranberry (488)

Smoked Metal (485)

CODE	DESCRIPTION	DIMENSIONS	LIST PRICE EA.
Non-Skid Trays			
1418CWNS	Without handles	14" x 18"	\$ 48.40
1520CWNS	Without handles	15" x 20"	54.25
1418CWNSH	With handles	14" x 18"	50.00
1520CWNSH	With handles	15" x 20"	57.00
Camwear Trays			
1418CWH	With handles	14" x 18"	42.60
1520CWH	With handles	15" x 20"	47.65

Case Pack: 12 1418CWNS, 1520CWNS InStock Color: Black (110), Smoked Metal (485), Dark Cranberry (488).
1520CWNSH InStock Color: Black (110), Smoked Metal (485).



1520CWNSH

DÉCOR SERIES EPICTREAD™ CAMTRAYS

- Provides the appearance of authentic wood grain, perfect modern healthcare facilities.
- Tray surface is embedded with clear EpicTread non-slip material, providing safe and spill-free patient meal delivery.
- EpicTread eliminates the use of tray mats, saving cost, waste and labor.
- Personalize a portion or an entire tray surface with a full color logo or design.
- Commercial dishwasher safe.

Colors: Charcoal Gray (815), Light Olive (820), Dark Oak (825), Light Oak (830).

Personalization with a minimum order of 144 trays.



CODE	DIMENSIONS	CASE PACK	LIST PRICE EA.
1216DCET	12" x 16"	12	\$ 37.70
1418DCET	14" x 18"	12	48.80
1520DCET	15" x 20"	12	54.75

Charcoal Gray (815)

Light Olive (820)

Dark Oak (825)

Light Oak (830)



MEAL DELIVERY WARE SYSTEM – THE HARBOR COLLECTION



- Attractive design provides a pleasant dining experience.
- Supports temperature maintenance.
- Available in six popular colors to complement any decor.
- Mugs and bowls fit Cambro disposable CamLids®.
- Made of durable polypropylene, won't chip or break.

- High temperature dishwasher safe.
- Dome fits 9" plate.
- Works with all Cambro Temperature Retention Systems, Camduction® Complete Heat System, Camtherm® Thermal Pellet System, Heat Keeper Insulating Base System and Camchiller® Pellet System.

Cambro insulated ware is not recommended for use in a microwave oven as this will increase the likelihood of staining and cracking, neither of which is covered under the manufacturers warranty.

Insulated Harbor bowl is covered by U.S. Patent D795,017 S.



Ergonomically correct handle fits three adult fingers.



CODE	MDSHD9	MDSHB5	MDSHB9	MDSHM8
DESCRIPTION	Insulated dome cover for 9" plate	Insulated small bowl	Insulated large bowl	Insulated mug
LID CODE	—	CLSM8B5, CLRSM8B5	CLSB9, CLRSB9	CLSSM8B5, CLSM8B5, CLRSM8B5
APPROX. CAPACITY	—	5 oz.	9 oz.	8 oz.
OUTSIDE DIAMETER	10¼"	3½"	4¾"	4½"
HEIGHT	3⅜"	2⅝"	2⅝"	4"
FULL-SIZE CAMRACK®	PR59314	16C414	9S318	16C414
CASE PACK	12	48	48	48
LIST PRICE EACH	\$ 23.75	\$ 4.10	\$ 4.10	\$ 4.10

InStock Color: White (148).

Harbor Meal Delivery Ware Colors:



110

Black



447

Meadow



485

Smoked Metal



487

Cranberry



148

White



497

Navy Blue

CLASSIC WHITE CERAMIC WARE

- Enhance dining experience with ceramic plates and bowls.
- Protect contents in bowls with disposable CamLids.
- Enhance operational efficiency: microwave, oven and freezer safe.
- Meets Society of Glass and Ceramic Decorators (SGCD) heavy metal standards.

Color: White (148)
 Disposable CamLids Color: Translucent (190)
 No Broken Cartons.



CODE	MDSM8CNL	MDSB5C	MDSB9C	MDSPLT9
DESCRIPTION	Ceramic Contoured Mug	Ceramic Small Bowl	Ceramic Large Bowl	Ceramic Plate
APPROX. CAPACITY TO RIM	8 oz.	5 oz.	9 oz.	—
OUTSIDE DIAMETER	4¾" with handle	3½"	4¾"	9"
HEIGHT	3⅜"	2¼"	2⅝"	1"
CAMLID CODE	CLNT12 with Straw Slot	CLSM8B5	CLSB9	—
CASE PACK	48	48	48	24
LIST PRICE PER CASE	\$ 468.00	\$ 225.00	\$ 288.00	\$ 243.00



MEAL DELIVERY WARE SYSTEM – THE SHORELINE COLLECTION



- Classic design, high performance, and unequalled safety at a budget-friendly price.
- Works with all Cambro Temperature Retention Systems, Camduction® Complete Heat System, Camtherm® Thermal Pellet System, Heat Keeper Insulating Base System and Camchiller® Pellet System.
- Mugs and bowls fit Cambro disposable CamLids®.
- Domes and delivery ware are made of durable polypropylene.

Cambro insulated ware is not recommended for use in a microwave oven as this will increase the likelihood of staining and cracking, neither of which is covered under the manufacturers warranty.



Insulated Meal Delivery Ware



CODE	MDS09	MDSL09	MDSM8	MDSB5	MDSB9	MDSB16
DESCRIPTION	Insulated dome covers 9" plate	Low profile insulated dome covers 9" plate	Mug	Sm. bowl	Lg. bowl	Entree bowl
LID CODE	—	—	CLSSM8B5, CLSM8B5, CLRSM8B5	CLSSM8B5, CLSM8B5, CLRSM8B5	CLSB9, CLRSB9	CLRSB16
APPROX. CAPACITY	—	—	8 oz.	5 oz.	9 oz.	16.9 oz.
OUTSIDE DIAMETER	10¼"	10¼"	3½" *	3½"	4¾"	5¾"
HEIGHT	3¾"	2¾"	4"	2⅝"	2⅝"	2⅝"
FULL-SIZE CAMRACK®	PR59314	PR59314	16C414	16C414	9S318	9S318
CASE PACK	12	12	48	48	48	48
LIST PRICE EACH	\$ 23.75	\$ 17.95	\$ 4.10	\$ 4.10	\$ 4.10	\$ 7.95

*MDSM8 Diameter 4½" with Handle. **InStock Colors.

Shoreline Meal Delivery Ware Colors:



Disposable Lids for Meal Delivery Ware



LID CODE	CLSM8B5	CLSB9	CLSSM8B5
DESCRIPTION	Sm. disp. lid	Lg. disp. lid	Disp. sip lid
FITS	MDSB5, MDSM8, MDSHB5	MDSB9, MDSHB9	MDSB5, MDSM8, MDSHM8
OUTSIDE DIAMETER	3⅞"	4⅞"	3⅞"
HEIGHT	⅝"	⅝"	1⅞"
CASE PACK	1,500	1,000	1,000
LIST PRICE PER CASE	\$ 118.25	\$ 99.00	\$ 99.00

CLSM8B5, CLSB9 Color: Translucent (190). CLSSM8B5 Color: White (148).
Sold in full cases only. No broken cartons.



TEMPERATURE RETENTION SYSTEMS



Cambro offers an array of products that support a variety of temperature retention systems. As each facility has its own separate needs and challenges, different serving solutions are needed.

MDESCDB9, HK39B, MDSL9, and MDS09
Colors: Meadow (447), Wheat (457), Speckled Gray (480), Cranberry (487), Navy Blue (497), Black (110), Smoked Metal (485)*.

MDSPC9 Color: Black (110).

MDSP9 Color: Dark Gray (477).

MDSPL Color: (000).

*Only available for Harbor Dome and Camduction Base.

MDSPL not NSF listed.

MDESCDB9 is covered by U.S. Patent D 630, 8975 S. and 8,263,906 B2.



Camduction®

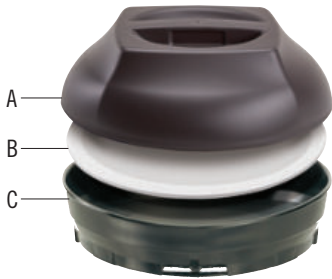

- A. Insulated Dome
- B. 9" Ceramic Plate
- C. Camduction Base

Insulated Base

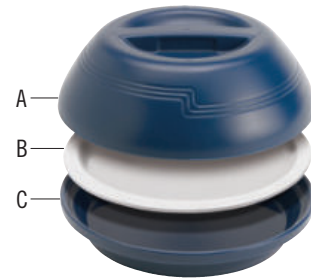

- A. Insulated Dome
- B. 9" Ceramic Plate
- C. Heat Keeper Insulated Base

Thermal Pellet

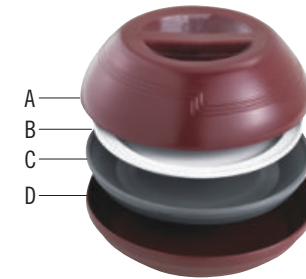

- A. Insulated Dome
- B. 9" Ceramic Plate
- C. Hot Thermal Pellet
- D. Underliner

Cold Pellet

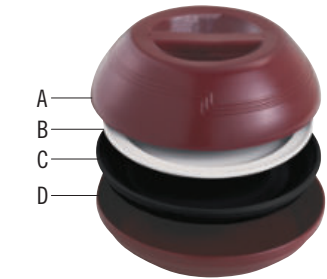

- A. Insulated Dome
- B. 9" Ceramic Plate
- C. Cold Pellet
- D. Underliner

Camduction Complete Heat System

The most efficient heat retention solution, holds hot food at safe temperatures 140°F or higher for up to 60 minutes.

- Camduction Bases are durable and dishwasher safe.
- Resistant to chips, cracks and breaks.
- Revolutionary technology eliminates errors or issues with spikes in voltage.



MDESCDB9

Camduction base holds 9" plate

OUTSIDE DIAMETER: 9³/₁₆"

OUTSIDE HEIGHT: 1¹⁵/₁₆"

FULL-SIZE CAMRACK®: PR59314

LIST PRICE EACH: \$ 122.50

Case Pack: 12

Heat Keeper Insulating Base System

The cost-effective solution for heat retention, holds temperature for 20 minutes or more.

- Resists stains, odors and scratches.



HK39B

Insulating base holds 9" plate

OUTSIDE DIAMETER: 9³/₈"

OUTSIDE HEIGHT: 1³/₈"

FULL-SIZE CAMRACK®: PR59314

LIST PRICE EACH: \$ 13.70

Case Pack: 12



TEMPERATURE RETENTION SYSTEMS

Camtherm® Thermal Pellet System

The perfect choice for maximum heat retention, holds temperature for 60 minutes or more.

- Holds heat at its core to keep hot foods at safe temperatures.
- Stays 20°F cooler on the edge than metal pellets to protect staff and patients from burns.
- Is a high-density plastic material that won't dent like metal pellets.



MDSP9
Thermal pellet holds 9" plate
OUTSIDE DIAMETER: 9½"
OUTSIDE HEIGHT: 1¾"
FULL-SIZE CAMRACK®: PR59314
LIST PRICE EACH: \$ 55.75
Case Pack: 12



MDSL9
Pellet underliner holds 9½" pellet
OUTSIDE DIAMETER: 9½"
OUTSIDE HEIGHT: 1⅝"
FULL-SIZE CAMRACK: PR59314
LIST PRICE EACH: \$ 10.80
Case Pack: 12



MDSPL
Camtherm thermal pellet lifter
OUTSIDE DIAMETER: 3⅝"
OUTSIDE HEIGHT: 3"
LIST PRICE EACH: \$ 105.00
Case Pack: 1

Camchiller® Pellet System

Keeps cold food below or at 40°F for up to 45 minutes when used with a chilled plate and insulated dome.

- Shatter-resistant at freezing temperature.
- Stackable for easy transport and storage.
- Can be used with or without an underliner.
- High-temperature dishwasher safe.



MDSPC9
Camchiller pellet holds 9" plate
OUTSIDE DIAMETER: 9½"
OUTSIDE HEIGHT: 1⅜"
FULL-SIZE CAMRACK: PR59314
LIST PRICE EACH: \$ 38.45
Case Pack: 12



MDSL9
Pellet underliner holds 9½" pellet
OUTSIDE DIAMETER: 9½"
OUTSIDE HEIGHT: 1⅝"
FULL-SIZE CAMRACK: PR59314
LIST PRICE EACH: \$ 10.80
Case Pack: 12

Domes, Plate Cover and Plate for all Cambro Temperature Retention Systems



CODE	MDS09 (NSF)	MDSL09 (NSF)	MDSHD9 (NSF)	909CW (NSF)	MDSPLT9
DESCRIPTION	Insulated dome covers 9" plate	Low profile insulated dome covers 9" plate	Insulated dome cover for 9" plate	Camwear® Camcover®	Ceramic plate
OUTSIDE DIAMETER	10¼"	10¼"	10¼"	10⅙"	9"
OUTSIDE HEIGHT	3⅜"	2¾"	3⅜"	2¾"	1"
FULL-SIZE CAMRACK	PR59314	PR59314	PR59314	PR59314	PR314
CASE PACK	12	12	12	12	24
LIST PRICE EACH	\$ 23.75	\$ 17.95	\$ 23.75	\$ 13.25	\$ 243.00 / case

MDS09, MDSL09 and MDSHD9 Colors: Meadow (447), Wheat (457), Speckled Gray (480), Cranberry (487), Navy Blue (497), Black (110), Smoked Metal (485)*. **909CW Colors:** Clear (152), Amber (153), Beige (133), Silver (486). **MDSPLT9 Color:** White (148). *Smoked Meal (485) only available for Harbor Dome. MDSPLT9 Sold in full cases only.



HEALTHCARE TUMBLER, SWIRL BOWL AND DISPOSABLE CAMLIDS®

Lido® Tumblers with Disposable Lids



The 6 & 9 ounce Lido tumblers are marked with 2 ounce increments from the top down for easy patient liquid intake recording.

TUMBLER CODE	LDT6	LDT9
LID CODE	CLST6	CL900P
TUMBLER CAPACITY	6 oz.	9 oz.
CASE PACK TUMBLER / LID	36 / 1,000	36 / 1,000
LIST PRICE PER CASE TUMBLER / LID	\$ 83.52 / \$ 84.25	\$ 95.40 / \$ 118.25

Color: Translucent (190). Sold in full cases only. No broken cartons.

Laguna® Tumblers with Disposable Lids



TUMBLER CODE	LT6	LT10	LT12
LID CODE	CLLT6	CLLT10	CLLT12
TUMBLER CAPACITY	6 oz.	10 oz.	12 oz.
CASE PACK TUMBLER / LID	36 / 1,500	36 / 1,000	36 / 1,000
LIST PRICE PER CASE TUMBLER / LID	\$ 87.48 / \$ 132.25	\$ 97.20 / \$ 107.75	\$ 108.00 / \$ 118.25

Color: Translucent (190). Sold in full cases only. No broken cartons.

Swirl Bowl with Disposable Lids



SWIRL BOWL CODE	SRB5CW (SRB5)
LID CODE	CLSRB5
SWIRL BOWL CAPACITY	5 oz.
CASE PACK BOWL / LID	24 / 1,000
LIST PRICE PER CASE BOWL / LID	\$ 66.00 (56.88) / \$ 177.00

Color: Clear (152). Made of (P.E.T.). Sold in full cases only. No broken cartons.

Colorware Tumblers with Disposable Lids



TUMBLER CODE	500P (500P2)	800P (800P2)	900P (900P2)	950P (950P2)
LID CODE	CLJ6	CL800P	CL900P	CL950P
TUMBLER CAPACITY	5.2 oz.	8 oz.	9.7 oz.	9.8 oz.
CASE PACK TUMBLER / LID	72 / 24 / 1,000	72 / 24 / 1,000	72 / 24 / 1,000	72 / 24 / 1,000
LIST PRICE PER CASE TUMBLER / LID	\$ 95.04 (32.88) / \$ 80.50	\$ 110.16 (39.36) / \$ 92.50	\$ 187.20 (68.40) / \$ 118.25	\$ 125.28 (45.60) / \$ 86.25

Color: Translucent (190). Sold in full cases only. No broken cartons.

Newport Tumblers with Disposable Lids



TUMBLER CODE	NT5	NT8	NT9	NT10	NT12
LID CODE	CLNT5	CLNT8	CLNT9	CLNT10	CLNT12
TUMBLER CAPACITY	6.4 oz.	8 oz.	9 oz.	10 oz.	12.6 oz.
CASE PACK TUMBLER / LID	36 / 1,500	36 / 1,000	36 / 1,000	36 / 1,000	36 / 1,000
LIST PRICE PER CASE TUMBLER / LID	\$ 68.40 / \$ 132.25	\$ 70.20 / \$ 84.25	\$ 77.76 / \$ 118.25	\$ 85.32 / \$ 107.75	\$ 89.28 / \$ 118.25

Color: Translucent (190). Sold in full cases only. No broken cartons.

CAMDUCTION® COMPLETE HEAT SYSTEM – HOT MEAL DELIVERY SYSTEM

Camduction innovative hot meal delivery system is fast and efficient. Camduction is perfect for any facility with a hot tray line system.

Camduction Charger covered by U.S. Patent 8,263,906 B2.
Camduction Base covered by U.S. Patent D630,897 S.

Camduction Charger comes with 1 year warranty.



Food Temperature Retention

*When used with heated plate, dome and Camduction Base.

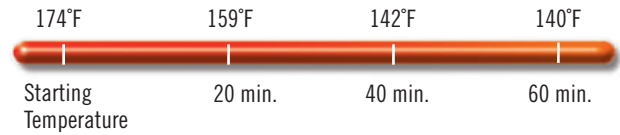

Quickly and efficiently heats up to 20 Camduction bases at one time. Initial start-up takes approximately 4 - 6 minutes.

Supports up to 5 trays per minute, improving operational efficiency.

Holds hot foods safe at 140°F or higher for up to 60 minutes. Based on voltage supply.

Energy efficient unit turns off after 45 minutes of inactivity.

Camduction charger is made of high-grade, durable stainless steel that remains cool to the touch.

Easy to operate: Red Slot LED indicates bases are heating. Green light indicates ready.

Independent functionality of each compartment reduces the risk of service interruption.

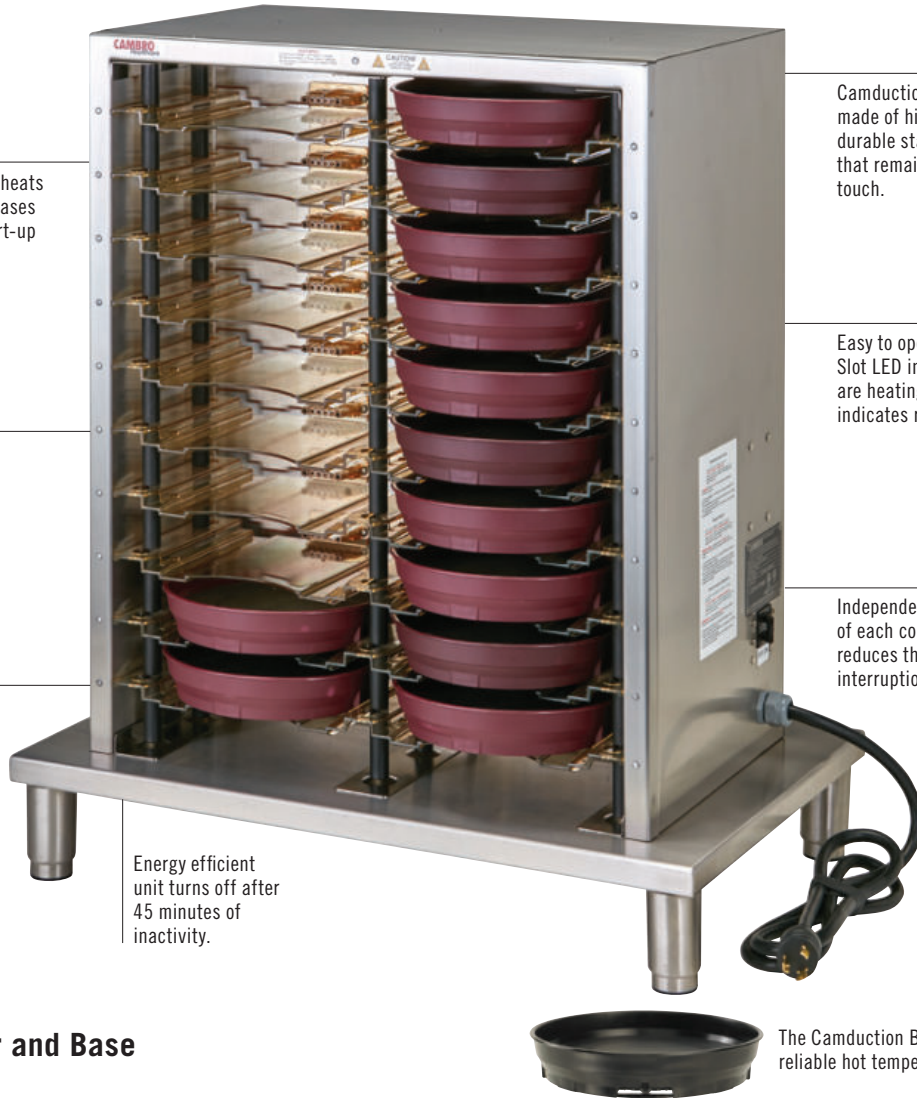

Camduction Charger and Base

CODE	MDSCDC9X1
DESCRIPTION	Camduction base charger, single phase
CAPACITY	20 Bases
OVERALL DIMENSIONS W x D x H	30" x 18 1/2" x 34 3/8"
VOLTAGE / PHASE	208-240 VAC, Single Phase
AMPS / HERTZ	18a, 50/60
PLUG CONFIGURATION	NEMA L6-30P
ELECTRICAL CORD	6 feet
INITIAL HEAT UP TIME	4 - 6 minutes*
ALL INDICATOR LIGHTS	LED
UNIT WEIGHT	108 lbs.
LIST PRICE EACH	\$ 10,615.00

Case Pack: 1 Color: Stainless Steel (000).

CODE	MDSCDB9
DESCRIPTION	Camduction base holds 9" plate
OUTSIDE DIAMETER	9 9/16"
OUTSIDE HEIGHT	1 15/16"
FULL-SIZE CAMRACK®	PR59314
CASE PACK	12
LIST PRICE EACH	\$ 122.50

The Camduction Base provides reliable hot temperature retention.

REUSABLE CAMLIDS®

- Save up to 75% in lid costs each year.
- Reduce your waste-stream by tons each year when you switch from disposables to reusables.
- Dishwasher safe.
- Made of durable polypropylene.
- Fits both Shoreline and Harbor Collection mugs and bowls.



CAMRACK® WASH AND STORE RACK

- Designed for safe and secure washing and storing of reusable CamLids, CLRSB9 and CLRSM8B5 only.
- Holds 36 reusable CamLids.
- 2 Wash and store racks fit in a full size base rack with 2 extenders.



Visit www.cambro.com/savemoney for a Customized Savings Calculator!

Reusable CamLids Color: White (148).
 Camrack Wash and Store Rack Color: Kelly Green (452).
 Camrack Base Full Size InStock Color: Soft Gray (151).
 Full Rack Cover InStock Color: Gray (180).

CLRWSR36 is covered under U.S. patent D 617,069.

Full Rack Cover not NSF certified.



CODE	DESCRIPTION	DIMENSIONS	CASE PACK	LIST PRICE EA.
Reusable CamLids		H x DIA.		
CLRSM8B5	Fits 8 oz. mug and 5 oz. bowl	2 7/8" x 3 3/16"	240	\$ 144.75
CLRSB9	Fits 9 oz. bowl	3 7/8" x 4 1/16"	240	193.00
CLRSB16	Fits 16 oz. bowl	3 7/8" x 5 1/2"	240	316.00
Accessories for CLRSM8B5 and CLRSB9		L x W x H		
CLRWSR36	Camrack wash and store rack for reusable lids	8 3/4" x 17 7/8" x 5 1/2"	4	34.10
BR578	Camrack full size base rack with 2 extenders	19 3/4" x 19 3/4" x 7 1/4"	4	94.75
DRC2020	Full rack cover	19 5/8" x 19 5/8" x 1 5/16"	1	76.00
Accessories for CLRSB16		L x W x H		
PR500	9 x 9 peg rack with 1 extender	19 3/4" x 19 3/4" x 5 5/8"	5	78.00
E3	Full size open extender	19 3/4" x 19 3/4" x 2"	12	18.80
CRPHDG2878	Full size square hold down grid	18 3/8" x 18 3/8"	6	37.10

Reusable CamLids sold in full cases only. No broken cartons.

AIR CURTAIN ULTRA™



The Air Curtain Ultra is a necessity for any Healthcare Room Service or Tray line operation. The ACU offers mobile refrigeration that can maintain cabinet temperatures of 40°F or below for 2 hours with the door open*. Perfect for staging cold sides, deserts, drinks or salads in your tray assembly area; operators can quickly access these items without risking temperature issues. Combine with our Camduction® system, Camtherm® Plate Heater and the rest of our healthcare product offering to fill your patient service needs.

- Stainless steel construction with welded base frame provides durability.
- Fully insulated cabinet and door for cooling efficiency.
- Multi directional cold air flow provides an even temperature throughout the entire cabinet.
- Intuitive control panel includes temperature set points, actual temperature indicator, clean condenser reminder and door open alarm.
- 270° door open.
- Space saving sliding door available for limited space applications.
- Air Curtain Ultra ships FOB and is exempt from any Cambro pre-paid freight programs.

Color: Stainless (000).

Capacity: 10/ea. 18" x 26" sheet pans or 20/ea. 13" x 18" sheet pans at 4.5" spacing.

Voltage/Phase: 120 / Single Phase.
Amps/Hertz: 6.5a / 60.

Plug Configuration: NEMA 5-15P.

*Dependent on ambient air temperature, and forced air near the unit.



Air Curtain Ultra is only available in North America.



Removable tray slides with tilt feature.

Recessed hand grips and rear mounted push bar.

1/2 HP Hi-Torque Condensing unit.

Advanced digital controls.



Optional, space-saving sliding door only requires 90° swing.



2 rigid and 2 swivel w/brake.

CODE	DESCRIPTION	DIMENSION W x D x H	UNIT WEIGHT	LIST PRICE EA.
ACU1826R	Right Door Swing	32" x 37½" x 78¾"	580 lbs.	\$ 21,190.00
ACU1826L	Left Door Swing	32" x 37½" x 78¾"	580	21,190.00
ACU1826RS	Right Sliding Door	32" x 37½" x 78¾"	580	23,230.00
ACU1826LS	Left Sliding Door	32" x 37½" x 78¾"	580	23,230.00

Case Pack: 1



MEAL DELIVERY CARTS FOR TRAY SERVICE



Transport meal trays from the kitchen to acute care patients, long-term acute care patients, nursing home residents, or correctional facility inmates during in-room service.

Enhance patient satisfaction with high-quality room service-style meals served quietly and efficiently.



- Ergonomic molded-in handle design provides comfort maneuvering.
- Molded-in rails ensure quiet meal delivery while bottom bumper protects the cart, walls, and furniture during transport.
- Features secure doors with a magnetic latch to hold door in place during service. Doors swing to 270 degrees. MDC1520T20 doors swing to 190 degrees when the end table is utilized.



- Thick insulation protects hot or cold meals, while venting increases air circulation to maintain food quality.
- Tough, one-piece double-wall polyethylene carts are durable and easy to clean, resisting rust, dents, chipping, or breakage.

- Features non-marking, quiet casters for easy maneuverability and to optimize patient rest. MDC1411T60 comes standard with plated casters.

- Lightweight doors allow for fast and quiet access to trays during service.

10-TRAY DUAL ACCESS AND SINGLE DOOR ROOM SERVICE CART — LOW PROFILE



Single door 10-Tray Meal Delivery Cart is covered by U.S. Patent D 723,237 S.



CODE	MDC1520S10D	MDC1520S10	MDC1520S10HD
TRAY SIZE	15" x 20"	15" x 20"	15" x 20"
TRAYS PER RAIL / RAIL SPACING	2 / 5¼"	2 / 5¼"	2 / 5¼"
TRAYS PER COMPARTMENT	10	10	10
EXTERNAL DIMENSIONS W x D x H	30⅞" x 38¼" x 42¾"	30⅞" x 38¼" x 42¾"	30⅞" x 38½" x 43½"
INTERNAL DIMENSIONS W x D x H	21⅞" x 31" x 26¼"	21⅞" x 31" x 26¼"	21⅞" x 31" x 26¼"
CASTER TYPE	Nylon, 5" 2 rigid, 2 swivel with brake	Nylon, standard casters 5" x 1¼"	6" Heavy Duty casters, 2 front rigid, 2 rear swivel with brake
UNIT WEIGHT	91 lbs.	78 lbs.	102 lbs.
LIST PRICE EACH	\$ 5,455.00	\$ 3,420.00	\$ 4,000.00

Case Pack: 1 Colors: Granite Gray (191) and Granite Sand (194).

Airpot and Condiment Station

- Holds three airpots for safe transport and service.
- Compartments are designed for stir sticks, napkins and a variety of condiments.
- Stain and odor resistant.
- Made of durable ABS material.
- Fits Cambro's 10-tray room service carts.

BSACS patent applied for.



CODE	DIMENSIONS W x D x H	CASE PACK	LIST PRICE EA.
BSACS	23¼" x 15⅝" x 6"	1	\$ 188.00

Color: Black (110). Airpots not included.



20-TRAY MEAL DELIVERY CART – LOW PROFILE



Marine rail is designed for use during service, not transport.



CODE	MDC1520S20	MDC1418S20
TRAY SIZE	15" x 20"	14" x 18"
TRAYS PER CART / PER COMPARTMENT	20 / 10	20 / 10
RAILS PER COMPARTMENT	5	5
TRAYS PER RAIL / RAIL SPACING	2 / 5½"	2 / 5½"
NUMBER OF COMPARTMENTS AND VENTS	2	2
NUMBER OF MENU CLIPS	2	2
MENU CLIPS - LOCATION	1 per door	1 per door
HANDLES - TYPE AND LOCATION	Molded in, each end	Molded in, each end
CASTER TYPE	6" nylon, 2 swivel with brake / 2 Rigid	Nylon, 5", 2 swivel w/brake, 2 rigid, offset
LATCHES	Lockable paddle latches, 1 per door, 2 total	2 internal nylon friction
EXTERNAL DIMENSIONS W x L x H	36¾" x 48¾" x 45"	32½" x 48½" x 44"
INTERNAL DIMENSIONS W x D x H	20¾" x 30¾" x 27½"	18¾" x 28¾" x 29"
REQUIRED DOOR WIDTH	36¾"	33"
UNIT WEIGHT	128 lbs.	141.5 lbs.
CASE PACK	1	1
COLORS (All carts with cream color doors)	Granite Gray (191), Granite Sand (194)	Slate Blue (401), Granite Gray (191), Granite Green (192), Granite Sand (194)
LIST PRICE EACH	\$ 5,140.00	\$ 5,060.00

TALL 20-TRAY MEAL DELIVERY CART WITH OPTIONAL END TABLE



Optimize space while allowing for a large capacity to serve meals with in-room service. Operators can conveniently use the end table to set up the tray and meal for the next patient as they manage the delivery process. The end table simply folds down and fits the side of the cart, allowing for easy accessibility.



CODE	MDC1520T20
TRAY SIZE	15" x 20"
TRAYS PER CART / PER COMPARTMENT	20 / 10
RAILS PER COMPARTMENT	10
TRAYS PER RAIL / RAIL SPACING	1 / 5"
HANDLES – TYPE AND LOCATION	Molded in, each end
CASTER TYPES	6" nylon, 2 swivel with brake / 2 Rigid
LATCHES	Lockable paddle latches, 1 per door, 2 total
EXTERNAL DIMENSIONS L x W x H	40 ⁷ / ₁₆ " x 28 ¹ / ₂ " x 64 ¹ / ₄ "
INTERNAL DIMENSIONS L x W x H	15 ⁷ / ₁₆ " x 21 ¹ / ₁₀ " x 50 ³ / ₄ "
REQUIRED DOOR WIDTH	28 ¹ / ₂ "
UNIT WEIGHT	143 lbs.
LIST PRICE EACH	\$ 6,370.00

Case Pack: 1 Colors: Granite Gray (191), Granite Sand (194). All carts with cream color doors.

Optional Accessory



MDCET

Optional End Table

Overall Exterior Dimensions L x W x H:
22³/₄" x 16¹/₂" x 2³/₅"

List Price Each: \$ 400.00

Color: Granite Gray (191).

16 AND 30 TRAY MEAL DELIVERY CARTS – TALL PROFILE



Marine rail is designed for use during service, not transport.



Tall Profile

CODE	MDC1520T30	MDC1418T30	MDC1520T16**	MDC1418T16**
TRAY SIZE	15" x 20"	14" x 18"	15" x 20"	14" x 18"
TRAYS PER CART / COMPARTMENT	30 / 10	30 / 10	16 / 16	16 / 16
RAILS PER COMPARTMENT	10	10	8	8
TRAYS PER RAIL / RAIL SPACING	1 / 5"	1 / 5"	2 / 5/4"	2 / 5/4"
NUMBER OF COMPARTMENTS	3	3	1	1
NUMBER OF MENU CLIPS	5	5	1	1
MENU CLIPS - LOCATION	Each door, each end	Each door, each end	Door	Door
HANDLES - TYPE AND LOCATION	Heavy-duty nylon, mounted 1 per end	Heavy-duty nylon, mounted 1 per end	Molded-in, back of cart	Molded-in, back of cart
CASTER TYPE	Nylon, 6", 2 rigid, 4 swivel with brake, offset	Nylon, 6", 2 rigid, 4 swivel with brake, offset	Nylon, 6", 2 rigid, 2 swivel with brake	Nylon, 6", 2 rigid, 2 swivel with brake
LATCHES	Friction catch, transit latches*	Friction catch, transit latches*	Lockable paddle latch	Lockable paddle latch
EXTERNAL DIMENSIONS W x L x H	29 1/4" x 60" x 63 3/8"	29 1/4" x 60" x 63 3/8"	27 1/2" x 37 19/32" x 58"	25 3/8" x 35 1/2" x 58"
INTERNAL DIMENSIONS W x D x H	15 1/4" x 21" x 50"	14 1/2" x 21 1/2" x 50"	20 3/8" x 30 5/8" x 43 3/5"	18 3/8" x 28 1/2" x 44 3/8"
REQUIRED DOOR WIDTH	30"	30"	30 3/8"	31"
UNIT WEIGHT	210 lbs.	214 lbs.	155 lbs.	99.5 lbs.
LIST PRICE EACH	\$ 8,250.00	\$ 8,180.00	\$ 4,750.00	\$ 4,630.00

Case Pack: 1 Cart Colors (All carts with cream color doors): Slate Blue (401), Granite Gray (191), Granite Green (192), Granite Sand (194). *Stainless steel transit latch at top of each door. MDC1418T16 are covered by U.S. Patent D 398,727. For lighter-duty applications, 30-tray carts may be ordered without the steel transit latches by using product code MDC1520T30NL or MDC1418T30NL. **MDC1520T16 comes in Granite Gray (191) and Granite Sand (194) only.

60-TRAY MEAL DELIVERY CART FOR CORRECTIONAL TRAY SERVICE



- For use in correctional facilities.
- Holds 60 each 1411CW or 1411CP Cambro Base Trays with 853 Insert Trays or 60 each 10146DCW or 10146DCP Separator Compartment Trays.
- Security features include security screws on handles, stop locks on door knuckles, security bolts for transit latches and caster carriage bolts with lock nuts.



CODE	MDC1411T60
TRAY SIZE	14" x 11" base tray 1411CW and 1411CP
TRAYS PER CART / PER COMPARTMENT	60 / 20
RAILS PER COMPARTMENT	10
TRAYS PER RAIL / RAIL SPACING	2 / 5"
NUMBER OF COMPARTMENTS	3
HANDLES - TYPE AND LOCATION	Heavy-duty aluminum with security screws, black finish, 1 per end
CASTER TYPE	6" heavy-duty casters, 2" wide tread, 2 swivel with brake, 2 rigid
LATCHES	Internal friction catch, 2 per door, transit latch*
EXTERNAL DIMENSIONS W x L x H	29¼" x 60" x 63¾"
INTERNAL DIMENSIONS W x D x H	14½" x 21½" x 50"
REQUIRED DOOR WIDTH	30"
UNIT WEIGHT	216 lbs.
LIST PRICE EACH	\$ 8,180.00

Case Pack: 1 **Colors:** Granite Gray (191), Granite Sand (194), Slate Blue (401).
 *Stainless steel transit latch at top of each door.

MEAL DELIVERY CARTS FEATURES AND CASTER CONFIGURATIONS

Standard Caster Configurations:

These caster configurations are designed to provide stability and maneuverability over uneven surfaces.

For optional caster configurations, contact your Cambro representative.

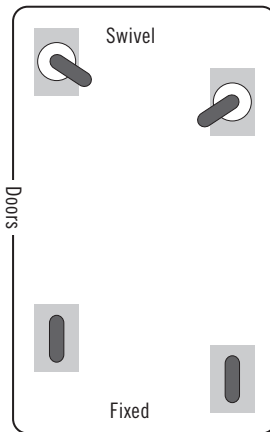

MDC1520S20, MDC1418S20,
MDC1520T20, MDC1411T60

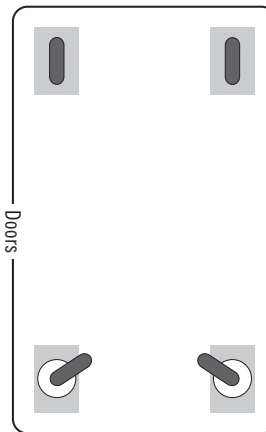

MDC1520S10, MDC1520S10D,
MDC1520T16, MDC1418T16,
MDC1520T20

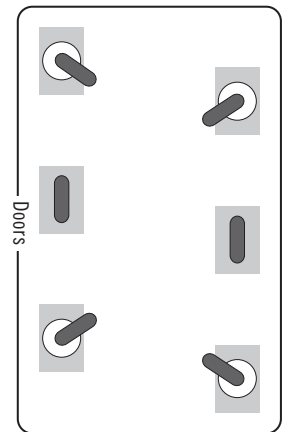

MDC1520T30, MDC1418T30

Handles

MDC1520S20, MDC1418S20



Molded in handles on each end of smooth transporting.

MDC1520T16, MDC1418T16



Molded in handles for easy transporting.

MDC1520T20, MDC1520T30,
MDC1418T30, MDC1411T60**



Heavy duty nylon handles are securely mounted and nested into each end.
 **MDC1411T60 has tamper resistant heavy duty aluminum tubing handles.

Lead in Casters



Castors are offset to ease movement over uneven surfaces. This is standard on MDC1520S10, MDC1520S10D, MDC1520S20, MDC1418S20, MDC1520T20, MDC1520T30, MDC1418T30 and MDC1411T60.

CAMSHELVING® HYGIENIC DRYING RACKS



- Keep tray line and warewashing areas organized and prevent wet stacking by storing newly washed products upright for faster drying before storing.
- Non-corrosive, break resistant and easy to assemble.
- Mobile racks allow for easy floor clean up and maneuverability.
- Drying cradles are removable and are high temperature dishwasher safe.
- Combine individual drying cradles to build custom drying racks on 24" deep Camshelving units.
- Lifetime warranty against rust and corrosion on posts and traverses.
- Drying Cradles are made of high impact ABS material.

*Camshelving Premium Series Color: Speckled Gray (480).

**Drying Cradle Color: Soft Gray (151).

Casters:

4 Premium Casters: (2 Swivel with Total Locking Brake, 2 Swivel with No Brake).



Vertical Drying Rack

- Securely holds various sizes of trays, cutting boards, baking sheet pans, lids and plates 8" to 13.5".
- Drying Cradles are installed directly onto shelf traverses.
- Fits 24" shelves.

7-Slot Drying Cradle is covered by U.S. Patent D 663,912 S.



CSDR7
7-Slot Drying Cradle
Width Per Slot: 1 5/16"



CODE	DESCRIPTION	DIMENSIONS D x L x H	HOLDING CAPACITY	CASE PACK	LIST PRICE EA.
Camshelving Premium*					
CPMU244875DRPKG	Vertical drying rack	24" x 48" x 75"	84 trays	1	\$ 1,895.00
CPMU246075DRPKG	Vertical drying rack	24" x 60" x 75"	105 trays	1	2,130.00
Drying Cradles**					
CSDR7	7-Slot drying cradle	23 1/2" x 10 1/4" x 3 3/4"		1	75.25
CSDR73	7-Slot drying cradle	23 1/2" x 10 1/4" x 3 3/4"		3	226.00 (Case price)

Drying Cradles fit on Camshelving Premium Series, mobile or stationary 24" deep shelves to 72" in length.

Package Includes: Pre-assembled mobile post kits, 6 traverses for each model, 12 or 15 drying cradles and premium swivel casters with total locking brake. Assembly required.



CPMU244875DRPKG
Camshelving Premium



CAMSHELVING® HYGIENIC DRYING RACKS

Angled Drying Rack

- Securely holds up to 128 meal delivery Pellets/Bases or a variety of food pan sizes, pots and kitchen wares.
- Drying Cradles are installed directly onto shelf traverses.
- Fits 24" shelves.

*Camshelving Premium Series Color: Speckled Gray (480).

**Drying Cradle Color: Soft Gray (151).

8-Slot Drying Cradle is covered by U.S. Patent D739,989 S.

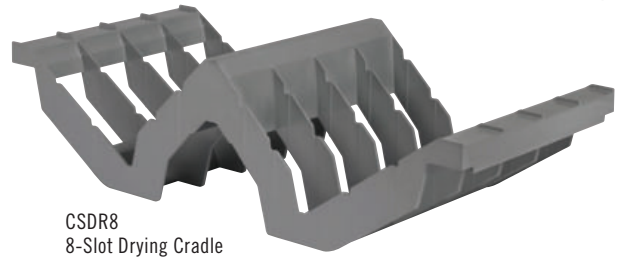

CSDR8
8-Slot Drying Cradle
Width Per Slot: 2 3/8"

CODE	DESCRIPTION	DIMENSIONS D x L x H	HOLDING CAPACITY	CASE PACK	LIST PRICE EA.
Camshelving Premium*					
CPMU244875PDPKG	Angled drying rack	24" x 48" x 75"	128 pellets and bases or 16 GN 1/1 food pans	1	\$ 2,220.00
Drying Cradles**					
CSDR8	8-Slot drying cradle	23 3/16" x 10 3/8" x 6 1/16"		1	60.50
CSDR84	8-Slot drying cradle	23 3/16" x 10 3/8" x 6 1/16"		4	242.00 (Case price)

Individual Drying Cradles fit on Camshelving Premium Series 24" deep shelves only, mobile or stationary.
Package Includes: Pre-assembled mobile post kits, 8 traverses, 16 drying cradles and premium swivel casters with total locking brake. Assembly required.



CPMU244875PDPKG
Camshelving Premium

Dome Drying Rack

- Securely holds 100 meal delivery domes.
- Drying Cradles are installed directly onto shelf traverses.
- Fits 24" shelves.

*Camshelving Premium Series Color: Speckled Gray (480).

**Drying Cradle Color: Soft Gray (151).

10-Slot Drying Cradle is covered by U.S. Patent D 736,488 S.

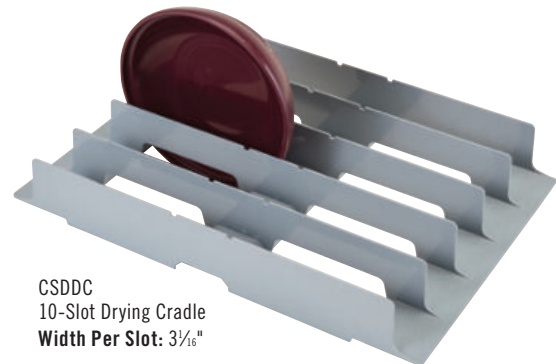

CSDDC
10-Slot Drying Cradle
Width Per Slot: 3 1/8"

CODE	DESCRIPTION	DIMENSIONS D x L x H	HOLDING CAPACITY	CASE PACK	LIST PRICE EA.
Camshelving Premium*					
CPMU243675DDPKG	Dome drying rack	24" x 36" x 75"	100 domes	1	\$ 1,950.00
Drying Cradles**					
CSDDC24	10-slot drying cradle	23 1/2" x 16 1/3" x 3 3/8"		1	87.50
CSDDC245	10-slot drying cradle	23 1/2" x 16 1/3" x 3 3/8"		5	434.00 (Case price)

Individual Drying Cradles fit on Camshelving Premium 24" deep shelves only, mobile or stationary.
Package Includes: Pre-assembled mobile post kits, 10 traverses, 10 drying cradles and premium swivel casters with total locking brake. Assembly required.



CPMU243675DDPKG
Camshelving Premium

CAMBRO® EQUIPMENT COLOR CHART

Cambro provides a wide selection of colors to help you coordinate with your decor and color code items to simplify use.

Color selections vary by product. Please see individual products for specific colors offered.



Gray (180)



Coffee Beige (157)



Hot Red (158)

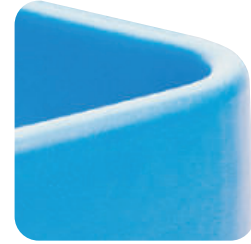

Cold Blue (159)



Speckled Gray (480)



Dark Taupe (417)



Brick Red (402)



Navy Blue (186)



Granite Gray (191)



Granite Sand (194)



Slate Blue (401)



Charcoal Gray (615)



Dark Brown (131)



Granite Green (192)



Black (110)



Kentucky Green (519)



Download the Cambro App!

Access helpful Cambro tools and resources on the go with the Cambro App.

Customize a tray, find the right lid for your containers, play the trivia challenge to win free products and more!

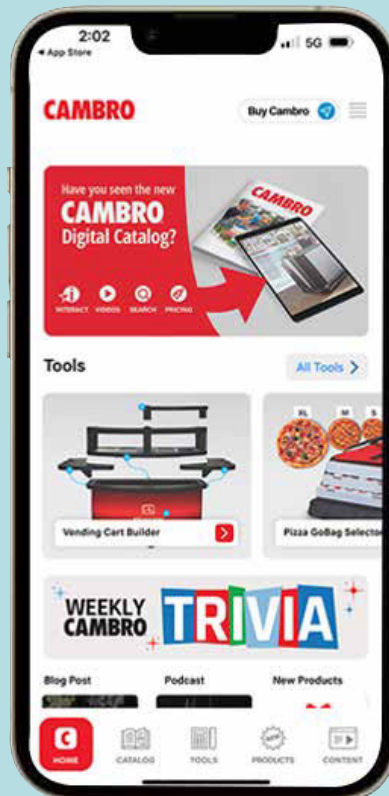

CAMBRO U.S.A.
5801 Skylab Road, Huntington Beach, CA 92647 P.O. Box 2000, Huntington Beach, CA 92647-2000
Telephone: (714) 848-1555 **Toll Free:** (800) 854-7631 **FAX:** (714) 842-3430
Customer Service: (800) 833-3003
© Cambro Manufacturing Company. Printed in the U.S.A.
All prices are in US dollars. All prices are subject to change without prior notice.

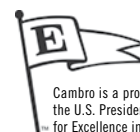

Cambro is a proud recipient of the U.S. President's E-Award for Excellence in Exporting.